



SINCE 1956

kappamoto.com



# MOTORCYCLE ACCESSORIES

→ EXPORT APPLICATION CHART  
03/2019

#RIDEYOURLIFE



## →INDEX

<b>02</b> <del>03</del>	THE COMPANY
<b>04</b> <del>23</del>	HARD BAGS
<b>24</b> <del>53</del>	SOFT BAGS
<b>54</b> <del>67</del>	VARIOUS ACCESSORIES
<b>68</b> <del>69</del>	TECHNICAL ACCESSORIES
<b>70</b> <del>77</del>	UNIVERSAL SCREEN & SPOILER
<b>78</b> <del>80</del>	DISPLAYS
<b>81</b> <del>185</del>	SPECIFIC EQUIPMENT FOR MOTORCYCLES AND SCOOTERS
<b>186</b> <del>214</del>	PLATES & SPARE PARTS
<b>215</b> <del>221</del>	MOUNTING EXAMPLES
<b>222</b> <del>223</del>	APP KAPPA RIDERS
<b>224</b> <del>225</del>	GENERAL CONDITION OF SALES



## → BRAND MISSION

Deviating from your normal path, venturing into the unknown, travelling longer distances or simply challenging the daily traffic to reach the office.

For Kappa it doesn't matter. As the most important thing is that you do it in full comfort and safety and that you do it on two wheels, in your own individual way. For 60 years Kappa has devoted all its efforts to improve the lives of riders. Roads, open spaces and horizons have become the central characters. Our history, and that of our products, are just a backdrop to each individual rider all over the world. Kappa chose to express and share its passion for two wheels, working hard day by day, trip after trip, for every solution, with every material, devoting everything to those who live their lives on their motorcycle.

Kappa symbolizes the values of quality and reliability associated with Italian manufacturing, which is universally recognized worldwide for its distinctive features. Choosing to merge artisan culture, a passion for motorcycles and innovative design, we are able to offer to the marketplace cutting-edge products, designed to ensure comfort and safety, guaranteed by a team with more than half a century of history and experience. With a market presence of almost almost sixty years, Kappa's experience can be considered one of the most solid and viable in the production of accessories for the world of motorcycling. After the success of the first top-case (N9900) in 1980, production has been extended and specialized, thanks to the desire to satisfy every riding need. This ultimately evolved into the creation of a wide range of racks, windshields, screens, engine guards, backpacks, helmets and accessories with a modern and innovative design, able to meet the expectations of the modern rider, ensuring a perfect quality to price ratio.

# → HARD BAGS

## MONOKEY® FITTING SYSTEM



Monokey® is the fitting system for panniers and top cases most famous both for bikers and scooter riders all over the world.

Patented by GIVI, adopted by KAPPA, the Monokey® has introduced the possibility to operate with only one key both for the opening of the top case and the detachment of the case from the fitting plate. It is universally famous for its mechanic characteristic, that permits the user to travel in complete security and also for an adventure use, thanks to the high level of rigidity of the system, combined with compact and light components.

The secret is the uniform distribution of the load on the plate surface, guaranteed by the three fitting points, which are placed in such a way to obtain the widest possible contact surface. The damping of oscillating and vibration and the contact between the bottom shell and the plate are assured by four spacers made of elastic material, which is particularly resistant to extreme weather and temperature variation. Thanks to these solutions a high level of reliability of the fitting is guaranteed even under the heaviest stresses and strains over the years.

## MONOLOCK® FITTING SYSTEM



Projected to offer a wider range of applications and uses of the top-cases, the Monolock® system has been conceived for lighter vehicles, such as scooters and maxi-scooters, used mainly for short/mid range commuter transport requirements. The Monolock®, introduced by GIVI, follows the same philosophy that defines the Monokey® fitting system, like the opening of the case top shell and the detachment of the case from the plate with one key only- thought to support less weight, without losing nothing in reliability and performances, but obtaining characteristics of lightness and more reduced overall.

## RETRO-FIT FITTING SYSTEM



RETRO-FIT is the new mounting system that opens new opportunities for the rider, allowing him to attach a set of aluminum K-Venture side cases to any existing KL and KLR mounts, originally designed for Monokey® cases. With this quick and secure adapter, it takes seconds to attach and detach the cases, without using any tools: the bottom part slides over the prongs on the bracket, while the top part is secured using two quick release fasteners, that fit to the included support which replaces the standard Monokey® locking wedge.

## MONOKEY® SIDE FITTING SYSTEM



This system represents an interesting alternative for the biker interested in mounting on his bike a pair of panniers.

The innovative elements that characterize the Monokey® Side can be recognized by the shape of the inclined holder and by the two fixing points, composed by "sleds". The latter receive the disengagement movement from the case release button and determine a significant and further increase on overall stability. The Monokey® Side allows to obtain a major adhesion of the case to the side of the motorcycle, improving the aerodynamic aspect.

As the two previous systems, also the Monokey® Side makes use of the comfortable and rapid opening system and release with the same key.

## FIXED FITTING SYSTEM



This fitting system, developed by KAPPA, is the most universal from the ones previously described. Designed for scooter boxes from the KCY25 range and for the model KCY14N for bicycles, it uses the bottom as a base for a secure and stable fitting on all vehicles equipped with luggage carrier. The kit is complete of metallic supports and screws. With very simple modifications, practicable by the user, the KCY25 and KCY14N top-cases can become compatible with the original luggage carriers present on the market.

→CASES  
MONOKEY®



KVE58\_



KVE48\_



KVE42\_



KGR52\_



KGR46\_PACK2



KGR33\_PACK2



K56\_



K53N



K49\_



K48N



K40N



K22N

→CASES  
MONOKEY SIDE®



K33N

→CASES  
RETRO-FIT SYSTEM



KVE37\_PACK2

→ HARD BAGS  
**MONOKEY®**

→ HARD BAGS



KVE58A



KVE58B

→ **KVE58A\_ K-VENTURE**

MONOKEY®

- KVE58A** MONOKEY® top-case capacity 58 ltr in 1.5mm thick natural aluminium, with polymer edges and profiled aluminium internal reinforcements
- KVE58B** MONOKEY® top-case capacity 58 ltr in 1.5mm thick aluminium, black painted, with polymer edges and profiled aluminium internal reinforcements

OPTIONAL

- WA406S** Waterproof cargo-bag
- TK767** Internal /external bag 54 ltr for KVE58 K-Venture
- K639** Polyurethane backrest, black colour
- E161K** Inner elastic carrying net
- E162K** Support in stainless steel for thermal flask. Compatible with KVE58 / KVE42 / KVE37 and KGR33 / KGR46
- KS410** Universal Trolley Base for MONOKEY® top-cases. To be combined with a MONOKEY® fitting plate. Security Lock system
- KS350** Pair of Adventure Straps belts, maximum traction load 100 kg

WA406S

TK767

K639

E161K



TECH INFO

--	--	--	--	--	--	--



KVE48A



KVE48B

→ **KVE48AN\_ K-VENTURE**

MONOKEY®

- KVE48AN** MONOKEY® top-case capacity 48 ltr in 1.5mm thick natural aluminium, with polymer edges and profiled aluminium internal reinforcements
- KVE48BN** MONOKEY® top-case black line capacity 48 ltr in 1.5mm thick aluminium, black painted, with polymer edges and profiled aluminium internal reinforcements

OPTIONAL

- WA406S** Waterproof cargo-bag
- K637** Polyurethane backrest, black colour
- E161K** Inner elastic carrying net
- E162K** Support in stainless steel for thermal flask. Compatible with KVE58 / KVE42 / KVE37 and KGR33 / KGR46
- KS410** Universal Trolley Base for MONOKEY® top-cases. To be combined with a MONOKEY® fitting plate. Security Lock system
- KS350** Pair of Adventure Straps belts, maximum traction load 100 kg

WA406S

K637

E161K

E162K



TECH INFO

--	--	--	--	--	--	--





KVE42A



KVE42B

## KVE42A\_ K-VENTURE

MONOKEY®

**KVE42A** MONOKEY® top-case capacity 42 ltr in 1.5mm thick natural aluminium, with polymer edges and profiled aluminium internal reinforcements

**KVE42B** MONOKEY® top-case capacity 42 ltr in 1.5mm thick aluminium, black painted, with polymer edges and profiled aluminium internal reinforcements

### OPTIONAL

<b>WA406S</b>	Waterproof cargo-bag
<b>K637</b>	Polyurethane backrest, black colour
<b>E162K</b>	Support in stainless steel for thermal flask. Compatible with KVE58 / KVE42 / KVE37 and KGR33 / KGR46
<b>KS410</b>	Universal Trolley Base for MONOKEY® top-cases. To be combined with a MONOKEY® fitting plate. Security Lock system
<b>E168K</b>	InnerelastickingnetforKVE42A-KVE42BK-VENTURE
<b>KS350</b>	Pair of Adventure Straps belts, maximum traction load 100 kg

WA406S

K637

E162K

KS410



### TECH INFO



→ HARD BAGS



KVE37APACK2



KVE37BPACK2

## KVE37\_PACK2 K-VENTURE

RETRO FIT

**KVE37APACK2\*** Pair of side-cases capacity 37 ltr in 1.5 mm thick natural aluminium, with polymer edges and profiled aluminium internal reinforcements  
\*THEY CAN BE MOUNTED ON TUBULAR SIDE-CASE HOLDERS KL AND KLR. THE FITTING IS ENABLED THROUGH QUARTER TURN SCREWS

**KVE37BPACK2\*** Pair of side-cases capacity 37 ltr in 1.5 mm thick aluminium, black painted, with polymer edges and profiled aluminium internal reinforcements  
\*THEY CAN BE MOUNTED ON TUBULAR SIDE-CASE HOLDERS KL AND KLR. THE FITTING IS ENABLED THROUGH QUARTER TURN SCREWS

### OPTIONAL

<b>WA406S</b>	Waterproof cargo-bag
<b>TK768</b>	Internal /external bag 35 ltr for KVE37 K-Venture
<b>E162K</b>	Support in stainless steel for thermal flask. Compatible with KVE58 / KVE42 / KVE37 and KGR33 / KGR46
<b>KS350</b>	Pair of Adventure Straps belts, maximum traction load 100 kg.

WA406S

TK768

E162K

KS350



### TECH INFO



→ HARD BAGS  
**MONOKEY®**

→ HARD BAGS



KGR52



KGR52N

→ **KGR52\_GARDA** MONOKEY®

**KGR52\*** Top-case, capacity 52ltr, equipped with silver cover on top-shell.

\*WITHOUT PLATE: SEE ITEM K636  
 CANNOT BE FITTED ONTO PLATES WITH AN INSTALLED ELECTRICAL CONTACT FOR A STOP LIGHT KIT

**KGR52N\*** Top-case black line, capacity 52 ltr, equipped with black cover on top-shell.

\*WITHOUT PLATE: SEE ITEM K636  
 CANNOT BE FITTED ONTO PLATES WITH AN INSTALLED ELECTRICAL CONTACT FOR A STOP LIGHT KIT

OPTIONAL	
<b>K635</b>	Backrest
<b>K9915B</b>	Metal rack (black)
<b>KS150</b>	Universal Nylon Rack with fixing system with half-spheres to fit the feet to the different top-cases round shapes
<b>TK756</b>	Inner bag
<b>E125K*</b>	Kit of 4 rings for the fitting of the elastic net K9910. <small>*IN ORDER TO FIT THEM YOU MUST DRILL FOUR HOLES OF Ø 10MM</small>
<b>K9910N</b>	Elastic carrying net
<b>KSL101</b>	Set of 1 key locks with corresponding bush including under lock platels.
<b>KS410</b>	Universal Trolley Base for MONOKEY® top-cases. To be combined with a MONOKEY® fitting plate. Security Lock system



**TECH INFO**



## KGR46\_ / KGR33\_ GARDA

MONOKEY®



KGR46



KGR46N



KGR33







KGR33N

- KGR46\*** Top-case, capacity 46 ltr, equipped with silver cover on top-shell.  
**\*CANNOT BE FITTED ONTO PLATES WITH AN INSTALLED ELECTRICAL CONTACT FOR A STOP LIGHT KIT**
- KGR46PACK2\*** Set of two KGR46 Garda cases with the same key, equipped with a third key cylinder with the same key number of the two cases  
**\*CANNOT BE FITTED ONTO PLATES WITH AN INSTALLED ELECTRICAL CONTACT FOR A STOP LIGHT KIT**
- KGR46N\*** Top-case black line, capacity 46 ltr, equipped with black cover on top-shell.  
**\*CANNOT BE FITTED ONTO PLATES WITH AN INSTALLED ELECTRICAL CONTACT FOR A STOP LIGHT KIT**
- KGR46NPACK2\*** Set of two KGR46N Garda cases with the same key, equipped with a third key cylinder with the same key number of the two cases  
**\*CANNOT BE FITTED ONTO PLATES WITH AN INSTALLED ELECTRICAL CONTACT FOR A STOP LIGHT KIT**
- KGR33\*** Top-case, capacity 33 ltr, equipped with silver cover on top-shell  
**\*CANNOT BE FITTED ONTO PLATES WITH AN INSTALLED ELECTRICAL CONTACT FOR A STOP LIGHT KIT**
- KGR33PACK2\*** Set of two KGR33 Garda cases with the same key, equipped with a third key cylinder  
**\*CANNOT BE FITTED ONTO PLATES WITH AN INSTALLED ELECTRICAL CONTACT FOR A STOP LIGHT KIT**
- KGR33N\*** Top-case black line, capacity 33 ltr, equipped with black cover on top-shell  
**\*CANNOT BE FITTED ONTO PLATES WITH AN INSTALLED ELECTRICAL CONTACT FOR A STOP LIGHT KIT**
- KGR33NPACK2\*** Set of two KGR33N Garda cases with the same key, equipped with a third key cylinder  
**\*CANNOT BE FITTED ONTO PLATES WITH AN INSTALLED ELECTRICAL CONTACT FOR A STOP LIGHT KIT**

OPTIONAL	
<b>K632</b>	Backrest
<b>E125K*</b>	Kit of 4 rings for the fitting of the elastic net K9910. <b>*IN ORDER TO FIT THEM YOU MUST DRILL FOUR HOLES OF Ø 10MM</b>
<b>K9910N</b>	Elastic carrying net
<b>TK756</b>	Inner bag
<b>KSL101</b>	Set of 1 key locks with corresponding bush including under lock platels.
<b>K9914B</b>	Metal rack (black)
<b>E162K</b>	Support in stainless steel for thermal flask. Compatible with KVE58 / KVE42 / KVE37 and KGR33 / KGR46
<b>KS150</b>	Universal Nylon Rack with fixings system with half-spheres to fit the feet to the different top-cases round shapes
<b>KS410</b>	Universal Trolley Base for MONOKEY® top-cases. To be combined with a MONOKEY® fitting plate. Security Lock system



TECH INFO KGR46					
					
42 cm 31 cm 53,3 cm	46 lt.	10 Kg MAX LOAD	FULL FACE	TOP CASE	SIDE CASE

TECH INFO KGR33					
					
42 cm 23,4 cm 53,3 cm	33 lt.	10 Kg MAX LOAD	TOP CASE	SIDE CASE	

→ HARD BAGS  
**MONOKEY®**

→ HARD BAGS



K56N



K56NT

→ **K56N / K56NT**

MONOKEY®

- K56N** 55/56 ltr top-case with red reflectors, black embossed
- K56NT** 55/56 ltr top-case with smoked reflectors, black embossed

**OPTIONAL**

- TK756** Inner bag
- KS150** Universal Nylon Rack with fixing system with half-spheres to fit the feet to the different top-cases round shapes
- K640** Black backrest, with synthetic leather finish
- KC56\_---** Painted cover for K56 (standard colours)
- KS410** Universal Trolley Base for MONOKEY® top-cases. To be combined with a MONOKEY® fitting plate. Security Lock system

**TK756**



**KS150**



**KS410**



**KC56\_---**



Painted cover

G730

**TECH INFO**





K53N

→ **K53N** MONOKEY®

**K53N\*** Top-case, capacity 53 ltr, with transparent reflectors. Black embossed colour  
\*WITHOUT PLATE: SEE ITEM K636

OPTIONAL	
<b>K612</b>	Backrest
<b>V107**</b>	Specific led stop-light **CHECK THE TRAFFIC LAWS OF YOUR OWN COUNTRY BEFORE USING THIS STOP-LIGHT KIT ON PUBLIC ROADS.
<b>TK756</b>	Inner bag
<b>K9916</b>	Metal rack (black)
<b>KS150</b>	Universal Nylon Rack with fixings system with half-spheres to fit the feet to the different top-cases round shapes
<b>KS410</b>	Universal Trolley Base for MONOKEY® top-cases. To be combined with a MONOKEY® fitting plate. Security Lock system



**TECH INFO**

--	--	--	--	--



K49N

→ **K49N / K49NT** MONOKEY®

**K49N\*** Top-case, capacity 47 ltr, with red reflectors and black embossed cover  
\*WITHOUT PLATE: SEE ITEM K636  
ITEM SOLD IN PAIRS, THE PRICE IS TO BE INTENDED AS A UNIT PRICE

**K49NS\*** Top-case, capacity 47 ltr, with red reflectors, without cover  
\*WITHOUT PLATE: SEE ITEM K636  
ITEM SOLD IN PAIRS, THE PRICE IS TO BE INTENDED AS A UNIT PRICE

**K49NT\*** Top-case, capacity 47 ltr, with transparent reflectors and black embossed cover  
\*WITHOUT PLATE: SEE ITEM K636  
ITEM SOLD IN PAIRS, THE PRICE IS TO BE INTENDED AS A UNIT PRICE

OPTIONAL	
<b>KC49N</b>	Black embossed cover for K49NS
<b>K631</b>	Backrest
<b>V105**</b>	Specific led stop-light **CHECK THE TRAFFIC LAWS OF YOUR OWN COUNTRY BEFORE USING THIS STOP-LIGHT KIT ON PUBLIC ROADS.
<b>TK756</b>	Inner bag
<b>KSL101</b>	Set of 1 key locks with corresponding bush including under lock platels.
<b>KS410</b>	Universal Trolley Base for MONOKEY® top-cases. To be combined with a MONOKEY® fitting plate. Security Lock system



**TECH INFO**

--	--	--	--	--	--

→ HARD BAGS  
**MONOKEY®**

→ HARD BAGS



→ **K48** MONOKEY®

**K48N\*** Top-case, capacity 48ltr, black embossed colour, with red reflector  
\*WITHOUT PLATE: SEE ITEM K636  
ITEM SOLD IN PAIRS, THE PRICE IS TO BE INTENDED AS A UNIT PRICE

OPTIONAL	
<b>K611</b>	Backrest
<b>V90K**</b>	Stop-light kit ** CHECK THE TRAFFIC LAWS OF YOUR OWN COUNTRY BEFORE USING THIS STOP-LIGHT KIT ON PUBBLIC ROADS.
<b>TK756</b>	Inner bag
<b>K9912B</b>	Metal rack (black)
<b>KS410</b>	Universal Trolley Base for MONOKEY® top-cases. To be combined with a MONOKEY® fitting plate. Security Lock system

**TK756**

**KS410**



TECH INFO					



**K40N**

→ **K40** MONOKEY®

**K40N\*** Pair of panniers, capacity 40 ltr., black colour  
\*THESE ITEMS ARE SOLD IN PAIRS AND ARE NOT AVAILABLE INDIVIDUALLY. THEY CAN BE MOUNTED ON TUBULAR SIDE-CASE HOLDERS KL AND KLR

OPTIONAL	
<b>K622N902</b>	Painted lid cover
<b>TK756</b>	Inner bag

**TK756**



TECH INFO					



**K22N**

→ **K22** MONOKEY®

**K22N\*** Pair of panniers, capacity 22ltr, black embossed colour  
\*\* THESE ITEMS ARE SOLD IN PAIRS AND ARE NOT AVAILABLE INDIVIDUALLY.

TECH INFO			

→ HARD BAGS  
**MONOKEY® SIDE**



K33N

→ **K33N**

MONOKEY SIDE

**K33N\***

Pair of panniers, capacity 33ltr, equipped with the new MONOKEY® SIDE fitting system. Black colour  
\*ATTENTION: THIS CASE CAN BE MOUNTED ONLY WITH THE TUBULAR SIDE-CASE HOLDER KLX/KLXR.

OPTIONAL

**TK755**

Pair of internal polyester bags for K33N cases

**TK755**



TECH INFO



→ HARD BAGS  
**MONOLOCK®**



K47\_



K466\_



K46\_



K400\_



K355\_



K35\_



K30\_



K29\_



K28BAS



K26\_

→ HARD BAGS  
**FIXED SYSTEM FOR BICYCLE**



KCY25N



KCY14N



→ **K47N / K47NT / K47NN MANTA** **MONOLOCK®**



K47N



K47NT









K47NN

- K47N\*** Top-case, capacity 47 ltr, with red reflectors. Black embossed colour. Plate K628 and universal kit included.  
\*ITEM SOLD IN PAIRS, THE PRICE IS TO BE INTENDED AS A UNIT PRICE
- K47NT\*** Top-case, tech version, capacity 47 ltr, black colour, equipped with smoked reflectors. Plate K628 and universal kit included.  
\*ITEM SOLD IN PAIRS, THE PRICE IS TO BE INTENDED AS A UNIT PRICE
- K47NN\*** Top-case, capacity 47 ltr, with red reflectors and black cover. Plate K628 and universal kit included.  
\*ITEM SOLD IN PAIRS, THE PRICE IS TO BE INTENDED AS A UNIT PRICE

OPTIONAL	
<b>TK756</b>	Inner bag
<b>K633</b>	Polyurethane backrest, black colour
<b>V108K**</b>	Specific led stop-light ** CHECK THE TRAFFIC LAWS OF YOUR OWN COUNTRY BEFORE USING THIS STOP-LIGHT KIT ON PUBLIC ROADS.
<b>KSL101</b>	Set of 1 key locks with corresponding bush including under lock platels.
<b>KC47_ _ _</b>	Cover painted (standard and specific colours)



TECH INFO					
					
34,8 cm 43,6 cm 57,2 cm	47 lt.	3 Kg MAX LOAD	MODULAR	TOP CASE	PLATE

→ **K46N / K46NT** **MONOLOCK®**



K46N



K46NT

- K46N\*** Top-case, capacity 46 ltr, black colour, with red reflectors. Universal plate K628 included.  
\*ITEM SOLD IN PAIRS, THE PRICE IS TO BE INTENDED AS A UNIT PRICE
- K46NT\*** Top-case, capacity 46 ltr, black colour, with transparent reflectors. Universal plate K628 included.  
\*ITEM SOLD IN PAIRS, THE PRICE IS TO BE INTENDED AS A UNIT PRICE

OPTIONAL	
<b>TK756</b>	Inner bag
<b>K627</b>	Polyurethane backrest, black colour
<b>V101K**</b>	Stop-light kit ** CHECK THE TRAFFIC LAWS OF YOUR OWN COUNTRY BEFORE USING THIS STOP-LIGHT KIT ON PUBLIC ROADS.
<b>KSL101</b>	Set of 1 key locks with corresponding bush including under lock platels.



TECH INFO					
					
37 cm 41 cm 65 cm	46 lt.	3 Kg MAX LOAD	JET	TOP CASE	PLATE

→ HARD BAGS  
**MONOLOCK®**

→ HARD BAGS



K466N



K466NT



K466NT+KC466G126

→ **K466N / K466NT URBAN**

MONOLOCK®

**K466N\***

46 ltr MONOLOCK® top-case, black with red reflectors. Plate K628 and universal fitting kit included.

\*THE ITEM IS SOLD IN PACKS OF TWO PIECES EACH

**K466NT\***

46 ltr MONOLOCK® top-case, black with smoked reflectors. Plate K628 and universal fitting kit included.

\*THE ITEM IS SOLD IN PACKS OF TWO PIECES EACH

**OPTIONAL**

<b>KC466_---</b>	Specific painted cover for K466/ K466 Tech
<b>TK756</b>	Inner bag
<b>K638</b>	Backrest in polyurethane foam, with synthetic leather finish
<b>KSL101</b>	Set of 1 key locks with corresponding bush including under lock platels.

**KC466\_---**



**TK756**



**K638**



**KSL101**



**TECH INFO**



→ **K35N / K35NT**

MONOLOCK®

**K35N\***

Top-case, capacity 35 ltr, black colour, with red reflectors. Equipped with plate K628

\*ITEM SOLD IN PAIRS, THE PRICE IS TO BE INTENDED AS A UNIT PRICE

**K35NT\***

Top-case, capacity 35 ltr, black colour, with transparent reflectors. Complete with nylon mounting plate item K628

\*ITEM SOLD IN PAIRS, THE PRICE IS TO BE INTENDED AS A UNIT PRICE



K35N



K35NT

**OPTIONAL**

<b>K627</b>	Polyurethane backrest, black colour
<b>KSL101</b>	Set of 1 key locks with corresponding bush including under lock platels.

**K627**



**KSL101**



**TECH INFO**



## K400N / K400NT

MONOLOCK®



K400N



K400NT

### K400N\*

Black top-case 40 ltr, top-shell with carbon texture, embossed logo plate in a matt titanium colour and with red reflectors. Plate and universal fitting kit included (with Micro 3 lock set)

\*ITEM SOLD IN PAIRS, THE PRICE IS TO BE INTENDED AS A UNIT PRICE

### K400NT\*

Black top-case 40 ltr, top-shell with carbon texture, embossed logo plate in a matt titanium colour and with smoked reflectors. Plate and universal fitting kit included (with Micro 3 lock set)

\*ITEM SOLD IN PAIRS, THE PRICE IS TO BE INTENDED AS A UNIT PRICE

### OPTIONAL

<b>TK756</b>	Inner bag
<b>KSL101</b>	Set of 1 key locks with corresponding bush including under lock platels.
<b>KC403_---</b>	Painted cover for K400 (standard colours)
<b>K638</b>	Backrest in polyurethane foam, with synthetic leather finish

TK756



KSL101



KC403\_---

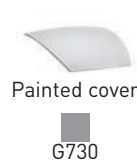

K638



### TECH INFO

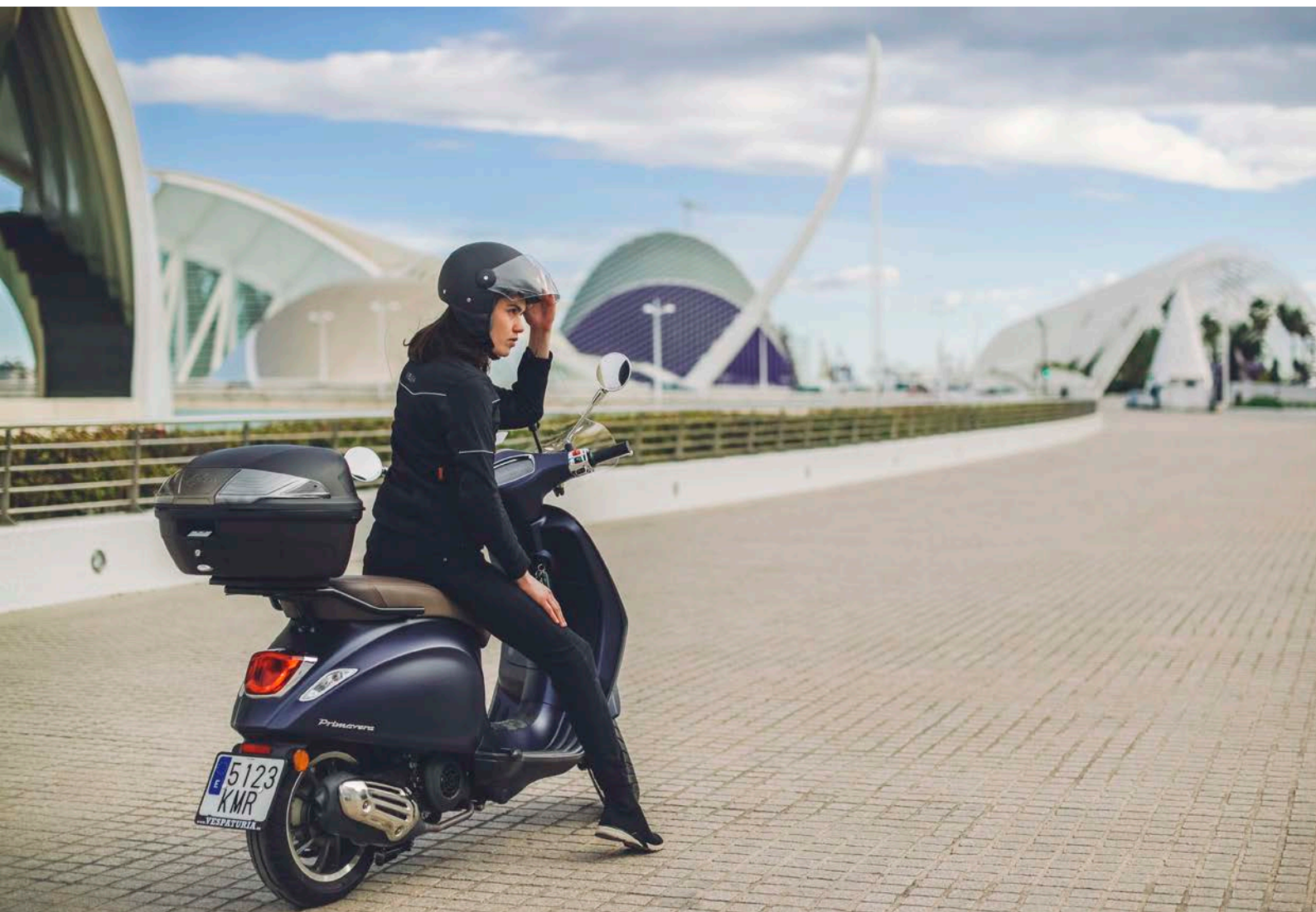

→ HARD BAGS  
**MONOLOCK®**

→ HARD BAGS



K355N



K355NT

→ **K355N / K355NT**

MONOLOCK®

**K355N\*** 35ltr MONOLOCK® top-case, black with red reflectors. Universal kit and plate K628 are included  
 \*ITEM SOLD IN PAIRS, THE PRICE IS TO BE INTENDED AS A UNIT PRICE

**K355NT\*** 35 ltr MONOLOCK® top-case, black with smoked reflectors. Universal kit and plate K628 are included  
 \*ITEM SOLD IN PAIRS, THE PRICE IS TO BE INTENDED AS A UNIT PRICE

OPTIONAL

**K638** Backrest in polyurethane foam, with synthetic leather finish

K638



TECH INFO



K30N



K30NT

→ **K30N / K30NT**

MONOLOCK®

**K30N\*** Top-case with red reflectors, capacity 30 ltr, black colour. Universal plate K628 included.  
 \*THESE ITEMS ARE SOLD IN PACKS OF 4 PIECES EACH, THE PRICE IS TO BE INTENDED AS A UNIT PRICE

**K30NT\*** Top-case, tech version, with smoked reflectors, capacity 30 ltr, black colour. Universal plate K628 included.  
 \*THESE ITEMS ARE SOLD IN PACKS OF 4 PIECES EACH, THE PRICE IS TO BE INTENDED AS A UNIT PRICE

OPTIONAL

**K630** Backrest

**KC30G730** ↘ Painted cover for K30 (standard colours)

K630



TECH INFO





## K29

MONOLOCK®

**K29N\*** Top-case, capacity 29 ltr, black colour, with red reflectors. Plate and universal kit included.  
\*THESE ITEM ARE SOLD IN PACKS OF 4 PIECES EACH, THE PRICE IS TO BE INTENDED AS A UNIT PRICE

**K29NT\*** Top-case, capacity 29 ltr, black colour, with smoked reflectors. Plate and universal kit included.  
\*THESE ITEM ARE SOLD IN PACKS OF 4 PIECES EACH, THE PRICE IS TO BE INTENDED AS A UNIT PRICE



### TECH INFO



## K28BAS

MONOLOCK®

**K28BAS\*** Top-case, capacity 28 ltr, black colour, with red reflector. Universal plate K628 included  
\*THESE ITEM ARE SOLD IN PACKS OF 4 PIECES EACH, THE PRICE IS TO BE INTENDED AS A UNIT PRICE



### OPTIONAL

**K603** Backrest

K603



### TECH INFO



## K26N

MONOLOCK®

**K26N\*** Top-case, capacity 26 ltr, colour black, with red reflectors. Equipped with plate K628  
\*THESE ITEMS ARE SOLD IN PAIRS AND ARE NOT AVAILABLE INDIVIDUALLY



### OPTIONAL

**K630** Backrest

**KSL101** Set of 1 key locks with corresponding bush including under lock platels.

K630

KSL101



### TECH INFO



→ HARD BAGS  
**MONOLOCK®**

→ HARD BAGS



→ **KCY14N - BIKE BOX**

FIXED SYSTEM

**KCY14N\***

Black fixed top-case complete with transparent reflector.

\*THESE ITEM ARE SOLD IN PACKS OF 4 PIECES EACH, THE PRICE IS TO BE INTENDED AS A UNIT PRICE



TECH INFO

	14	MAX LOAD	CASE WEIGHT	BIKE HELMET	TOP CASE

→ **KCY25N - BIKE BOX**

FIXED SYSTEM

**KCY25N ↘\***

Top-case, capacity 25 ltr, complete with reflector, equipped with universal fitting kit for mounting it on the carrier of the bicycles.

\*THESE ITEM ARE SOLD IN PACKS OF 4 PIECES EACH, THE PRICE IS TO BE INTENDED AS A UNIT PRICE



TECH INFO

	25	MAX LOAD	CASE WEIGHT	BIKE HELMET	TOP CASE

→ HARD BAGS  
KEY SETS



→ **SECURITY LOCK KIT** "LOCK BARREL KIT"  
(TO ALLOW ONE KEY  
OPENING OF MORE  
THAN ONE CASE)

- KSL101** Set of 1 key locks with corresponding bush including under lock platels.
- KSL102** Unification key kit Security Lock for 2 cases, including under lock plates.
- KSL103** Unification key kit Security Lock for 3 cases, including under lock plates.
- KSL105** Security Lock key set for 5 cases, including bushes. Only compatible with cases that are equipped with a Security Lock as standard. Can also be used in cases that are compatible with a Security Lock as an option, but it is important to purchase the corresponding under lock platelets
- Z2400CNGRK** Key blank not numbered for duplication with black handle
- Z277K** Plate below lock
- Z640RK** Plate below lock, 1 pcs.



→ **"LOCK BARREL KIT"** "LOCK BARREL KIT"  
(TO ALLOW ONE KEY  
OPENING OF MORE  
THAN ONE CASE)

- K501** 1-Set for 2 key locks with corresponding bush and keys with blue handle
- K501N** 1a-Set for 2 key locks with corresponding bush and keys with black handle
- K502** 2-Set for 3 key locks with corresponding bush and keys with blue handle
- K502N** 2a-Set for 3 key locks with corresponding bush and keys with black handle
- K500** 3-Key locks with corresponding bush and keys with blue handle
- K500N** 3a-Key locks with corresponding bush and keys with black handle
- Z661K** 4-Key locks with corresponding bush and keys with red handle
- Z156K** Lock barrel for case lock (thickness key 2 mm)
- Z661GK** 5-Blank key

→ HARD BAGS  
**MONOLOCK®**

→ HARD BAGS

→ HARD BAGS  
**HARD BAGS COMPLEMENTS**



■ →  
**TK767**

**TK767**

Internal /external bag 54 ltr for KVE58 K-Venture  
 The bag can also be used externally by attaching it to a top-case or a rack, using the elasticated straps supplied.

Characteristics:

- "Roll top" closure system to guarantee complete water resistance of the main internal compartment
- Shoulder strap
- 2 tubular elasticated straps with hooks



**TECH INFO**



■ →  
**TK768**

**TK768**

Internal /external bag 35 ltr for KVE37 K-Venture  
 The bag can also be used externally by attaching it to a top-case or rack , using the elasticated straps supplied

Characteristics:

- "Roll top" closure system to guarantee complete water resistance of the main internal compartment
- Shoulder strap
- 2 tubular elasticated straps with hooks



**TECH INFO**





■ →  
**TK755**



TK755 Inner bag

■ →  
**TK756**



TK756 Inner bag







→ SOFT BAGS  
**RACER RANGE**

RA300	RA301	RA305R	→NEW	→NEW
RA308R TANKLOCK	RA309R TANKLOCK	RA310	RA311R TANKLOCK	RA313
RA314 EASYLOCK	RA315	RA315BK	RA316	RA316BK
RA317BK	RA317	RA318BK	RA318	
RA319BK	RA319	RA320IGBK	RA320IG	RAW409
→NEW	→NEW	→NEW	→NEW	→NEW

→ SOFT BAGS

→ SOFT BAGS  
**RACER RANGE**



**TECH INFO**



■ → **RA300**

**RA300**

Tail pack with large central compartment

Features:

- External pockets
- Practical padded area that can be used as a backrest for passenger comfort
- Rain cover
- Reflective inserts
- Carrying shoulder strap

Material: Polyester with synthetic leather inserts and an EVA finish.

Mounting kit: Set of elastic straps for anchoring to the bike.



→ SOFT BAGS



**TECH INFO**



■ → **RA301**

**RA301**

Expandable tank bag

Features:

- Transparent smartphone holder
- Rain cover
- Pay toll Device holder
- Carrying shoulder strap
- Safety belt for securing to the handlebar

Material: Polyester with synthetic leather inserts and an EVA finish

Mounting kit: adjustable straps for non-metallic tanks / detachable magnets

**SPARE PARTS**

**TK718A** ↘

Adjustable fastening belts (of 2 pcs.)

**TK724A** ↘

Adjustable fastening belts

**TK707B** ↘

Shoulder belt





## → RA305R

### RA305R

Compact GPS system carrier that can be adapted to fit the majority of GPS devices available and the majority of mobile phones equipped with satellite navigation software.

Features:

- Waterproof zippers
- Rain cover

Material: Polyester with a synthetic leather finish  
Mounting kit: adjustable and universal securing straps with hook and loop fastening for attaching the carrier to a bike or scooter



#### TECH INFO



## → RA307R2 →NEW

### RA307R2

Leg bag.

Features:

- Adjustable thigh strap
- Front pocket
- Internal mobile phone compartment
- Reflective inserts and zip
- Water repellent fabric, anti-UV certified
- High contrast orange waterproof liner
- Available in two different colour: grey or black
- M.O.L.L.E. system on front

### RA307R2BK

Leg bag.

Features:

- Adjustable thigh strap
- Front pocket
- Internal mobile phone compartment
- Reflective inserts and zip
- Water repellent fabric, anti-UV certified
- High contrast orange waterproof liner
- Available in two different colour: grey or black
- M.O.L.L.E. system on front



#### TECH INFO



→ SOFT BAGS  
**RACER RANGE**



**TECH INFO**



■ → **RA308R TANKLOCK**

**RA308R**

Expandable tank bag with TANKLOCK system.

Features:

- Transparent map holder
- Removable smartphone holder that attaches to the lid
- Polypropylene internal reinforcement
- Shoulder strap for transportation
- Front handle
- Safety straps for securing to the handlebar
- Elasticated section at the rear
- Fluorescent orange raincover with transparent top section

Materials: 840D Polyester with eco-leather inserts

PLEASE CHECK THE "MY MOTORCYCLE" SECTION TO FIND THE FLANGE COMPATIBLE WITH YOUR SPECIFIC MODEL OF MOTORCYCLE.  
**TO BE COMBINED WITH THE SPECIFIC FLANGE BF\_\_K**



**SPECIFIC RANGE**

PLEASE CHECK THE "MY MOTORCYCLE" SECTION TO FIND THE FLANGE COMPATIBLE WITH YOUR SPECIFIC MODEL OF MOTORCYCLE



**TECH INFO**



■ → **RA309R TANKLOCK**

**RA309R**

Expandable TANKLOCK bag

Features:

- Generous central pocket
- Small front pocket
- Transparent smartphone holder/pocket
- Rain cover
- Carrying shoulder strap
- Reflective insert

Material: polyester with faux leather inserts and EVA lamination

Fitting kit: TANKLOCK system with a safety strap to attach the bag to the handlebar

PLEASE CHECK THE "MY MOTORCYCLE" SECTION TO FIND THE FLANGE COMPATIBLE WITH YOUR SPECIFIC MODEL OF MOTORCYCLE.  
**TO BE COMBINED WITH THE SPECIFIC FLANGE BF\_\_K**



**SPECIFIC RANGE**

PLEASE CHECK THE "MY MOTORCYCLE" SECTION TO FIND THE FLANGE COMPATIBLE WITH YOUR SPECIFIC MODEL OF MOTORCYCLE



## RA310

RA310

Pair of expandable side bags

Features:

- Reflective inserts
- Carrying shoulder strap
- Convenient side pocket for a drinks can
- Rain cover

Material: Synthetic leather inserts with the front pocket in an EVA finish  
 Fitting kit: Securing straps; two with hook and loop fastening, one central strap for safety and two elasticated straps with hooks

### TECH INFO



## RA311R TANKLOCK

RA311R\*

Expandable tank bag with TANKLOCK system.

Features:

- Transparent smartphone holder / pocket
- Transparent map holder / pocket
- Two side pockets
- Rain cover
- Carrying shoulder strap
- Reflective insert

Material: Polyester with faux leather inserts and EVA lamination  
 Fitting kit: TANKLOCK system with a safety strap to attach the bag to the handlebar

PLEASE CHECK THE "MY MOTORCYCLE" SECTION TO FIND THE FLANGE COMPATIBLE WITH YOUR SPECIFIC MODEL OF MOTORCYCLE.

\*TO BE COMBINED WITH THE SPECIFIC FLANGE BF\_K / NOT COMPATIBLE WITH FLANGE BF24K

### TECH INFO



**SPECIFIC RANGE**

PLEASE CHECK THE "MY MOTORCYCLE" SECTION TO FIND THE FLANGE COMPATIBLE WITH YOUR SPECIFIC MODEL OF MOTORCYCLE

→ SOFT BAGS  
**RACER RANGE**



**TECH INFO**



■ →  
**RA313**

**RA313**

Rucksack with thermoformed inserts

Features:

- Carrying handle for easy transportation
- Padded shoulder straps with adjustable belts at the chest and waist
- Inner pockets
- Mesh side pockets
- Rain cover
- Reflective inserts

Material: Polyester with EVA thermoformed inserts and reflective inserts



**TECH INFO**



■ →  
**RA314 EASYLOCK**

**RA314**

[Simboli2:à]

Pair of thermoformed Easylock side bags

Features:

- Protective "feet" on the base
- Rain cover
- Zip slider with a blocking lock
- Carrying handle
- Internal rubber straps to maintain load stability
- Net storage compartment inside the lid

Material: polyester with an EVA laminated polyester lining

Fitting system: Easylock. Fitting system for rapid attachment/detachment, to be combined with specific soft side bag holders via a plate with a key for attachment/detachment (Easylock plate).

To be combined with the specific holder TE\_\_\_\_K  
**TO BE COMBINED WITH THE SPECIFIC HOLDER TE\_\_\_\_K**



→ Fitting system: **EASYLOCK**

Fitting system for rapid attachment/detachment, to be combined with the specific side soft bags holders through a plate with key for attachment/detachment (Easylock plate). See the section **SPECIFIC RANGE** ([www.kappamoto.com](http://www.kappamoto.com)).



**SPECIFIC RANGE**

PLEASE CHECK THE "MY MOTORCYCLE" SECTION TO FIND THE FLANGE COMPATIBLE WITH YOUR SPECIFIC MODEL OF MOTORCYCLE





## RA315

### RA315

Expandable grey tank bag, mounted through magnets and straps, that can be also used as a backpack or a seat bag. It can be connected with the RA317 handlebar bag (using the M.O.L.L.E. system).

#### Features:

- Turns into a backpack using two fold-away straps
- Breathable back side
- Roll-down closure for water tightness
- High contrast orange waterproof liner
- Water repellent fabric, anti-UV certified
- Adjustable volume via straps or by connecting the RA317 handlebar bag (using the M.O.L.L.E. system)
- Clear, 24x18 cm front pocket for smartphones
- Carry handle
- Reflective zippers and prints

#### TECH INFO



## RA315BK

### RA315BK

Expandable black tank bag, mounted through magnets and straps, that can be also used as a backpack or a seat bag. It can be connected with the RA317 handlebar bag (using the M.O.L.L.E. system).

#### Features:

- Turns into a backpack using two fold-away straps
- Breathable back side
- Roll-down closure for water tightness
- High contrast orange waterproof liner
- Water repellent fabric, anti-UV certified
- Adjustable volume via straps or by connecting the RA317 handlebar bag (using the M.O.L.L.E. system)
- Clear, 24x18 cm front pocket for smartphones
- Carry handle
- Reflective zippers and prints

#### TECH INFO



→ SOFT BAGS  
**RACER RANGE**



→  
**RA316**

**RA316**

Pair of side bags

Features:

- Roll-down closure for water tightness
- High contrast orange waterproof liner
- Water repellent fabric, anti-UV certified
- Adjustable volume via straps on top, sides and bottom
- Padded front pocket (22x35 cm) for devices
- Carry handle
- Reflective zippers and prints

Mounting system: Double hook & loop straps, running under the seat



**TECH INFO**



→  
**RA316BK**

**RA316BK**

Pair of side bags

Features:

- Roll-down closure for water tightness
- High contrast orange waterproof liner
- Water repellent fabric, anti-UV certified
- Adjustable volume via straps on top, sides and bottom
- Padded front pocket (22x35 cm) for devices
- Carry handle
- Reflective zippers and prints

Mounting system: double hook & loop straps, running under the seat

**TECH INFO**



→ **RA317**



**RA317**

Grey handlebar mounted bag, that can also be connected and used in combination with the RA315 tank bag (using the M.O.L.L.E. system)

Features:

- High contrast orange waterproof liner
- Water repellent fabric, anti-UV certified
- Inner mesh pocket
- Reflective zippers and prints

Mounting system:

- Straps with double-D rings
- Comes with a belt to be used as a waist bag

**TECH INFO**



→ **RA317BK**



**RA317BK**

Black handlebar mounted bag, that can also be connected and used in combination with the RA315 tank bag (using the M.O.L.L.E. system)

Features:

- High contrast orange waterproof liner
- Water repellent fabric, anti-UV certified
- Inner mesh pocket
- Reflective zippers and prints

Mounting system:

- Straps with double-D rings
- Comes with a belt to be used as a waist bag

**TECH INFO**



→ SOFT BAGS  
**RACER RANGE**



**TECH INFO**



■ → **RA318** → NEW

**RA318**

- Tail bag.  
 Features:
- MML (Morphing Metal Lock) closure system. Patented
  - High contrast orange waterproof liner
  - Water repellent fabric, UV TESTED
  - Equipped with straps for use as a backpack
  - Reflective inserts and zip
  - Volume can be modified using the adjustable straps
  - Double handles for transport by hand
  - Equipped with 4 belt buckles for attachment to the saddle which automatically realign together once separated from the bag, thereby, freeing the base
  - Available in two different colour: grey or black



→ SOFT BAGS

■ → **RA318BK** → NEW

**RA318BK**

- Tail bag.  
 Features:
- MML (Morphing Metal Lock) closure system. Patented
  - High contrast orange waterproof liner
  - Water repellent fabric, UV TESTED
  - Equipped with straps for use as a backpack
  - Reflective inserts and zip
  - Volume can be modified using the adjustable straps
  - Double handles for transport by hand
  - Equipped with 4 belt buckles for attachment to the saddle which automatically realign together once separated from the bag, thereby, freeing the base
  - Available in two different colour: grey or black
  - M.O.L.L.E. system on front



**TECH INFO**





→ **RA319** →NEW

**RA319**

- Tail bag.  
Features:
- MML closure system (Morphing Metal Lock), patented
  - High contrast orange waterproof liner
  - Water repellent fabric, UV TESTED
  - Shoulder strap
  - Reflective inserts and zip
  - Volume can be modified by using the adjustable straps
  - Equipped with 4 belt straps for attachment to the saddle which automatically realign together once separated from the bag, thereby, freeing the base
  - Available in two different colour: grey or black
  - M.O.L.L.E. system

**TECH INFO**



→ **RA319BK** →NEW

**RA319BK**

- Tail bag.  
Features:
- MML closure system (Morphing Metal Lock), patented
  - High contrast orange waterproof liner
  - Water repellent fabric, UV TESTED
  - Shoulder strap
  - Reflective inserts and zip
  - Volume can be modified by using the adjustable straps
  - Equipped with 4 belt straps for attachment to the saddle which automatically realign together once separated from the bag, thereby, freeing the base
  - Available in two different colour: grey or black
  - M.O.L.L.E. system

**TECH INFO**



**MORPHING METAL LOCK PATENTED SYSTEM**

**MML (Morphing Metal Lock)** benefits from the “shape memory” of a special type of metal, used here as bars sewn internally that follow the movement of the closing flaps and can then be folded beneath the ends.

This operation enables hands to be moved out of the way without the bag opening and means the bag can be fully closed using the dedicated adjustable, crossover strap.

→ SOFT BAGS  
**RACER RANGE**



■ → **RA320IG TANKLOCK** → NEW

**RA320IG**

Tank bag with TANKLOCK system.

Features:

- Elasticated carrying net
- Retractable shoulder strap
- Reflective inserts and zip
- Double opening function so it can be used both as a shoulder bag and as a tank bag
- Water repellent fabric, UV TESTED
- High contrast orange waterproof liner
- Available in two different colour: grey or black
- M.O.L.L.E. system on front

PLEASE CHECK THE "MY MOTORCYCLE" SECTION TO FIND THE FLANGE COMPATIBLE WITH YOUR SPECIFIC MODEL OF MOTORCYCLE.



**TECH INFO**



**SPECIFIC RANGE**

PLEASE CHECK THE "MY MOTORCYCLE" SECTION TO FIND THE FLANGE COMPATIBLE WITH YOUR SPECIFIC MODEL OF MOTORCYCLE

■ → **RA320IGBK TANKLOCK** → NEW

**RA320IGBK**

Tank bag with TANKLOCK system.

Features:

- Elasticated carrying net
- Retractable shoulder strap
- Reflective inserts and zip
- Double opening function so it can be used both as a shoulder bag and as a tank bag
- Water repellent fabric, UV TESTED
- High contrast orange waterproof liner
- Available in two different colour: grey or black
- M.O.L.L.E. system on front

PLEASE CHECK THE "MY MOTORCYCLE" SECTION TO FIND THE FLANGE COMPATIBLE WITH YOUR SPECIFIC MODEL OF MOTORCYCLE.



**TECH INFO**



**SPECIFIC RANGE**

PLEASE CHECK THE "MY MOTORCYCLE" SECTION TO FIND THE FLANGE COMPATIBLE WITH YOUR SPECIFIC MODEL OF MOTORCYCLE

→ **RAW409** →NEW



**RAW409**

Waterproof tail bag.

Features:

- Equipped with padded shoulder straps for use as a backpack
- Double handles for transport by hand
- Internal pocket for carrying small objects
- Equipped with a name tag pocket
- Equipped with 4 belt straps for attachment to the saddle
- Reflective prints
- M.O.L.L.E. system

**TECH INFO**



# TANKLOCK SYSTEM



## → TANKLOCK SYSTEM

A quick attachment/detachment system that uses a specific kit to attach a flange to the tank cap, onto which the tank bag is then fixed. See the section See the MY MOTORCYCLE section ([www.kappamoto.com](http://www.kappamoto.com)) to check that there is a specific kit for your motorcycle.

BF \_\_ K Specific flange for fitting any of the TANKLOCK bags

BF01K	BF10K	BF18K	BF27K	BF35K
BF02K	BF11K	BF19K	BF28K	BF36K
BF03K	BF12K	BF20K	BF29K	BF37K
BF04K	BF14K	BF21K	BF30K	BF38K
BF05K	BF15K	BF22K	BF31K	BF39K
BF08K	BF16K	BF23K	BF32K	
BF09K	BF17K	BF24K	BF33K	



### SPECIFIC RANGE

PLEASE CHECK THE "MY MOTORCYCLE" SECTION TO FIND THE FLANGE COMPATIBLE WITH YOUR SPECIFIC MODEL OF MOTORCYCLE

#### APRILIA

BF02K	RS 125
BF02K	Shiver 750 / Shiver GT 750 (07 > 12) / ABS (09 > 12)
BF02K	Shiver 750 / ABS (10 > 16)
BF02K	ETV 1000 Caponord (01 > 10)

#### BENELLI

BF02K	BN302 (15 > 18)
BF02K	BN600 (13 > 17)
BF02K	Cafè Racer 899 (10)
BF02K	TRE 899 K / TRE 11130 K (06 > 16)
BF02K	TORNADO NAKED TRE 899 (10)

BF02K TORNADO NAKED TRE 899S (10)

BF02K Cafè Racer 1130 (10)

BF02K Titanium (10)

BF02K TORNADO NAKED TRE R160 (10)

#### BMW

BF31K G 310 R (17 > 18)

BF31K G 310 GS (17 > 18)

BF15K F 650 GS / F 800 GS (08 > 17)

BF19K G 650 GS (11 > 17)

BF15K F 700 GS (13 > 17)

BF11K F 750 GS (18) **NEW**

BF15K F 800 GS Adventure (13 > 18)

BF16K F 800 GT (13 > 18)

BF16K F 800 R (09 > 14)

BF16K F 800 R (15 > 18)

BF11K F 850 GS (18) **NEW**

BF22K S 1000 RR (12 > 18)

BF22K S 1000 R (14 > 18)

BF11K S 1000 XR (15 > 18)

BF11K R 1150 R (01 > 06)

BF11K R 1150 RT (01)

BF11K R 1150 RT (02 > 04)

BF11K K 1200 R (05 > 08) / K 1300 R (09 > 16)

BF11K K 1200 S (05 > 08) / K 1300 S (09 > 16)

BF11K K 1200 GT / K 1300 GT (06 > 10)

BF11K K 1200 RS (00 > 04)

BF17K R 1200 GS (04 > 12)

BF11K R 1200 GS (13 > 18)

BF22K R 1200 GS Adventure (06 > 13)

BF17K R 1200 GS Adventure (14 > 18)

BF22K R 1200 R (11 > 14)

BF11K R 1200 R (15 > 18) **NEW**

BF11K R 1200 RS (15 > 18)

BF17K R 1200 RT (14 > 18)

BF22K R 1200 S (06)

BF22K R NINE T 1200 (14 > 18)

BF11K R 1250 GS (19) **NEW**

BF22K R Nine T Scrambler (16 > 18)

#### CAGIVA

BF05K Mito 125

#### DUCATI

BF09K Monster 696 / 796 / 1100 (08 > 14)

BF08K Monster S2R / S4R / S4RS 800 / 1000 (04 > 08)

BF08K 848 / 1098 / 1198 (07 > 12)

BF08K ST2 / ST4 900 (97 > 01)



<b>BF11K</b>	Multistrada 950 (17 > 18)
<b>BF09K</b>	Monster 1100 Evo (11 > 12)
<b>BF08K</b>	Monster 1200 (14 > 18)
<b>BF11K</b>	Multistrada 1200 (10 > 12)
<b>BF11K</b>	Multistrada 1200 (13 > 14)
<b>BF11K</b>	Multistrada 1200 (15 > 18)
<b>BF11K</b>	Multistrada Enduro 1200 (16 > 18)
<b>BF11K</b>	Multistrada 1260 (18) <b>NEW</b>
<b>HONDA</b>	
<b>BF20K</b>	CB 500 F (16 > 18)
<b>BF20K</b>	CB 500 X (13 > 18)
<b>BF03K</b>	CBF 600 S/ CBF 600 N (04 > 12)
<b>BF03K</b>	CBR 600 F (11 > 13)
<b>BF03K</b>	CBR 600 RR (05 > 06)
<b>BF03K</b>	CBR 600 RR (07 > 09)
<b>BF03K</b>	Hornet 600 / Hornet 600 ABS (07 > 10)
<b>BF03K</b>	Hornet 600 (11 > 13)
<b>BF20K</b>	CB 650 F (14 > 16) / CBR 650 F (14 > 16)
<b>BF30K</b>	CB 650 F (17 > 18)
<b>BF03K</b>	NT 700 Deauville (06 > 12)
<b>BF03K</b>	XL 700 V Transalp (08 > 13)
<b>BF03K</b>	VFR 800 VTEC (02 > 11)
<b>BF20K</b>	VFR 800 F (14 > 18)
<b>BF03K</b>	CB 1000 R (08 > 17)
<b>BF38K</b>	CB 1000 R (18) <b>NEW</b>
<b>BF03K</b>	CBF 1000 / ABS (06 > 09)
<b>BF03K</b>	CBF 1000 / CBF 1000 ST (10 > 14)
<b>BF03K</b>	CBR 1000 RR (08 > 09)
<b>BF03K</b>	CBR 1000 RR (12 > 13)
<b>BF30K</b>	CBR 1000 RR (17 > 18) <b>NEW</b>
<b>BF03K</b>	Crosstourer 1200 / Crosstourer 1200 DCT (12 > 18)
<b>BF03K</b>	VFR 1200 F (10 > 16)
<b>BF03K</b>	CB 1300 S (10 > 15)
<b>KAWASAKI</b>	
<b>BF14K</b>	Ninja 300 (13 > 18)
<b>BF29K</b>	Versys-X 300 (17 > 18)
<b>BF04K</b>	ER 6N / ER 6F 650 (05 > 08)
<b>BF04K</b>	ER-6N / ER-6F 650 (09 > 11)
<b>BF04K</b>	ER-6N / ER-6F 650 (12 > 16)
<b>BF04K</b>	ZX-6R (09 > 12)
<b>BF04K</b>	Versys 650 (10 > 14)
<b>BF28K</b>	Z 650 (17 > 18)
<b>BF04K</b>	Z 750 (03 > 06)
<b>BF04K</b>	Z 750 (07 > 14)
<b>BF04K</b>	Z800 (13 > 17)
<b>BF29K</b>	Z 900 (17 > 18)
<b>BF04K</b>	Z 900 RS (18) <b>NEW</b>
<b>BF04K</b>	Versys 1000 (12 > 14)
<b>BF04K</b>	Versys 1000 (15 > 16)

<b>BF04K</b>	Versys 1000 (17 > 18)
<b>BF04K</b>	Z 1000 (10 > 13)
<b>BF32K</b>	Z 1000 (14 > 18)
<b>BF04K</b>	Z 1000 SX (11 > 16)
<b>BF04K</b>	Z 1000 SX (17 > 18)
<b>BF35K</b>	Ninja H2 SX (18) <b>NEW</b>
<b>BF04K</b>	ZX 10 R (10 > 12)
<b>KTM</b>	
<b>BF12K</b>	DUKE 125-200-390 (11 > 16)
<b>BF33K</b>	Duke 125-390 (17 > 18)
<b>BF37K</b>	Duke 790 (18) <b>NEW</b>
<b>BF02K</b>	Superduke 990 (08)
<b>BF11K</b>	1050 Adventure (15 > 16) / 1090 Adventure (17 > 18)
<b>BF11K</b>	1190 Adventure / 1190 Adventure R (13 > 16)
<b>BF11K</b>	1290 Superduke (13 > 18)
<b>BF11K</b>	1290 Super Adventure (15 > 16) / 1290 Super Adventure T (17)
<b>BF11K</b>	1290 Super Adventure R (17 > 18) <b>NEW</b>
<b>BF11K</b>	1290 Super Adventure S (17 > 18) <b>NEW</b>
<b>MV AGUSTA</b>	
<b>BF02K</b>	Agusta Brutale 675-800 (13 > 15)
<b>BF05K</b>	Agusta Brutale 750-910
<b>BF02K</b>	Turismo Veloce 800 (15)
<b>BF02K</b>	F3 675-800
<b>BF05K</b>	F4 750-1000
<b>ROYAL ENFIELD</b>	
<b>BF39K</b>	Himalayan (18) <b>NEW</b>
<b>SUZUKI</b>	
<b>BF01K</b>	V-Strom 250 (17 > 18)
<b>BF01K</b>	GSR 600 (06 > 11)
<b>BF01K</b>	GSX R 600 / 750 (06 > 07)
<b>BF01K</b>	GSX R 600 / 750 (08 > 10)
<b>BF10K</b>	DL 650 V-Strom (04 > 11)
<b>BF01K</b>	DL 650 V-Strom L2-L3-L4-L5-L6 (11 > 16)
<b>BF01K</b>	DL 650 V-Strom (17 > 18)
<b>BF01K</b>	Gladius 650 (09 > 16)
<b>BF01K</b>	GSF 650 BANDIT / GSF BANDIT S K9-L0-L1-L2-L3-L4 (09 > 15)
<b>BF01K</b>	GSX 650 F (08 > 14) / GSX 1250 F (10 > 16)
<b>BF01K</b>	SV 650 / SV 650 S (03 > 08)
<b>BF01K</b>	SV 650 (16 > 18)
<b>BF01K</b>	GSX S750 (17 > 18)
<b>BF01K</b>	GSR 750 (11 > 16)
<b>BF10K</b>	DL 1000 V-Strom (02 > 11)
<b>BF18K</b>	DL 1000 V-Strom (14 > 16)
<b>BF18K</b>	DL 1000 V-Strom (17 > 18)
<b>BF01K</b>	GSX R 1000 (09 > 12)

<b>BF01K</b>	SV 1000 / SV 1000 S (03 > 07)
<b>BF18K</b>	GSX S 1000 F / GSX S 1000 (15 > 18)
<b>BF01K</b>	GSX 1250 F (10)
<b>BF01K</b>	GSX 1300R Hayabusa (08 > 16)
<b>TRIUMPH</b>	
<b>BF02K</b>	Daytona 675
<b>BF02K</b>	Street Triple 675 (07 > 12)
<b>BF02K</b>	Street Triple 675 (13 > 16)
<b>BF02K</b>	Street Triple 765 (17 > 18)
<b>BF02K</b>	Tiger 800 / 800 XC / 800 XR (11 > 17)
<b>BF02K</b>	Tiger 800 XC / 800 XR (18) <b>NEW</b>
<b>BF02K</b>	ST 1050 Sprint (05 > 11)
<b>BF02K</b>	Tiger 1050 (07 > 12)
<b>BF02K</b>	Tiger Sport 1050 (13 > 18)
<b>BF02K</b>	Speed Triple 1050 (08 > 10)
<b>BF02K</b>	Speed Triple 1050 (11 > 15)
<b>BF02K</b>	Speed Triple 1050 (16 > 17)
<b>BF02K</b>	Sprint GT 1050 (10 > 16)
<b>BF02K</b>	Tiger Explorer 1200 (12 > 15)
<b>BF02K</b>	Tiger Explorer 1200 (16 > 17)
<b>BF02K</b>	Tiger 1200 (18) <b>NEW</b>
<b>YAMAHA</b>	
<b>BF05K</b>	MT-03 321 (16 > 18)
<b>BF05K</b>	FZ6/FZ6 600 Fazer (04 > 06)
<b>BF05K</b>	FZ6 S2 / FZ6 600 Fazer S2 (07 > 11)
<b>BF05K</b>	XJ6 (09 > 12) / XJ6 Diversion / XJ6 Diversion F 600 (09 > 13)
<b>BF05K</b>	XJ6 600 (13 > 15)
<b>BF05K</b>	MT-03 660 (06 > 14)
<b>BF05K</b>	YZF 600 R6 (06 > 07)
<b>BF21K</b>	MT-07 700 (14 > 17)
<b>BF36K</b>	MT-07 (18) <b>NEW</b>
<b>BF05K</b>	MT-07 Tracer (16 > 18)
<b>BF24K</b>	XSR 700 (16 > 18)
<b>BF05K</b>	FZ8 / Fazer 8 800 (10 > 15)
<b>BF05K</b>	MT-09 850 (13 > 16)
<b>BF05K</b>	MT-09 (17 > 18)
<b>BF23K</b>	MT-09 850 Tracer (15 > 17)
<b>BF05K</b>	TDM 900 (02 > 14)
<b>BF05K</b>	XSR 900 (16 > 18) <b>NEW</b>
<b>BF23K</b>	Tracer 900 / Tracer 900 GT (18) <b>NEW</b>
<b>BF05K</b>	Niken 900 (19) <b>NEW</b>
<b>BF05K</b>	FZ1 1000 (06 > 15)
<b>BF05K</b>	FZ1 1000 Fazer (06 > 15)
<b>BF05K</b>	YZF R1 1000 (09 > 12)
<b>BF27K</b>	MT-10 (16 > 18)
<b>BF05K</b>	XT 1200 Z Superteneré (10 > 18)
<b>BF05K</b>	XT 1200 ZE Superteneré (14 > 18)
<b>BF05K</b>	FJR 1300 (06 > 12)
<b>BF05K</b>	XJR 1300 (07 > 14)



→ SOFT BAGS  
ALPHA RANGE



AH200	AH201	AH202	AH203
→NEW	→NEW	→NEW	→NEW



AH208	AH209	AH213 TANKLOCK
→NEW	→NEW	→NEW

→ SOFT BAGS

■ →  
**AH200 →NEW**



**AH200**

Expandable tank bag

Features:

- Transparent map holder
- Anti-slip rubber base
- Safety strap (to be secured to the head stock)
- Removable straps for carrying as a rucksack
- Rain cover
- Reflective prints
- Handle for transport by hand
- Side pockets with zip

Mounting kit: magnets / adjustable straps for non metallic fuel tanks

**TECH INFO**





→ **AH201** →NEW

**AH201**

Double tank bag.

Features:

- Consisting of two expandable, detachable sections
  - Transparent map holder
  - Anti-slip rubber base
  - Safety strap (to be secured to the head stock)
  - Rain cover
  - Reflective prints
  - Removable straps for carrying as a rucksack
- Mounting kit: magnets / adjustable straps for non metallic fuel tanks

**TECH INFO**



→ SOFT BAGS



→ **AH202** →NEW

**AH202**

Pair of expandable side bags.

Features:

- Rain cover
- Reflective prints
- Base made from fireproof fabric
- Anti-slip / anti scratch fabric on the rear
- Extendable
- Mesh pocket
- Front pocket

Mounting kit: adjustable hook and loop fastening straps and two elasticated straps for securing the bag to the bike



**TECH INFO**



→ SOFT BAGS  
**ALPHA RANGE**



**TECH INFO**



■ → **AH203** → NEW

**AH203**

Expandable mini tail bag.

Features:

- Rain cover
- Shoulder strap
- Anti-slip base guaranteeing secure, stable mounting
- Reflective prints
- Extendable

Mounting kit: Three adjustable straps for securing the bag to either the saddle or a luggage carrier.



→ SOFT BAGS



■ → **AH208** → NEW

**AH208**

Motorcycle handlebar bag.

Features:

- Rain cover
- Ability to be converted into a waist bag using the straps supplied
- Reflective prints

Belt kit with sliding closure for an adjustable fit



**TECH INFO**





■ → **AH209** → NEW

**AH209**

Leg bag.

Features:

- Adjustable thigh strap
- Front pocket
- Internal mobile phone compartment



**TECH INFO**



■ → **AH213 TANKLOCK** → NEW

**AH213**

Tank bag with TANKLOCK system.

Features:

- Transparent map holder
- Rain cover
- Reflective prints
- Front handle
- Central safety belt to be fixed around the handlebars

PLEASE CHECK THE "MY MOTORCYCLE" SECTION TO FIND THE FLANGE COMPATIBLE WITH YOUR SPECIFIC MODEL OF MOTORCYCLE.



**TECH INFO**



**SPECIFIC RANGE**

Consulta la sezione EQUIPAGGIAMENTI SPECIFICI PER MOTO E SCOOTER per verificare l'esistenza dell'articolo specifico per la tua moto

KAPPA

→ SOFT BAGS  
LIGHT RANGE



LH200 - TANK BAG



LH201



LH203R



LH208



LH210YL



LH210OR



LH211

→ SOFT BAGS



## LH201

LH201 ↘ Expandable tank bag

Features:

- Consisting of two expandable, detachable sections
- Transparent map holder
- Anti-slip rubber base
- Safety strap (to be secured to the head stock)
- Rain cover
- Reflective inserts

Material: Polyester with finishes made from reflective fabric  
 Mounting kit: magnets / adjustable straps for non metallic fuel tanks

### TECH INFO



### SPARE PARTS

TK724A ↘ Adjustable fastening belts

TK712R ↘ Rain cover



## LH203R

LH203R ↘ Expandable mini tail bag created specifically for use with Enduro bikes

Features:

- Internal storage bag for tools etc
- Rain cover
- Shoulder strap
- Anti-slip base guaranteeing secure, stable mounting

Material: Polyester with inserts made from silver reflective fabric  
 Mounting kit: Three adjustable straps for securing the bag to either the saddle or a luggage carrier

### TECH INFO



→ SOFT BAGS  
**LIGHT RANGE**



**TECH INFO**

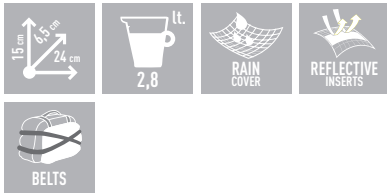

■ →  
**LH208**

**LH208** ↘

Motorcycle handlebar bag

Features:

- Rain cover
- Ability to be converted into a waist bag using the straps supplied

Material: Polyester with inserts made from silver reflective fabric  
 Mounting kit: adjustable straps with hook and loop fastening



■ →  
**LH210YL**

**LH210YL** ↘

Backpack

Features:

- Reflective logo
- Expandable with zips
- Rain cover
- Padded shoulder straps
- Front handle
- Reflective inserts on sides and shoulder straps
- Padded back for greater comfort
- Inside pockets

Materials: 420D Polyester PVC  
 Colour: black / yellow



**TECH INFO**







## LH2100R

LH2100R ↘ Backpack

Features:

- Reflective logo
- Expandable with zips
- Rain cover
- Padded shoulder straps
- Front handle
- Reflective inserts on sides and shoulder straps
- Padded back for greater comfort
- Inside pockets

Materials: 420D Polyester PVC  
Colour: black / orange

### TECH INFO



## LH211

LH211 ↘ Waist bag

Features:

- Reflective logo
- Zip opening
- External pocket on the back
- Adjustable straps with hooks
- Internal net pocket

Materials: 420D Polyester PVC



### TECH INFO



→ SOFT BAGS  
**DRY PACK RANGE**



WA401S

WA402S

WA404R

WA405F

→NEW



WA406S

WA407S

WA408S



■ → **WA401S**

**WA401S**

Saddle roll bag (it can be used on a rack if it is enough wide to support it safely) equipped with great loading capacity.

Features:  
 • "Roll top" closing system.

Material: Tarpaulin, sealed with the Seamless Technology (sealed with high frequency).  
 Mounting kit: elastic in equipment, universal fitting system, equipped with shoulder belt.

All materials are developed in accordance with Reach regulations.

**TECH INFO**





## WA402S

### WA402S

Waterproof rucksack the main compartment part is "welded" to a solid shoulder strap equipped with waste buckle.

#### Features:

- Removable helmet bag and
- Removable padding for the back lumbar protection
- "Roll top" closing system.

Material: Tarpaulin, sealed with the Seamless Technology (sealed with high frequency)

All materials are developed in accordance with Reach regulations.

#### TECH INFO



## WA404R →NEW

### WA404R

Waterproof tail bag that can be secured to the pillion seat of a motorcycle, maxiscooter or quad and can easily be transformed into a multi-purpose bag.

#### Features:

- Handles and shoulder strap
- "Roll top" closure system

Material: Tarpaulin, sealed with high frequency Seamless Technology

Mounting kit: universal fitting system using elasticated straps supplied

All materials are developed and produced in accordance with Reach regulations.

#### TECH INFO



→ SOFT BAGS  
**DRY PACK RANGE**



■ →  
**WA405F**

**WA405F**

Saddle roll bag (it can be used on a rack if it is enough wide to support it safely) equipped with great loading capacity.

- "Roll top" closing system.

Material: Tarpaulin, sealed with the Seamless Technology (sealed with high frequency).  
 Mounting kit: elastic in equipment, universal fitting system, equipped with shoulder belt.

All materials are developed in accordance with Reach regulations.



**TECH INFO**

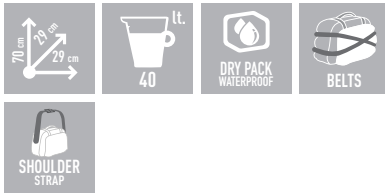

■ →  
**WA406S**

**WA406S**

Waterproof cargo-bag that can be mounted to the lid of the K-Venture side-case using standard elasticated straps equipped with 4 double "D" rings. Universal fitting system. "Roll top" closure system. Includes shoulder strap for easy transportation.

Material: Tarpaulin, sealed with high frequency Seamless Technology.  
 Mounting kit: universal fitting system using elasticated straps supplied.

All materials are developed and produced in accordance with Reach regulations.



**TECH INFO**

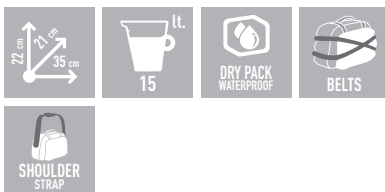



#### TECH INFO

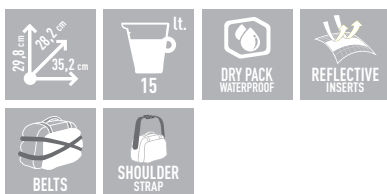

## WA407S

**WA407S** ↘ Scooter tunnel bag

#### Features:

- Carrying handle
- Reflective inserts
- Mounting straps for securing to a motorbike/rack or side-case
- Shoulder strap
- Anti-slip base and front pocket with zip (not 100% waterproof)
- "Roll top" closure system

Material: Tarpaulin, sealed with high frequency Seamless Technology.

Mounting kit: universal fitting system using elasticated straps supplied.

All materials are developed and produced in accordance with Reach Regulations.



#### TECH INFO

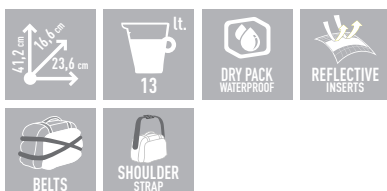

## WA408S

**WA408S** Rucksack.

#### Features:

- Carrying handle
- Reflective inserts
- Mounting straps for securing to a motorbike/rack or side-case
- Shoulder strap
- Anti-slip base and front pocket with zip (not 100% waterproof)
- "Roll top" closure system

Material: Tarpaulin, sealed with high frequency Seamless Technology.

Mounting kit: universal fitting system using elasticated straps supplied.

All materials are developed and produced in accordance with Reach Regulations.



→ SOFT BAGS  
CAFÈ RACER RANGE



CR600

CR601U

CR602

→NEW

→NEW

→ SOFT BAGS



→  
**CR600**

CR600

Tank bag

Characteristics:

- Transparent tablet holder with rapid fixing with the use of belts with straps
- Polypropylene internal reinforcement
- Shoulder strap for transportation
- Front handle
- Internal lining with sealed seams to guarantee the bag is waterproof
- Metal accessories

Mounting kit: 4 magnets

Materials: High UV resistance polyester – "eco-leather"

TECH INFO





## CR601U

**CR601U** Side bag

**Characteristics:**

- Single side bag with rapid attach/release system for TMT side frame fitting kits. Also equipped with a belt fastening system for use with TE, PL and PLR side frame fitting kits. (When fitted to PL and PLR side frames, it is necessary to remove the nose unit and valve stems)
- Polypropylene internal reinforcement
- Padded shoulder strap for easy carrying
- Handle to enable carrying by hand
- Internal lining with sealed seams to guarantee the bag is waterproof
- Metal accessories

Materials: High UV resistance polyester – eco-leather

**TECH INFO**



### SPECIFIC RANGE

**CR601U:** check the TMT compatible with the model of your bike in "YOUR MOTORBIKE" page



**YAMAHA**  
XSR 700 (16 → 18)  
**TMT2126**



**YAMAHA**  
XSR 900 (16 → 18)  
**TMT2128**



**TRIUMPH**  
Street Twin 900 (16 → 18)  
**TMT6407**



**TRIUMPH**  
Bonneville T120 (16 → 18)  
**TMT6410**



**BMW**  
R NINE T 1200 (14 → 18)  
**TMT5115**

## CR602

**CR602** Saddle bag

**Characteristics:**

- Saddle bag attached with elastic straps
- Polypropylene internal reinforcement
- Padded shoulder strap for easy carrying
- Handle to enable carrying by hand
- Internal lining with sealed seams to guarantee the bag is waterproof
- Metal accessories

Materials: High UV resistance polyester – "eco-leather"



**TECH INFO**



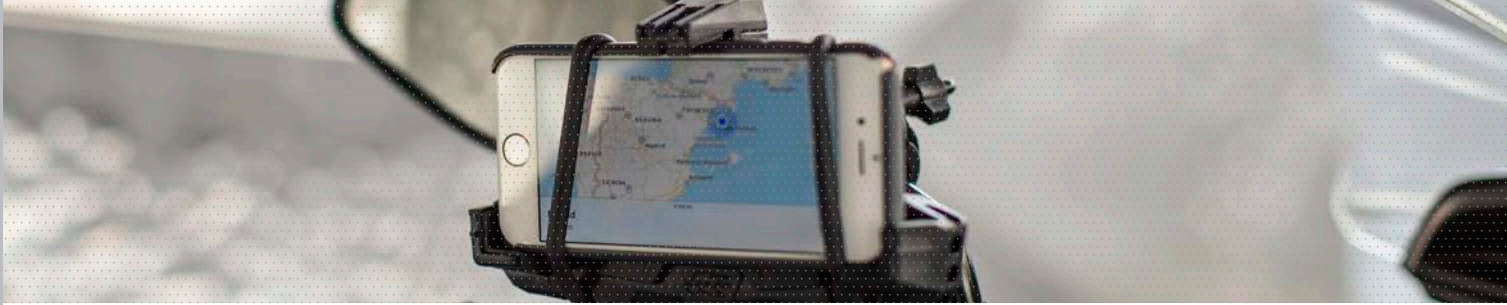

→ ACCESSORIES  
**UNIVERSAL ACCESSORIES**



■ →  
**TK4KIT**

**TK4KIT**

Magnets kit (including 4 magnets to allow the mounting on metallic tanks)



■ →  
**KS201**

**KS201L**  
**KS201XL**

Motorcycle cover  
Motorcycle cover



■ →  
**KS210**

**KS210**

Waterproof saddle cover



■ →  
**KS603**

**KS603**

Pair of hands protector for motorcycles and scooters

**19,10**





■ →

## KS601

KS601\*

Holder designed for the motorway toll paying device "TELEPASS"\*. Complete with universal fitting kit, suitable for motorcycle models with round handlebar

\*\*TELEPASS IS A REGISTERED TRADEMARK BELONGING TO ATLANTIA AND AUSTOSTRADE OF ITALY. / ALL TRADEMARKS, NAMES AND PDA MODELS ARE PROPERTY OF THE RESPECTIVE COMPANIES



■ →

## KS602

KS602\*

Waterproof, removable holder designed for the motorway toll paying device "TELEPASS"\*. It is attached to a motorcycle using adhesive tabs.

\*\*TELEPASS IS A REGISTERED TRADEMARK BELONGING TO ATLANTIA AND AUSTOSTRADE OF ITALY. / ALL TRADEMARKS, NAMES AND PDA MODELS ARE PROPERTY OF THE RESPECTIVE COMPANIES

Z1325MK

Adhesive tap for the fitting of the motorway toll paying device holder KS602 on the motorcycle (complete with biadhesive)



■ →

## KS961

KS961

Electronic device holder for the motorway toll



■ →

## KS650

KS650

Child's chair  
BEFORE USE, VERIFY THE COUNTRY LEGISLATION REGARDING PILLION PASSENGERS AND ROAD SAFETY

S650KITK\*

Kit with long brackets for KS650 Child's chair



■ →  
**TK25**

TK25 Anti-slip net /paint protection for side soft luggage

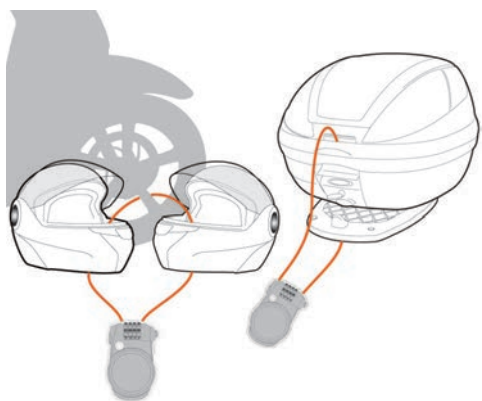

■ →  
**KS220 COMBINATION CABLE LOCK**

KS220 Padlock with retractable wire and combination lock



■ →  
**K9910N**

K9910N Elastic carrying net  
BLACK COLOUR

■ →  
**E125K**

E125K\* Kit of 4 rings for the fitting of the elastic net K9910.  
\*IN ORDER TO FIT THEM YOU MUST DRILL FOUR HOLES OF Ø 10MM



■ →  
**E161K**

E161K Inner elastic carrying net



■ →

## E162

E162K

Support in stainless steel for thermal flask.  
Compatible with KVE58 / KVE42 / KVE37 and KGR33 / KGR46



■ →

## KS350 ADVENTURE STRAPS

KS350

Pair of Adventure Straps belts, maximum traction load 100 kg.



■ →

## EX1SRAK-BAG HOLDER

EX1SRAK

Expandable aluminium bag holder to fit on the aluminium rear supports KRA\_ \_.



■ →

## KS450 - TUBELESS TYRES REPAIR KIT

KS450

Tubeless tyres repair kit

■ →

## KS450KIT

KS450KIT

Set of three CO2 cans for the Tubeless Tyres Repair Kit [KS450].  
**PACKED IN A BAG WITH CARDBOARD WITH GRAPHICS AND A HOLE FOR HANGING / DISPLAYING.**



■ →  
**KS150**

**KS150**

Universal Nylon Rack with fixing system with half-spheres to fit the feet to the different top-cases round shapes



■ →  
**KS410**

**KS410**

Universal Trolley Base for MONOKEY® top-cases. To be combined with a MONOKEY® fitting plate. Security Lock system  
**IT CAN BE ATTACHED TO ALL MONOKEY® PLATES TO CONVERT A MONOKEY® TOP-CASE INTO A PRATICAL TROLLEY CASE. (COMPATIBLE WITH ALL MODELS OF MONOKEY® TOP-CASES)**

■ →  
**KS250 - TOOL BOX**

**KS250**

Tool box to be installed between the side-case holder and motorcycle fairing. TO BE COMBINED WITH THE UNIVERSAL FIXING KIT KS250KIT OR WITH SPECIFIC FIXING KITS KTL



**Z9189KR**  
**Z9186RK**  
**Z726RK**  
**Z9191RK**

Assembled top-shell  
Assembled bottom-shell  
Lock lining  
Internal removable divider



**SPECIFIC RANGE**

Consult the section "MY MOTORCYCLE" to verify the compatibility of products for your motorcycle

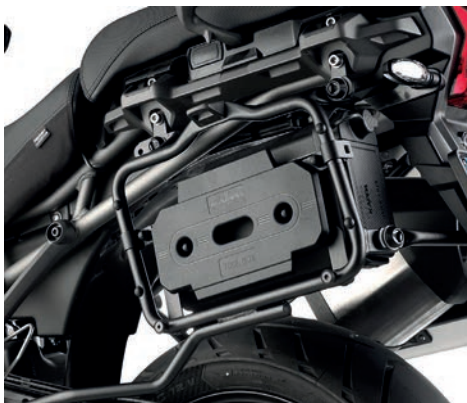

■ →  
**KS250KIT**

**KS250KIT\***

Universal kit to install the KS250 Tool Box on specific pannier holder KL, KLR  
**\*TO BE COMBINED WITH KS250 AND THE SPECIFIC PANNIER HOLDER**



**SPECIFIC RANGE**

Consult the section "MY MOTORCYCLE" to verify the compatibility of products for your motorcycle



■ →  
**STTR40K**

**STTR40K**

Universal support to mount either the GPS Tom Tom Rider (40, 400, 410, II, 42, 420, 450, 500, 550) on tubular handlebars or on the stalk of a rearview mirror  
**COMPATIBLE WITH TUBULAR HANDLEBARS WITH A DIAMETER OF 8 TO 35 MM**

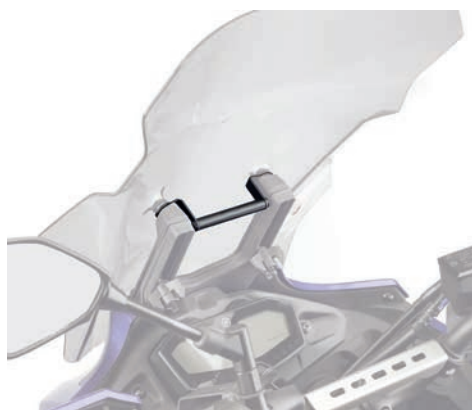

■ →  
**KFB**

**KFB\_-----**

Fairing upper bracket to be mounted behind the windshield to install KS920M, KS920L and GPS-Smartphone holder  
**FOR KS920M, KS920L, KS952B, KS953B, KS954B, KS955B, KS956B**





■ → **KS920M SMART CLIP**

**KS920M**

Universal smartphone holder pliers to mount on motorcycles, scooters, bicycles and quads. For devices with external dimensions from 112 x 52mm to 148 x 75mm. [Click on the link to download a list of devices that can be accommodated in the KS920M](https://media.kappamoto.com/AK-Prodotti/pdf/KS920M_comp.pdf)



■ → **KS920L SMART CLIP**

**KS920L**

Universal smartphone holder pliers to mount on motorcycles, scooters, bicycles and quads. For devices with external dimensions from 144 x 67mm to 178 x 90mm. [Click on the link to download a list of devices that can be accommodated in the KS920L](https://media.kappamoto.com/AK-Prodotti/pdf/KS920L_comp.pdf)



■ → **KS952B / KS953B / KS954B**

**KS952B\***

Smart phone / GPS holder for handlebar mounting suitable for screens up to 3.5 inches. Compatible with scooter, bike and bicycle.  
**INNER DIMENSIONS (MM): 125X84 (SUNSHADE ON THE LONG SIDE). WINDOW SIZE (MM): 104X67**

**KS953B\***

Smart phone / GPS holder for handlebar mounting suitable for screens up to 4.3 inches. Compatible with scooter, bike and bicycle.  
**\*INNER DIMENSIONS (MM): 139X90 (SUNSHADE ON THE LONG SIDE). WINDOW SIZE (MM): 112X67**

**KS954B**

Smart phone / GPS holder for handlebar mounting suitable for screens up to 5 inches. Compatible with scooter, bike and bicycle.  
**INNER DIMENSIONS (MM): 158X102 (SUNSHADE ON THE LONG SIDE). WINDOW SIZE (MM): 137X86**

**ZS952RCK**

Rain cover for GPS - smartphone holder: KS952-KS952B

**ZS953RCK**

Rain cover for GPS - smartphone holder: KS953-KS953B

**ZS954RCK**

Rain cover for GPS - smartphone holder: KS954-KS954B



## KS955B

**KS955B** Smartphone holder for handlebar mounting. Compatible with scooter, bike and bicycle.  
**INNER DIMENSIONS (MM): 67X130 (SUNSHADE ON THE SHORT SIDE). WINDOW SIZE (MM): 58X124**

**ZS955RCK** Rain cover for smartphone holder: KS955-KS955B



## KS956B

**KS956B** Universal Smartphone holder. Compatible with scooter, bike and bicycle.

**ZS956RCK** Rain cover for smartphone holder: KS956B



## KS957B

**KS957B\*** Universal Smartphone holder. Compatible with scooter, bike and bicycle.

**ZS957RCK** Rain cover for smartphone holder: KS957B



## → UNIVERSAL FITTING SYSTEM FOR SMARTPHONE / GPS HOLDERS

Thanks to the mounting system to attach and remove the smartphone holder is extremely simple and fast, taking only a matter of seconds. Loosening the handle on the mounting support can adjust the position of the smartphone holder according to the rider's specific requirements, at any time and without the need for any tools.

The shell has shock-absorbing inserts to protect the device being held. The product is also supplied with a safety strap, sunshade, touch-sensitive front surface, a power supply port and a waterproof cover to be used in the event of heavy rain.

- **QUICK FIXING:** Reinforced system compatible with the previous and current models of KAPPA device holders
- **ADJUSTABLE:** A locking nut provides adjustable tilt and rotation
- **SAFE AND UNIVERSAL:** Rubber parts ensure a firm grip on structures with sections of any configuration
- **EASY INSTALLATION:** Quick mounting without tools



SCOOTER



BIKES



BICYCLES

→ MOTORCYCLE ACCESSORIES  
ACCESSORIES



■ →  
**KS900A**

**KS900A**

Universal aluminium handle bar to install GPS holders, smartphone holders, electronic device holders for road use.

■ →  
**0\_SKIT**

**01SKITK**

Specific kit to mounting the KS900A Smart Bar

**02SKITK**

Specific kit to mounting the KS900A Smart Bar

**03SKITK**

Specific kit to mounting the KS900A Smart Bar

**04SKITK**

Specific kit to mounting the KS900A Smart Bar

**05SKITK**

Specific kit to mounting the KS900A Smart Bar

**06SKITK**

Specific kit to mounting the KS900A Smart Bar



**SPECIFIC RANGE**

Consult the section "MY MOTORCYCLE" in order to check the range of specific products available for your vehicle

**APRILIA**

**01SKITK** Shiver 750 / Shiver GT 750 (07 > 12) / ABS (09 > 12)

**01SKITK** Shiver 750 / ABS (10 > 16)

**01SKITK** Dorsoduro 750 / Dorsoduro 1200 (08 > 16)

**01SKITK** Mana 850 / Mana 850 GT (08 > 16)

**01SKITK** Tuono V4 R (11 > 14)

**01SKITK** Caponord 1200 (13 > 17)

**BENELLI**

**03SKITK** BN302 (15 > 18)

**05SKITK** TRK502 (17 > 18)

**03SKITK** BN600 (13 > 17)

**BMW**

**05SKITK** G 310 R (17 > 18)

**05SKITK** G 310 GS (17 > 18)

**01SKITK** F 650 GS / F 800 GS (08 > 17)

**01SKITK** G 650 GS (11 > 17)

**01SKITK** F 700 GS (13 > 17)

**01SKITK** F 750 GS (18) **NEW**

**01SKITK** F 800 GS Adventure (13 > 18)

**01SKITK** F 800 GT (13 > 18)

**01SKITK** F 800 R (09 > 14)

**05SKITK** F 800 R (15 > 18)

**01SKITK** F 850 GS (18) **NEW**

**01SKITK** S 1000 XR (15 > 18)

**01SKITK** R 1200 GS (04 > 12)

**01SKITK** R 1200 GS (13 > 18)

**01SKITK** R 1200 GS Adventure (06 > 13)

**01SKITK** R 1200 GS Adventure (14 > 18)

**04SKITK** R 1200 R (11 > 14)

**01SKITK** R 1200 R (15 > 18) **NEW**

**01SKITK** R 1200 RS (15 > 18)

**04SKITK** R 1200 RT (05 > 13)

**01SKITK** R NINE T 1200 (14 > 18)

**01SKITK** R 1250 GS (19) **NEW**

**01SKITK** R Nine T Scrambler (16 > 18)

**DUCATI**

**05SKITK** Monster 696 / 796 / 1100 (08 > 14)

**03SKITK** Hypermotard 796 / 1100 (12 > 14)

**03SKITK** Monster S2R / S4R / S4RS 800 / 1000 (04 > 08)

**03SKITK** Hyperstrada 821 (13 > 16)

**04SKITK** Streetfighter 848 / 1098 (09 > 15)

**03SKITK** Hypermotard 939 (16 > 18)

**03SKITK** Hyperstrada 939 (16)

**04SKITK** Multistrada 950 (17 > 18)

**05SKITK** Monster 1200 (14 > 18)

**04SKITK** Multistrada 1200 (15 > 18)

**04SKITK** Multistrada Enduro 1200 (16 > 18)

**HONDA**

**01SKITK** CB 125 R (18 > 19) **NEW**

**03SKITK** XL 125 V Varadero (01 > 06)

**03SKITK** XL 125 V Varadero (07 > 14)

**02SKITK** CB 500 F (13 > 15)

**02SKITK** CB 500 F (16 > 18)

**02SKITK** CB 500 X (13 > 18)

**01SKITK** CBF 600 S/ CBF 600 N (04 > 12)

**02SKITK** Hornet 600 / Hornet 600 ABS (07 > 10)

**02SKITK** Hornet 600 (11 > 13)

**02SKITK** CB 650 F (14 > 16) / CBR 650 F (14 > 16)

**02SKITK** CB 650F (17 > 18)

**01SKITK** CTX 700 DCT (14 > 16)



<b>01SKITK</b>	CTX 700 N DCT (14 > 16)
<b>02SKITK</b>	NC 700 S (12 > 13) / NC 750 S / NC 750 S DCT (14 > 15)
<b>02SKITK</b>	NC 700 X (12 > 13) / NC 750 X / NC 750 X DCT (14 > 15)
<b>03SKITK</b>	XL 700 V Transalp (08 > 13)
<b>02SKITK</b>	Africa Twin 750 (93 > 95)
<b>02SKITK</b>	NC 750 X (16 > 18)
<b>02SKITK</b>	NC 750 S (16 > 18)
<b>03SKITK</b>	Crossrunner 800 (15 > 18)
<b>01SKITK</b>	VFR 800 F (14 > 18)
<b>04SKITK</b>	CB 1000 R (08 > 17)
<b>01SKITK</b>	CB 1000 R (18) <b>NEW</b>
<b>02SKITK</b>	CBF 1000 / CBF 1000 ST (10 > 14)
<b>03SKITK</b>	CRF1000L Africa Twin (16 > 17)
<b>03SKITK</b>	CRF1000L Africa Twin (18) <b>NEW</b>
<b>03SKITK</b>	CRF1000L Africa Twin Adventure Sports (18) <b>NEW</b>
<b>01SKITK</b>	CB 1100 (13 > 14)
<b>03SKITK</b>	Crosstourer 1200 / Crosstourer 1200 DCT (12 > 18)
<b>01SKITK</b>	CTX 1300 (14 > 16)

## KAWASAKI

<b>05SKITK</b>	Z 300 (15 > 16)
<b>02SKITK</b>	Versys-X 300 (17 > 18)
<b>05SKITK</b>	KLE 500 (91 > 93)
<b>05SKITK</b>	KLE 500 (94 > 04)
<b>03SKITK</b>	ER-6N / ER-6F 650 (09 > 11)
<b>03SKITK</b>	ER-6N / ER-6F 650 (12 > 16)
<b>03SKITK</b>	Versys 650 (06 > 09)
<b>03SKITK</b>	Versys 650 (10 > 14)
<b>05SKITK</b>	Versys 650 (15 > 18)
<b>05SKITK</b>	Z 750 (03 > 06)
<b>05SKITK</b>	Z 750 (07 > 14)
<b>05SKITK</b>	Z 750 S (05 > 07)
<b>02SKITK</b>	W 800 (11 > 17)
<b>02SKITK</b>	Z800 (13 > 17)
<b>05SKITK</b>	Z 900 RS (18) <b>NEW</b>
<b>02SKITK</b>	Versys 1000 (12 > 14)
<b>05SKITK</b>	Versys 1000 (15 > 16)
<b>05SKITK</b>	Versys 1000 (17 > 18)

## KTM

<b>03SKITK</b>	DUKE 125-200-390 (11 > 16)
<b>05SKITK</b>	Duke 125-390 (17 > 18)
<b>01SKITK</b>	DUKE 690 (12 > 18)
<b>05SKITK</b>	Duke 790 (18) <b>NEW</b>
<b>01SKITK</b>	Adventure 950 / 990 (03 > 14)
<b>01SKITK</b>	Superduke 990 (08)
<b>01SKITK</b>	990 SMT (09 > 16)
<b>05SKITK</b>	1050 Adventure (15 > 16) / 1090 Adventure (17 > 18)
<b>01SKITK</b>	1190 Adventure / 1190 Adventure R (13 > 16)
<b>05SKITK</b>	1290 Super Adventure (15 > 16) / 1290 Super Adventure T (17)
<b>05SKITK</b>	1290 Super Adventure R (17 > 18) <b>NEW</b>
<b>05SKITK</b>	1290 Super Adventure S (17 > 18) <b>NEW</b>

## MASH

**02SKITK** Seventy Five 125 (14 > 18)

## MOTO GUZZI

**01SKITK** Stelvio 1200 (08 > 16)

**03SKITK** V9 Roamer / V9 Bobber (16 > 18)

## SUZUKI

**05SKITK** DL 650 V-Strom (04 > 11)

**05SKITK** DL 650 V-Strom L2-L3-L4-L5-L6 (11 > 16)

**05SKITK** DL 650 V-Strom (17 > 18)

**05SKITK** Gladius 650 (09 > 16)

**05SKITK** GSF 650 Bandit / Bandit S / Bandit ABS (05 > 06)

**05SKITK** GSF 650 BANDIT / GSF BANDIT S K9-L0-L1-L2-L3-L4 (09 > 15)

**05SKITK** GSX 650 F (08 > 14) / GSX 1250 F (10 > 16)

**05SKITK** SV 650 (16 > 18)

**03SKITK** GSX S750 (17 > 18)

**05SKITK** GSR 750 (11 > 16)

**02SKITK** DL 1000 V-Strom (14 > 16)

**02SKITK** DL 1000 V-Strom (17 > 18)

**05SKITK** GSX S 1000 F / GSX S 1000 (15 > 18)

**05SKITK** GSF 1250 Bandit / Bandit S (07 > 11)

## TRIUMPH

**05SKITK** Street Triple 765 (17 > 18)

**01SKITK** Tiger 800 / 800 XC / 800 XR (11 > 17)

**01SKITK** Tiger 800 XC / 800 XR (18) **NEW**

**05SKITK** Street Twin 900 (16 > 18)

**05SKITK** Street Scrambler 900 (17 > 18)

**01SKITK** Tiger Sport 1050 (13 > 18)

**04SKITK** Speed Triple 1050 (11 > 15)

**01SKITK** Speed Triple 1050 (16 > 17)

**01SKITK** Tiger Explorer 1200 (12 > 15)

## YAMAHA

**05SKITK** WR250R 250 (08 > 13)

**05SKITK** MT-03 321 (16 > 18)

**01SKITK** FZ6 S2 / FZ6 600 Fazer S2 (07 > 11)

**05SKITK** XJ6 (09 > 12) / XJ6 Diversion / XJ6 Diversion F 600 (09 > 13)

**05SKITK** XJ6 600 (13 > 15)

**06SKITK** MT-07 Tracer (16 > 18)

**05SKITK** FZ8 / Fazer 8 800 (10 > 15)

**01SKITK** MT-09 850 (13 > 16)

**01SKITK** MT-09 (17 > 18)

**04SKITK** MT-09 850 Tracer (15 > 17)

**05SKITK** TDM 900 (02 > 14)

**01SKITK** XSR 900 (16 > 18) **NEW**

**04SKITK** Tracer 900 / Tracer 900 GT (18) **NEW**

**05SKITK** FZ1 1000 (06 > 15)

**01SKITK** MT-10 (16 > 18)

**01SKITK** XT 1200 ZE Superteneré (14 > 18)

**05SKITK** XJR 1300 (07 > 14)

## ZERO MOTORCYCLES

**05SKITK** Zero DS (18) **NEW**

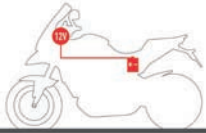

## → KS110 - POWER SOCKET

**KS110**

12V Handlebar electrical outlet socket  
**TO BE COMBINED WITH THE S111 POWER HUB OR WITH THE S112 POWER CONNECTION**

## → KS111 - POWER HUB

**KS111\***

Hub kit for the electrical feed for the tank bags  
**\*TO BE SPECIFICALLY COMBINED WITH THE KS110 KIT**

## → KS112 - POWER CONNECTION

**KS112\***

Power Connection kit for the electrical feed to devices fitted directly on the handlebar. Cable complete with a transformer which permits the direct connection with the devices. To be specifically combined with the KS110 Kit  
Comprehensive kit of 4 adapters:  
1) Micro USB socket, compatible with most Android Smartphones.  
2) Mini USB socket, compatible with most cameras and camcorders.  
3) Apple Dock connection, compatible with: iPhone 3, 4; iPad 1, 2, 3, 4; iPod Classic; iPod Nano 1, 2, 3, 4, 5, 6; iPod Shuffle 1, 2, 3, 4.  
4) Apple Lightning compatible with: iPhone 5, 5c, 5s, 6, 7, 7 Plus, 8, 8 Plus, XR, XS e XS, iPod Touch 5G, iPad4 e iPod Nano 7G.  
**\*TO BE SPECIFICALLY COMBINED WITH THE KS110 KIT COMPREHENSIVE KIT OF 4 PIN ADAPTERS (MICRO USB, MINI USB, APPLE DOCK AND APPLE LIGHTNING).**





■ →

## KS310

LS\_ \_ \_ \_ K      Specific fitting kit to mount KS310 or KS322 spotlights



■ →

## KS322

**KS322**      Pair of universal, certified anti-fog projectors, with LED technology and natural aluminium housing  
**EASILY ATTACHED TO ALL ENGINE-GUARDS WITH A TUBULAR DIAMETER OF BETWEEN 21MM AND 25MM**



■ →

## KS310

**KS310**      Pair of universal additional spotlights with halogen lights  
**EASILY ATTACHED TO ALL ENGINE-GUARDS WITH A TUBULAR DIAMETER OF BETWEEN 21MM AND 25MM**

**Z2256K**      Pair of halogen bulbs replacement 12V 55W H3 for spotlights KS310



■ →

## KS28\_

**KS280**      Pair of stainless steel universal manifold protectors. Suitable for motorcycles with manifold diameters between 32 mm and 42 mm.

**KS281**      Pair of stainless steel universal manifold protectors. Suitable for motorcycles with manifold diameters between 42 mm and 52 mm.

**KS282**      Pair of stainless steel universal manifold protectors. Suitable for motorcycles with manifold diameters between 52 mm and 60 mm.

→ MOTORCYCLE ACCESSORIES  
**ACCESSORIES**



■ → **KS290**

**KS290S**

Universal anodised aluminium heat guard, size S (length 150mm)  
**TO BE COMBINED WITH CLAMP\_\_ STEEL BANDS KIT**

**KS290M**

Universal anodised aluminium heat guard, size M (length 200mm)  
**TO BE COMBINED WITH CLAMP\_\_ STEEL BANDS KIT**

■ → **CLAMP\_\_**

**CLAMP100K**

316 stainless steel band kit, to mount the KS290S or the KS290M heat guards onto exhausts with a diameter between 80mm and 100mm  
**TO BE MOUNTED IN CONJUNCTION WITH THE KS290S OR KS290M HEAT GUARDS**

**CLAMP120K**

316 stainless steel band kit, to mount the KS290S or the KS290M heat guards onto exhausts with a diameter between 100mm and 120mm  
**TO BE MOUNTED IN CONJUNCTION WITH THE KS290S OR KS290M HEAT GUARDS**

**CLAMP140K**

316 stainless steel band kit, to mount the KS290S or the KS290M heat guards onto exhausts with a diameter between 120mm and 140mm  
**TO BE MOUNTED IN CONJUNCTION WITH THE KS290S OR KS290M HEAT GUARDS**

**CLAMP160K**

316 stainless steel band kit, to mount the KS290S or the KS290M heat guards onto exhausts with a diameter between 140mm and 160mm  
**TO BE MOUNTED IN CONJUNCTION WITH THE KS290S OR KS290M HEAT GUARDS**

→ ACCESSORIES



■ → **KRM01**

**KRM01**

Universal spray guard



**SPECIFIC RANGE**

Consult the section "MY MOTORCYCLE" in order to check the range of specific products available for your vehicle



■ → **KRM02**

**KRM02**

Universal spray guard



**SPECIFIC RANGE**

Consult the section "MY MOTORCYCLE" in order to check the range of specific products available for your vehicle

■ →

## KS180T SCREEN SPOILER



### KS180T

Universal transparent spoiler mountable to fairings / windscreens, 12,5 x 25,0 cm (H x W)  
**WE STRONGLY RECOMMEND TO CHECK WHETHER THE ORIGINAL FITTING KIT OF THE SCREEN IS ROBUST ENOUGH TO ALLOW THE MOUNTING OF THE SCREEN SPOILER / THE ALUMINUM FITTING KIT ALLOWS THE ADJUSTMENT OF BOTH HEIGHT AND INCLINATION**

■ →

## KS180F SCREEN SPOILER



### KS180F

Universal smoked spoiler mountable to fairings / windscreens 12,5 x 25,0 cm (H x W); the aluminum fitting kit allows the adjustment of both height and inclination.  
**WE STRONGLY RECOMMEND TO CHECK WHETHER THE ORIGINAL FITTING KIT OF THE SCREEN IS ROBUST ENOUGH TO ALLOW THE MOUNTING OF THE SCREEN SPOILER**



## → ACCESSORIES

### TECHNICAL ACCESSORIES



#### → ENGINE GUARDS

Conceived with the aim to provide lateral protection of the engine, not only on trail motorcycles, but also naked and custom motorcycles as well as unfaired and semi-faired models. Should a motorcycle fall whilst located on its stand and it is equipped with an engine guard, the damage sustained by the engine would be greatly reduced. The wide range of engine guards developed and produced by KAPPA includes specific solutions for a wide variety of motorcycle models. For custom motorcycles, engine guards are available in a chromed version. The characteristics of the materials used offer excellent performance, guaranteed by KAPPA expertise.

**Consult the section "My Motorcycle" in order to check the range of specific products available for your vehicle.**

Material: metal  
Finished in black mat or chromed depending on the different motorcycle models



#### → BACKRESTS

KAPPA satisfies not only the motorcyclists' needs, but the passengers' needs too. A wide range of specific backrests made in Polyurethane foam, provides more comfort to the journey of the passenger. It can be mounted with or without the case (it depends on the model of the case). You will find some mounting examples, please view our list in order to verify the availability on other motorcycle models not illustrated in here.

**Consult the section "My Motorcycle" in order to check the range of specific products available for your vehicle.**

Holders material: metal  
Backrests material: Polyurethane foam



#### → OIL CARTER PROTECTOR

Specifically designed based on the motorcycle model, the aluminium oil carter protectors make the image of maxienduro even more "off road"; they also protect the oil carter from rocks, bumps and holes that can be found, as well as when off-road, even on less challenging roads.

**Consult the section "My Motorcycle" in order to check the range of specific products available for your vehicle.**

Material: aluminium



## MUDGUARD

Specific mudguard, black colour

Material: ABS

**Consult the section "My Motorcycle" in order to check the range of specific products available for your vehicle.**



## STAND EXTENSIONS

The purpose of the range of Base Extensions is to extend the surface area of the side stand, reducing the risk of a motorbike falling when it is parked on uneven surfaces such as; mud, sand, grass or asphalt during extremely high temperatures. Produced in anodized, milled and satin aluminium with the high support made of satin INOX 316L steel and designed with a hard technical aspect, the stand extension integrates perfectly with your motorbike

**Consult the section "My Motorcycle" in order to check the range of specific products available for your vehicle.**



## RADIATOR GUARD

Stainless steel specific radiator guard black painted

Material: Stainless steel black painted

**Consult the section "My Motorcycle" in order to check the range of specific products available for your vehicle.**



**SPECIFIC RANGE**

CONSULT THE SECTION "MY MOTORCYCLE" IN ORDER TO CHECK THE RANGE OF SPECIFIC PRODUCTS AVAILABLE FOR YOUR VEHICLE

→ MOTORCYCLE ACCESSORIES  
**SCREENS**

→ **UNIVERSAL COCKPIT SCREENS**



<b>KA200</b>	Small universal spoiler for Naked motorcycles, equipped with fitting kit. Smoked colour (W x H) 34 cm x 29,5 cm	
--------------	--	--



<b>240AK</b>	Universal screen for Naked motorcycles. Smoked colour (W x H) 36,5 cm x 33 cm	
<b>A240AK</b>	Universal fitting kit for 240AK	

→ **UNIVERSAL COCKPIT SCREENS WITH SPECIFIC FITTING KIT**



<b>140AK</b>	Universal transparent screen 35 x 41 cm (H x W)	
--------------	--	--



<b>140SK</b>	Universal smoked screen 35 x 41 cm (H x W)	
--------------	---	--

To mount this screen, it is necessary to combine it with the appropriate fitting kit (AL \_ AK), specific to your model of motorcycle.





<b>100ALK</b>	Grey anodized aluminium universal screen Race Cafe, for naked motorcycles 20,5 x 26,5 cm (H x W)	
---------------	--	--



<b>100ALBK</b>	Black anodized aluminium universal screen Race Cafe, for naked motorcycles 20,5 x 26,5 cm (H x W)	
----------------	---	--

To mount this screen, it is necessary to combine it with the appropriate fitting kit (AL \_ AK), specific to your model of motorcycle.



<b>245AK</b>	Universal screen for naked motorcycles, smoked colour (H x W) 29 cm x 33,5	
--------------	--	--



<b>245NK</b>	Universal screen for naked motorcycles, black colour (W x H) 29 cm x 33,5 cm	
--------------	--	--



<b>247NK</b>	Universal screen for naked bikes, black colour (W x H) 29 cm x 28,5 cm	
--------------	--	--

→ **UNIVERSAL CUSTOM SCREENS**



<b>23A+</b> <b>AS100A2K</b>	Universal screen, low and transparent version (H x W) 38,8 cm x 41 cm	
--------------------------------	---	--



<b>A35NK+</b> <b>AS100A2K</b>	Universal wind-screen, high and shaded bottom version (H x W) 54,9 cm x 46,8 cm	
----------------------------------	---	--

→ **UNIVERSAL WINDSCREENS | 2 JOINT POINTS**



<b>33A</b>	Universal screen with 2 points handlebar, transparent (H x W) 46 cm x 57 cm	
<b>KD40</b>	Only fitting kit	
<b>Z1694RK</b>	Internal and external brackets for KD40	

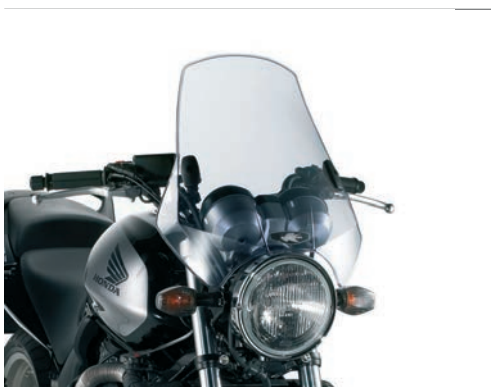

<b>KA660+</b> <b>KD40</b>	Universal screen with 2 point handlebar, smoked 42,5 x 42 cm (H x W) KD40 fitting kit included	
<b>Z1694RK</b>	Internal and external brackets for KD40	



<b>Z278K</b>	Universal adapter to fit a 2/4-fixing-points screen on motorcycle equipped with non-tubular handlebars	
--------------	--	--

## UNIVERSAL WINDSCREENS | 4 JOINT POINTS

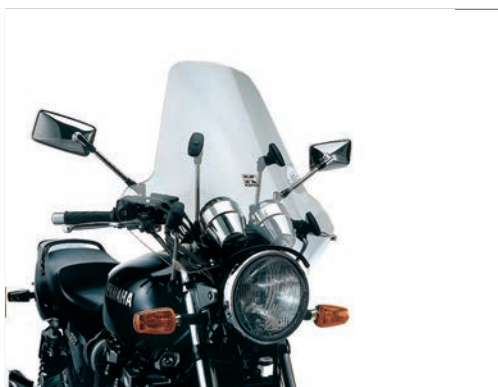

<b>620A+ KD45</b>	Universal screen with 4 point handlebar, transparent (H x W) 57 cm x 59 cm	
-----------------------	--	--



<b>A34K</b>	Universal screen with 4 point handlebar, smoked 49 x 50 cm (H x W)	
<b>KD45</b>	Only fitting kit for for universal screen with 4 point handlebar	

## UNIVERSAL WINDSCREENS | 4 JOINT POINTS - AIRSTREAM



<b>KAF49</b>	Universal sliding wind-screen, transparent, with 4 point handlebar, complete with fitting kit KD45 to be mounted instead of the original screen Maximum height 53 cm (12 cm of extension) width 52 cm	
<b>KD45</b>	Only fitting kit for KAF49	
<b>Z1963RK</b>	Airstream guide latch spare parts	



**AIRSTREAM** is the universal adjustable windscreen. The transparent polycarbonate spoiler can be moved along a 12cm axis and once at the desired height, it is secured with two sturdy plastic clamps. For increased protection against the wind, Airstream has been designed to create an aerodynamic effect which can limit possible turbulence to a minimum. To this characteristic we need to add the increased riding safety in the event of rain, achievable by completely lowering the spoiler. This operation eliminates the drops effect on the glass, which along with that formed on the helmet's visor, distorts images and is aggravating when riding in poor lighting conditions or after sundown. Airstream can also be easily left mounted during the summer months: the motorbike would simply have the lower section mounted to the vehicle and the moving spoiler would be completely removed.

→ **SPOILER**



**KA3113BL** Suzuki GSX S 750 (17 → 18)  
 Specific **BLUE LINE** screen  
 28 x 36,5 cm (H x W)



**KA1152BL** Honda CB500F (16 → 18)  
 Specific **BLUE LINE** screen  
 28 x 36,5 cm (H x W)



**KD4121GR** Kawasaki Versys-X 300 (17 → 18)  
 Specific **"LIME"** screen  
 41 x 40 cm (H x W)  
**→NEW**



**KA4118GR** Kawasaki Z900 (17 → 18)  
 Specific **"LIME"** screen  
 37 x 32 cm (H x W)  
**→NEW**



**KA4117GR** Kawasaki Z650 (17 → 18)  
 Specific **"LIME"** screen  
 28 x 33 cm (H x W)  
**→NEW**



**KA7708OR** Specific **"ORANGE"** screen,  
 25 x 31 cm (H x L)  
 complete with specific  
 fitting kit  
**→NEW**



**HONDA**

SH 125i-150i ABS (12 → 18)



**KTM**

Duke 790 (18)



**KAWASAKI**

Z 900 (17 → 18)

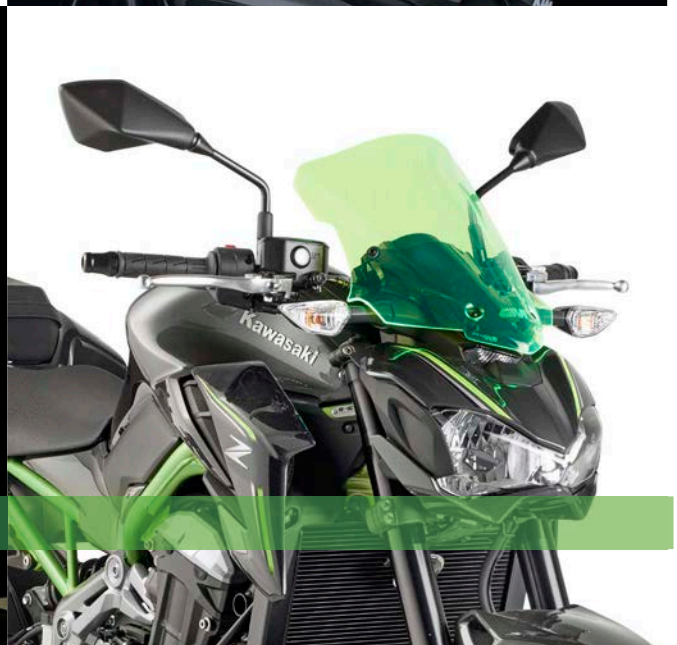

→ **EXTENSION FOR HANDS PROTECTOR**



**EH1110K** Honda Crosstourer 1200 / Crosstourer 1200 DCT (12 → 18)  
 Plexiglass extension for original hands protector, smoked



**EH5108K** BMW F 850 GS Adventure (13 → 17) / F 850 GS (18) / S 1000 XR (15 → 18) / R1200GS (13 → 18) / R 1200 GS Adventure (14 → 18) / R 1250 GS (19)  
 Plexiglass extension for original hands protector, smoked



**EH2130K** Yamaha MT-07 Tracer (16 → 18)  
 Extension in ABS for original hands protector



**EH2122K** Yamaha MT-09 Tracer (15 → 16)  
 Plexiglass extension for original hands protector, smoked



**EH2139K** Yamaha Tracer 900 (18)  
 Plexiglass extension for original hands protector, smoked

→SCREENS

**SPECIFIC RANGE** CONSULT THE SECTION "MY MOTORCYCLE" IN ORDER TO CHECK THE RANGE OF SPECIFIC PRODUCTS AVAILABLE FOR YOUR VEHICLE

## → HANDS PROTECTOR



<b>KHP1111</b>	HONDA NC 700 X (12 → 13) / NC 750 X / NC 750 X DCT (14 → 15) HONDA NC 750 S (16 → 18) HONDA NC 750 X (16 → 18)	
----------------	--	--



<b>KHP5117</b> ↘	BMW R1200 R (15 → 18)	
------------------	-----------------------	--



<b>KHP1121</b>	Honda CB500X (13 → 18)	
----------------	------------------------	--



<b>KHP1137</b>	HONDA CB 650 F (14 → 16) HONDA CBR 650 F (14 → 16)	
----------------	--	--



<b>KHP4121</b>	KAWASAKI VERSYS-X 300 (17→18)	
----------------	----------------------------------	--



<b>KHP3115</b>	SUZUKI Burgman 400 (17→18)	
----------------	-------------------------------	--



**SPECIFIC RANGE**

CONSULT THE SECTION "MY MOTORCYCLE" IN ORDER TO CHECK THE RANGE OF SPECIFIC PRODUCTS AVAILABLE FOR YOUR VEHICLE

## → DISPLAYS

	<b>K5014K</b> ↘	Display for K33N panniers	
<b>1</b>	<b>K5018K</b> ↘	Vertical display for soft bags	
<b>2</b>	<b>K6019</b>	KAPPA Carpet. Dimensions: (H x L) 150 x 200 cm	
	<b>K6040K</b> ↘	360° display for KAPPA accessories. Dimensions: (H x L) 183 x 55 cm	
<b>3</b>	<b>K6041K</b> ↘	Display rack for Airstream windshield, complete with the KAF330 specific for BMW R1200GS (04 → 10)	
	<b>K6044K</b>	Rotating floor display with a triangular column made of plastic material. Height 180 cm, base diameter 32 cm.	
<b>4</b>	<b>K6043EA</b>	Grey slat wall display shelf for TANKLOCK soft tank bags, can also be used as a counter display.	
<b>5</b>	<b>K6048K</b>	Display for 3 Garda cases. Dimensions: (H x L) 130 x 80 cm	
	<b>K6048EKIT</b>	Kit for mounting a right lateral Easylock bag RA314, on the display K6048K	
<b>6</b>	<b>K6049K</b> ↘	Grey wall metallic display. Dimensions: (H x L) 235 x 210 cm	
	<b>K6049BM</b> ↘	Support to display soft bags on K6049K	
	<b>K6049SP</b> ↘	Support to display windshields and screens on K6049K	
	<b>K6049TL</b> ↘	Support to display TANKLOCK bags on K6049K	
	<b>K6049CA</b> ↘	Support to display one helmet on K6049K	
	<b>K6049TG</b> ↘	Rear graphics banner	
	<b>K6049DEP</b> ↘	Brochure holder	
	<b>K6049PKIT</b> ↘	Kit composed of n°2 screws M6x40 to mount the MONOKEY® plates K609 or the universal MONOLOCK® plates onto the display K6049K	
<b>7</b>	<b>K6052K</b>	Display for 6 TANKLOCK soft bags	
<b>8</b>	<b>K6060K</b>	Display for 3 MONOKEY® or MONOLOCK® top-cases	
<b>9</b>	<b>K6059K</b>	Display for 8 helmets	



**1 K5018K**



**2 K6019**



**3 K6041K**



**4 K6043EA**





**5 K6048K**



**8 K6058E**



**9 K6059K**



**7 K6052K**



**6 K6049K**



## K6054K

Wall display to be combined with the supports K6043EA, K6043K33, K6043S, K6043SP, or K6043VA

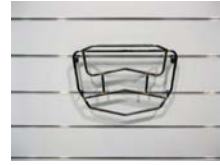

**1** K6043K9915



**2** K6043HP4103



**3** K6043MG4103



**4** K6043PH5108



**5** K6043SRA5116



**6** K6043TB2013

### SUPPORTS FOR TOP CASES, SIDE CASES, SCREENS AND HELMETS - K6054K

<b>K6043S</b>	Double hook to hang on a display wall packaged accessories with a European style hanging	
<b>K6043BA</b>	Support for MONOLOCK® and MONOKEY® cases, for slat walls	
<b>K6043BMG</b>	Support for soft bags, grey, for slat walls	
<b>K6043CAK</b>	Support for helmets, grey, for slat walls	
<b>K6043SP</b>	Support for screens and spoilers, for slat walls	
<b>K6043VA</b>	Support for MONOKEY® lateral cases, for slat walls	
<b>K6043K33</b>	Support for K33 MONOKEY® SIDE lateral cases, for slat walls	

### SUPPORTS FOR TECHNICAL PARTS - K6054K

<b>1</b>	<b>K6043K9915</b>	Support to display the small metal K9915 on slat walls or on K6054K	
	<b>K6043EH1110</b>	Support to display the extension hand protector EH1110K, left side, on slat walls or on K6054K	
	<b>K6043EX1SRA</b>	Support to display the extendable bag holder EX1SRAK on slat walls or on K6054K	
<b>2</b>	<b>K6043HP4103</b>	Support to display the hand protector KHP4103, left side, on slat walls or on K6054K	
<b>3</b>	<b>K6043MG4103</b>	Support to display the mudguard KMG4103 on slat walls or on K6054K	
<b>4</b>	<b>K6043PH5108</b>	Support to display the engine head protector PH5108K, right side, on slat walls or on K6054K	
<b>5</b>	<b>K6043SRA5116</b>	Support to display the rear rack in aluminium KRA5116 on slat walls or on K6054K	
<b>6</b>	<b>K6043TB2013</b>	Support to display the backrest KTB2013 on slat walls or on K6054K	
	<b>K6043TN5108OX</b>	Support to display the engine guard KN5108 or KN5108OX, right side, on slat walls or on K6054K	
	<b>K6043PR5108</b>	Support to display the radiator guard KPR5108 (one side) on slat walls or on K6054K	
	<b>K6043RP6403</b>	Support to display the oil carter protector KRP6403 on slat walls or on K6054K	
	<b>K6043S650</b>	Support to display the child's seat KS650 on slat walls or on K6054K	



**SPECIFIC  
RANGE**

→ SPECIFIC EQUIPMENT FOR  
MOTORCYCLES AND SCOOTERS

See the specific equipment for your bike sorted for model and engine size

### SPECIFIC FITTING KIT FOR HARD BAGS



FITTINGS for TOP CASEs

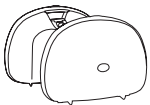

FITTINGS for SIDE CASES

### SPECIFIC HOLDERs FOR SOFT BAGS



FITTINGS for TANK BAGS with "tanklock system

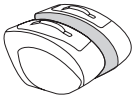

FITTINGS FOR SADDLE BAGS

### SCREENS



SPECIFIC SCREENS

### ENGINE GUARDS AND OIL CARTER PROTECTORS



ENGINE GUARDS AND OIL CARTER PROTECTOR











### ACCESSORIES















SPECIFIC BACKRESTS













**VARIOUS  
ACCESSORIES**



















MudguardS / ABS specific chain-coverS / RADIATOR GUARDS







Specific supportS to widen the surface support area of the original side stand

CODICE	DESCRIZIONE	PREZZO
<b>APRILIA</b>		
<b>APRILIA SCARABEO 50 STREET (09 → 13)</b>		
 <b>KR6705</b>	Specific rear rack for <b>MONOLOCK®</b> top-case <i>to be combined with the plate already included in the <b>MONOLOCK®</b> top-case</i>	
 <b>153AK</b>	Specific screen, transparent 56 x 66 cm (H x W) <i>to be combined with the specific A6704AK fitting kit</i>	
<b>A6704AK</b>	Specific fitting kit for 152A and 153AK	
<b>APRILIA SCARABEO 50-100 (09 → 13)</b>		
 <b>153AK</b>	Specific screen, transparent 56 x 66 cm (H x W) <i>to be combined with the specific A6704AK fitting kit</i>	
<b>A6704AK</b>	Specific fitting kit for 152A and 153AK	
You can fit a <b>MONOLOCK®</b> top-case using the universal plate included		
<b>APRILIA SCARABEO 50 (14 → 18)</b>		
 <b>KR6705</b>	Specific rear rack for <b>MONOLOCK®</b> top-case <i>to be combined with the plate already included in the <b>MONOLOCK®</b> top-case</i>	
 <b>6704AK</b>	Specific screen, transparent 56 x 66 cm (H x W) <i>to be combined with the specific A6704AK fitting kit</i>	
<b>A6704AK</b>	Specific fitting kit for 6704AK	
<b>APRILIA SPORTCITY ONE 50-125 (08 → 13)</b>		
 <b>134AK</b>	Specific screen, transparent 66 x 67 cm (H x W) <i>only available if article A151A is already fitted / with hand protectors</i>	
<b>136AK</b>	Specific screen, transparent 74 x 67 cm (H x W) <i>only available if article A151A is already fitted / with hand protectors</i>	
<b>APRILIA SR 50 DITECH (97 → 05)</b>		
 <b>KR78</b>	Specific rear rack for <b>MONOLOCK®</b> top-case <i>to be combined with the plate already included in the <b>MONOLOCK®</b> top-case</i>	
<b>APRILIA ATLANTIC 125-200-250-300 (03 → 13)</b>		
 <b>KD242ST</b>	Specific screen, transparent 84 x 70 cm (H x W) <i>to be mounted instead of the original screen / 19 cm higher than the original / with hand protectors</i>	
<b>APRILIA HABANA 125 (00 → 09)</b>		
 <b>KR74</b>	Specific rear rack for <b>MONOLOCK®</b> or <b>MONOKEY®</b> top-case <i>to be combined with the K636 <b>MONOKEY®</b> plate (sold separately), or with the plate already included in the <b>MONOLOCK®</b> top-cases</i>	
You can fit a <b>MONOLOCK®</b> top-case using the universal plate included		
<b>APRILIA RS 125</b>		
 <b>BF02K</b>	Specific flange for fitting the tank bags with TANKLOCK system	
<b>APRILIA SCARABEO 125-200 (07 → 06/11)</b>		
 <b>154AK</b>	Specific screen, transparent 53 x 70 cm (H x W) <i>to be combined with the specific A154AK fitting kit</i>	
<b>A154AK</b>	Specific fitting kit for 154AK	





CODICE	DESCRIZIONE	PRICE
<b>APRILIA SPORTCITY 125-200-250 (04 → 08)</b>		
 <b>105AK</b>	Specific screen, transparent 66 x 67 cm (H x W) <i>for '04 only available if article A128A is already fitted / to be combined with the specific A129AK fitting kit from '05</i>	
<b>128AK</b>	Specific screen, transparent 74 x 67 cm (H x W) <i>for '04 only available if article A128A is already fitted / to be combined with the specific A129AK fitting kit from '05 / 8 cm higher than 105AK</i>	
<b>A129AK</b>	Specific fitting kit for 128AK and 105AK <i>compatible from '05</i>	
<b>APRILIA SPORTCITY CUBE 125-200-300 (08 → 13)</b>		
 <b>134AK</b>	Specific screen, transparent 66 x 67 cm (H x W) <i>only available if article A150A is already fitted / with hand protectors</i>	
<b>136AK</b>	Specific screen, transparent 74 x 67 cm (H x W) <i>only available if article A150A is already fitted / with hand protectors</i>	
<b>APRILIA SCARABEO 250-300 (07 → 16)</b>		
 <b>KE7300</b>	Specific rear rack for <b>MONOLOCK</b> ® top-case <i>it is necessary to puncture the housing behind the saddle in arranged sections</i>	
 <b>130AK</b>	Specific screen, transparent 50 x 72 cm (H x W) ↳ <i>to be combined with the specific A148AK fitting kit/ With hand protectors / In order to install it use the original fitting kit of the scooter and the item A130A</i>	
<b>A148AK</b>	↳ Specific fitting kit for 130AK	
<b>APRILIA ATLANTIC 400-500 SPRINT (05 → 12)</b>		
 <b>KD242ST</b>	Specific screen, transparent 84 x 70 cm (H x W) <i>to be mounted instead of the original screen / 19 cm higher than the original / with hand protectors</i>	
<b>APRILIA SCARABEO 400-500 (06 → 12)</b>		
 <b>KE7300</b>	Specific rear rack for <b>MONOLOCK</b> ® top-case <i>it is necessary to puncture the housing behind the saddle in arranged sections</i>	
 <b>130AK</b>	↳ Specific screen, transparent 50 x 72 cm (H x W) <i>only available if article A130A is already fitted / In order to install it use the original fitting kit of the scooter and A130A / with hand protectors</i>	
<b>APRILIA ATLANTIC 500 (02 → 06)</b>		
 <b>KD240ST</b>	Specific screen, transparent 65 x 69 cm (H x W) <i>to be mounted instead of the original screen / 9 cm higher than the original</i>	
<b>APRILIA PEGASO 650 STRADA / TRAIL (05 → 11)</b>		
 <b>KR79</b>	Specific rear rack for <b>MONOKEY</b> ® top-case <b>MONOKEY</b> ® plate included / maximum load allowed 6 Kg	
<b>APRILIA SHIVER 750 / SHIVER GT 750 (07 → 12) / ABS (09 → 12)</b>		
 <b>BF02K</b>	Specific flange for fitting the tank bags with TANKLOCK system	
 <b>01SKITK</b>	Specific kit to mounting the KS900A Smart Bar	
<b>APRILIA SHIVER 750 / ABS (10 → 16)</b>		
 <b>KZ6702</b>	Specific rear rack for <b>MONOKEY</b> ® or <b>MONOLOCK</b> ® top-case <i>to be combined with the MONOKEY® KM5, KM7 plate, or with the MONOLOCK® KM5M or KM6M plate / a handle bar for the passenger is included, you must remove the original grab rails</i>	
 <b>TE6702K</b>	Specific holder for soft side bags or for semi-rigid side bags (RA314)	
 <b>BF02K</b>	Specific flange for fitting the tank bags with TANKLOCK system	
 <b>01SKITK</b>	Specific kit to mounting the KS900A Smart Bar	
<b>APRILIA DORSODURO 750 / DORSODURO 1200 (08 → 16)</b>		
 <b>KR6700M</b>	Specific rear rack for <b>MONOLOCK</b> ® top-case <b>MONOLOCK</b> ® plate included / you must puncture the housing in arranged sections	

CODICE	DESCRIZIONE	PREZZO
 <b>TE6700K</b>	Specific holder for soft side bags or for semi-rigid side bags (RA314)	
<b>VARIOUS ACCESSORIES</b> <b>01SKITK</b>	Specific kit to mounting the KS900A Smart Bar <i>also for ABS version</i>	
<b>APRILIA MANA 850 / MANA 850 GT (08 → 16)</b>		
 <b>KZ732</b>	Specific rear rack for <b>MONOKEY</b> ® or <b>MONOLOCK</b> ® top-case <i>to be combined with the MONOKEY® KM5, KM7, KM8A, KM8B, KM9A or KM9B plate, or with the MONOLOCK® KM5M or KM6M plate / if combined with KM8A, KM8B, KM9A, KM9B it does not allow the assembly of the stop light kit or the remote control device on the case / in order to install it you must remove the grab handles / it is compatible with the original side-case holders</i>	
<b>VARIOUS ACCESSORIES</b> <b>01SKITK</b>	Specific kit to mounting the KS900A Smart Bar	
<b>APRILIA SRV 850 (12 → 16)</b>		
 <b>KR6708</b>	Specific rear chromed rack for <b>MONOLOCK</b> ® or <b>MONOKEY</b> ® top-case <i>to be combined with the MONOKEY® KM5 plate, or with the MONOLOCK® KM5M or KM6M plate</i>	
 <b>KD6703ST</b>	Specific screen, transparent. 78 x 62 cm (H x W) <i>to be mounted instead of the original screen</i>	
<b>APRILIA ETV 1000 CAPONORD (01 → 10)</b>		
 <b>BF02K</b>	Specific flange for fitting the tank bags with TANKLOCK system	
 <b>KD239ST</b>	Specific screen, transparent 64 x 65,5 cm (H x W) <i>compatible until 2003 / to be mounted instead of the original screen</i>	
<b>APRILIA TUONO V4 R (11 → 14)</b>		
<b>VARIOUS ACCESSORIES</b> <b>01SKITK</b>	Specific kit to mounting the KS900A Smart Bar <i>for all versions</i>	
<b>APRILIA CAPONORD 1200 (13 → 17)</b>		
 <b>KRA6706</b>	Specific rear rack in aluminium for <b>MONOKEY</b> ® top-case <i>maximum load allowed 6kg / it does not allow the assembly of the stop light kit or the remote control device on the case</i>	
 <b>KD6706ST</b>	Specific screen, transparent 58 x 45 cm (H x W) <i>to be mounted instead of the original screen / 10 cm higher than the original</i>	
<b>VARIOUS ACCESSORIES</b> <b>ES6706K</b>	Specific support in aluminium and stainless steel to widen the surface support area of the original side stand	
<b>01SKITK</b>	Specific kit to mounting the KS900A Smart Bar	
<b>BENELLI</b>		
<b>BENELLI BN302 (15 → 18)</b>		
 <b>KR8702</b>	Specific rear rack for <b>MONOLOCK</b> ® top-case <i>to be combined with the plate already included in the MONOLOCK® top-case / it is necessary to remove the original grab handle</i>	
 <b>KL8702</b>	Specific pannier holder for <b>MONOKEY</b> ® side-cases <i>you can only mount cases MONOKEY® K22 / it can be mounted only with the specific rear rack KR8702</i>	
 <b>BF02K</b>	Specific flange for fitting the tank bags with TANKLOCK system <i>compatible with '15</i>	
<b>BF05K</b>	Specific flange for fitting the tank bags with TANKLOCK system <i>compatible from '16</i>	
 <b>247AK</b>	Universal screen, smoked 29 x 28,5 cm (H x W) <i>to be combined with the specific A8702AK fitting kit</i>	
<b>247NK</b>	Specific screen, black 29 x 28,5 cm (H x W) <i>to be combined with the specific A8702AK fitting kit</i>	
<b>A8702AK</b>	Specific fitting kit for 247AK and 247NK	
<b>VARIOUS ACCESSORIES</b> <b>03SKITK</b>	Specific kit to mounting the KS900A Smart Bar	











CODICE	DESCRIZIONE	PRICE
<b>BENELLI LEONCINO 500 (17 → 18)</b>		
 <b>KR8704</b>	Specific rear black rack for <b>MONOLOCK®</b> or <b>MONOKEY®</b> top-case <i>to be combined with the K636 MONOKEY® plate (sold separately), or with the plate already included in the MONOLOCK® top-cases / maximum load allowed 6 kg</i>	
 <b>KTL8704KIT</b>	Specific kit to install the KS250 Tool Box on the right-hand side of the motorcycle <i>to be combined with KS250 / needs to be mounted on the right-hand side of the motorcycle</i>	
 <b>TMT8704K</b>	Specific holder for one left CR601U side bag	
 <b>100ALK</b>	Grey anodized aluminium universal screen Race Cafe, for naked motorcycles 20,5 x 26,5 cm (H x W) <i>to be combined with the specific AL8704AK fitting kit</i>	
<b>100ALBK</b>	Black anodized aluminium universal screen Race Cafe, for naked motorcycles 20,5 x 26,5 cm (H x W) <i>to be combined with the specific AL8704AK fitting kit</i>	
<b>140AK</b>	Universal transparent screen 35 x 41cm (H x W) <i>to be combined with the specific AL8704AK fitting kit</i>	
<b>140SK</b>	Universal smoked screen 35 x 41 cm (H x W) <i>to be combined with the specific AL8704AK fitting kit</i>	
<b>AL8704AK</b>	Specific fitting kit for 100ALK, 100ALBK, 140AK, 140SK	
 <b>KN8704</b>	Specific engine guard, gloss black <i>25 mm diameter steel tube / we recommend fitting by a qualified mechanic</i>	
<b>BENELLI TRK502 (17 → 18)</b>		
 <b>K636</b>	Universal <b>MONOKEY®</b> plate with fitting kit to fit a case on a scooter already with a rack	
 <b>KL8703</b>	Specific pannier holder for <b>MONOKEY®</b> , RETRO FIT side-cases	
 <b>KTL8705KIT</b>	Specific kit to install the KS250 Tool Box on KL8703 <i>to be combined with KS250 and KL8703 / needs to be mounted on the left-hand side of the motorcycle</i>	
 <b>KD8703ST</b>	Specific screen, transparent 52 x 38 cm (H x W) <i>to be mounted instead of the original screen</i>	
 <b>KN8703</b>	Specific engine guard, black <i>25 mm diameter steel tube / we recommend fitting by a qualified mechanic</i>	
<b>KNH8703</b>	Specific engine guard, black <i>25 mm diameter steel tube / we recommend fitting by a qualified mechanic / it protects the upper part of the radiators</i>	
<b>VARIOUS ACCESSORIES</b> <b>05SKITK</b>	Specific kit to mounting the KS900A Smart Bar	
<b>BENELLI TRK502 X (18) NEW</b>		
 <b>K636</b>	Universal <b>MONOKEY®</b> plate with fitting kit to fit a case on a scooter already with a rack	
 <b>KL8705</b>	Specific pannier holder for <b>MONOKEY®</b> , RETRO FIT side-cases	
 <b>KTL8705KIT</b>	Specific kit to install the KS250 Tool Box on KL8705 <i>to be combined with KS250 and KL8705 / needs to be mounted on the left-hand side of the motorcycle</i>	
 <b>KD8703ST</b>	Specific screen, transparent 52 x 38 cm (H x W) <i>to be mounted instead of the original screen</i>	
 <b>KN8703</b>	Specific engine guard, black <i>it must be mounted with KN8703KIT / 25 mm diameter steel tube / we recommend fitting by a qualified mechanic</i>	
<b>KN8703KIT</b>	Specific kit to install the KN8703	
<b>BENELLI BN600 (13 → 17)</b>		
 <b>KL8701</b>	↘ Specific pannier holder for <b>MONOKEY®</b> , RETRO FIT side-cases	
 <b>BF02K</b>	Specific flange for fitting the tank bags with TANKLOCK system	
 <b>KA8701</b>	↘ Specific screen, black 28,5 x 36 cm (H x W) <i>complete with specific fitting kit</i>	
<b>VARIOUS ACCESSORIES</b> <b>03SKITK</b>	Specific kit to mounting the KS900A Smart Bar	













CODICE	DESCRIZIONE	PREZZO
<b>BENELLI</b>  <b>BF02K</b>	<b>CAFÈ RACER 899 (10)</b> Specific flange for fitting the tank bags with TANKLOCK system	
<b>BENELLI</b>  <b>BF02K</b>	<b>TRE 899 K / TRE 11130 K (06 → 16)</b> Specific flange for fitting the tank bags with TANKLOCK system	
<b>BENELLI</b>  <b>BF02K</b>	<b>TORNADO NAKED TRE 899 (10)</b> Specific flange for fitting the tank bags with TANKLOCK system	
<b>BENELLI</b>  <b>BF02K</b>	<b>TORNADO NAKED TRE 899S (10)</b> Specific flange for fitting the tank bags with TANKLOCK system	
<b>BENELLI</b>  <b>BF02K</b>	<b>CAFÈ RACER 1130 (10)</b> Specific flange for fitting the tank bags with TANKLOCK system	
<b>BENELLI</b>  <b>BF02K</b>	<b>TITANIUM (10)</b> Specific flange for fitting the tank bags with TANKLOCK system	
<b>BENELLI</b>  <b>BF02K</b>	<b>TORNADO NAKED TRE R160 (10)</b> Specific flange for fitting the tank bags with TANKLOCK system	

## BMW





<b>BMW</b>  <b>K108</b>	<b>K 100 (90)</b> Specific rear rack for <b>MONOKEY</b> ® top-case <b>MONOKEY</b> ® plate included / it is necessary to puncture the housing behind the saddle	
<b>BMW</b>  <b>KR5125</b>	<b>G 310 R (17 → 18)</b> Specific rear rack for <b>MONOLOCK</b> ® or <b>MONOKEY</b> ® top-case to be combined with the <b>MONOKEY</b> ® KM5, KM7, KM8A, KM8B, KM9A or KM9B plate, or with the <b>MONOLOCK</b> ® KM5M or KM6M plate, or with the plate already included in the <b>MONOLOCK</b> ® top-cases / if combined with KM8A, KM8B, KM9A, KM9B it does not allow the assembly of the stop light kit or the remote control device on the case / maximum load allowed 6 kg	
 <b>TE5125K</b>	Specific holder for soft side bags or for semi-rigid side bags (RA314)	
 <b>BF31K</b>	Specific flange for fitting the tank bags with TANKLOCK system	
 <b>KA5125</b>	Specific screen, smoked 28 x 36,5 cm (H x W) complete with specific fitting kit	
<b>KA5125BL</b>	Specific screen, BLUE LINE 28 x 36,5 cm (H x W) complete with specific fitting kit / when illuminated by vehicle headlights in low light conditions, the edge glows blue in colour	
<b>VARIOUS ACCESSORIES</b> <b>KHP4103</b>	Specific hands protector in ABS	
<b>05SKITK</b>	Specific kit to mounting the KS900A Smart Bar	



CODICE	DESCRIZIONE	PRICE
<b>BMW G 310 GS (17 → 18)</b>		
 <b>KR5126</b>	Specific rear rack for <b>MONOLOCK®</b> or <b>MONOKEY®</b> top-case to be combined with the <b>MONOKEY®</b> KM5, KM8A, KM8B, KM9A or KM9B plate, or with the <b>MONOLOCK®</b> KM5M or KM6M plate or with the plate already included in the <b>MONOLOCK®</b> top-cases / if combined with KM8A, KM8B, KM9A, KM9B it does not allow the assembly of the stop light kit or the remote control device on the case / maximum load allowed 6 kg	
 <b>KL5126</b>	Specific pannier holder for <b>MONOKEY®</b> , RETRO FIT side-cases	
<b>KTL1156KIT</b>	Specific kit to install the KS250 Tool Box on KL5126 to be combined with KS250 and KL5126 / needs to be mounted on the left-hand side of the motorcycle	
 <b>BF31K</b>	Specific flange for fitting the tank bags with TANKLOCK system	
 <b>KD5126ST</b>	Specific screen, transparent 47 x 37 cm (H x W) to be mounted instead of the original screen / 27 cm higher than the original	
 <b>KN5126</b>	Specific engine guard, black 25 mm diameter steel tube / we recommend fitting by a qualified mechanic	
<b>KPR5126</b>	Stainless steel specific radiator guard black painted	
<b>VARIOUS ACCESSORIES</b> <b>KRM01</b>	Universal spray guard It needs to be paired with the specific mounting kit (RM5126KITK)	
<b>KRM02</b>	Universal spray guard It needs to be paired with the specific mounting kit (RM5126KITK)	
<b>RM5126KITK</b>	Specific kit for spray guard KRM01, KRM02	
<b>KMG5126</b>	Specific ABS mudguard, black colour	
<b>LS5126K</b>	Specific fitting kit to mount KS310 or KS322 spotlights where specific engine guard is not present	
<b>KHP5126</b>	Specific hands protector in ABS	
<b>ES5126K</b>	Specific support in aluminium and stainless steel to widen the surface support area of the original side stand	
<b>KFB5126</b>	Fairing upper bracket to be mounted behind the windshield to install KS920M, KS920L and GPS-Smartphone holder For KS920M, KS920L, KS952B, KS953B, KS954B, KS955B, KS956B, KS957B	
<b>05SKITK</b>	Specific kit to mounting the KS900A Smart Bar	
<b>BMW C 400 X (19) NEW</b>		
 <b>KR5130</b>	Specific rear rack for <b>MONOLOCK®</b> or <b>MONOKEY®</b> top-case to be combined with the <b>MONOKEY®</b> KM5, KM7, KM8A, KM8B, KM9A or KM9B plate, or with the <b>MONOLOCK®</b> KM5M or KM6M plate / if combined with KM8A, KM8B, KM9A, KM9B it does not allow the assembly of the stop light kit or the remote control device on the case / maximum load allowed 6 kg	
<b>BMW C 600 SPORT (12 → 15)</b>		
 <b>KR5105</b>	Specific rear rack for <b>MONOKEY®</b> top-case <b>MONOKEY®</b> plate included	
<b>KR5105M</b>	Specific rear rack for <b>MONOLOCK®</b> top-case <b>MONOLOCK®</b> plate included	
<b>BMW C 650 GT (12 → 18)</b>		
 <b>KRA5106</b>	Specific rear rack in aluminium for <b>MONOKEY®</b> top-case maximum load allowed 6kg / it does not allow the assembly of the stop light kit or the remote control device on the case	
<b>BMW C 650 SPORT (16 → 18)</b>		
 <b>KR5121</b>	Specific rear rack for <b>MONOLOCK®</b> or <b>MONOKEY®</b> top-case to be combined with the <b>MONOKEY®</b> KM5, KM7, KM8A, KM8B, KM9A or KM9B plate, or with the <b>MONOLOCK®</b> KM5M or KM6M plate / if combined with KM8A, KM8B, KM9A, KM9B it does not allow the assembly of the stop light kit or the remote control device on the case / maximum load allowed 6 kg	
 <b>KD5121ST</b>	Specific screen, transparent, 71 x 53 cm (H x W) To be mounted instead of the original screen	
<b>VARIOUS ACCESSORIES</b> <b>KTB5121</b>	Specific backrest it cannot be mounted if rack and case are installed	
<b>BMW F 650 (94 → 96)</b>		
 <b>KD230S</b>	Specific screen, smoked 45,7 x 42,3 cm (H x W) to be mounted instead of the original screen	

→ CODICE	DESCRIZIONE	PREZZO
<b>BMW F 650 CS SCARVER (02 → 06)</b>		
 <b>KR682M</b>	Specific rear rack for <b>MONOLOCK®</b> top-case <b>MONOLOCK®</b> plate included / maximum load allowed 8 Kg	
<b>BMW F 650 GS (00 → 03)</b>		
 <b>K6390</b>	Specific rear rack for <b>MONOKEY®</b> or <b>MONOLOCK®</b> top-case To be combined with the plate <b>MONOKEY®</b> K553N, or with the plate <b>MONOLOCK®</b> MKN / it cannot be mounted with the original side-case holder / compatible from august '00	
 <b>KL188</b>	Specific pannier holder for <b>MONOKEY®</b> , RETRO FIT side-cases	
 <b>KD234S</b>	Specific screen, smoked 41,1 x 34 cm (H x W) to be mounted instead of the original screen	
<b>BMW F 650 GS (04 → 07)</b>		
 <b>KR685</b>	Specific rear rack for <b>MONOKEY®</b> top-case	
 <b>KL188</b>	Specific pannier holder for <b>MONOKEY®</b> , RETRO FIT side-cases	
 <b>KD331ST</b>	Specific screen, transparent 39,5 x 44 cm (H x W) to be mounted instead of the original screen / 15,5 cm higher than original / not mounted with original guards	
<b>BMW F 650 GS / F 800 GS (08 → 17)</b>		
 <b>KRA5103</b>	Specific rear rack in aluminium for <b>MONOKEY®</b> top-case can not be mounted with art. KL690 / maximum load allowed 6kg / it does not allow the assembly of the stop light kit or the remote control device on the case	
<b>KR5107</b>	Specific rear rack for <b>MONOKEY®</b> top-case can not be mounted with art. KL690 / <b>MONOKEY®</b> plate included	
<b>K94</b>	Specific rear rack for <b>MONOKEY®</b> top-case <b>MONOKEY®</b> plate included / Is compatible with the rear plate / only for F 650 GS / F 800 GS (08-11)	
<b>K94M</b>	Specific rear rack for <b>MONOLOCK®</b> top-case <b>MONOLOCK®</b> plate included / only for F 650 GS / F 800 GS (08-11)	
 <b>KL690</b>	Specific pannier holder for <b>MONOKEY®</b> , RETRO FIT side-cases it can be mounted only with the specific plate K94 or K94M / only for F 650 GS / F 800 GS (08>11)	
<b>KLR5103</b>	Specific rapid release side-case holder for <b>MONOKEY®</b> , RETRO FIT cases from 2012	
<b>KS250KIT *</b>	Universal kit to install the KS250 Tool Box needs to be mounted on the right-hand side of the KLR5103 / To be combined with KS250 and the specific pannier holder	
 <b>BF15K</b>	Specific flange for fitting the tank bags with TANKLOCK system	
 <b>333DTK</b>	Specific screen, transparent 44 x 46 cm (H x W) to be combined with the specific D333KITK fitting kit/ 26 cm higher than the original F650GS / 22 cm higher than the original F800GS	
<b>D333KITK</b>	Specific fitting kit for 333DTK	
<b>5107DTK</b>	Specific screen, transparent 50 x 49 cm (H x W) to be combined with the specific D5107KIT fitting kit	
<b>D5107KITK</b>	Specific fitting kit for 5107DTK	
 <b>KN690</b>	Specific engine guard 25 mm diameter steel tube / we recommend fitting by a qualified mechanic	
<b>KN5103</b>	Specific engine guard only for F800GS / compatible from '13 / 25 mm diameter steel tube / we recommend fitting by a qualified mechanic / black colour	
<b>RP5103K</b>	Oil carter protector in Aluminium	
<b>VARIOUS ACCESSORIES</b> <b>KHP5103</b>	Specific hands protector in ABS only for F800GS / compatible from '13	
<b>ES5107K</b>	Specific support in aluminium and stainless steel to widen the surface support area of the original side stand only for BMW F650GS from '13	
<b>ES5103K</b>	Specific support in aluminium and stainless steel to widen the surface support area of the original side stand only for F800GS	
<b>01SKITK</b>	Specific kit to mounting the KS900A Smart Bar	

\* In the event that the KS250 Tool Box and KS250KIT are mounted on a side-case holder and compatibility has not been verified by KAPPA, then before hitting the road, it is essential to check that nothing (including the Tool Box) interferes with the full range of movements of the swingarm.

CODICE	DESCRIZIONE	PRICE
<b>BMW F 650 GS DAKAR (00 → 03)</b>		
 <b>K6390</b>	Specific rear rack for <b>MONOKEY</b> ® or <b>MONOLOCK</b> ® top-case <i>To be combined with the plate <b>MONOKEY</b>® K553N, or with the plate <b>MONOLOCK</b>® MKN / it cannot be mounted with the original side-case holder / compatible from august '00</i>	
 <b>KL188</b>	Specific pannier holder for <b>MONOKEY</b> ®, RETRO FIT side-cases	
<b>BMW F 650 ST (97 → 99)</b>		
 <b>KL185</b>	Specific pannier holder for <b>MONOKEY</b> ®, RETRO FIT side-cases	
<b>BMW G 650 GS (11 → 17)</b>		
 <b>KR685</b>	Specific rear rack for <b>MONOKEY</b> ® top-case	
 <b>KL188</b>	Specific pannier holder for <b>MONOKEY</b> ®, RETRO FIT side-cases	
 <b>BF19K</b>	Specific flange for fitting the tank bags with TANKLOCK system	
 <b>KD5101ST</b>	Specific screen, transparent 41 x 39 cm (H x W) <i>to be mounted instead of the original screen / 22 cm higher than the original</i>	
 <b>KN5101</b>	Specific engine guard <i>25 mm diameter steel tube / we recommend fitting by a qualified mechanic</i>	
<b>VARIOUS ACCESSORIES</b> <b>KHP5101</b>	Specific hands protector in ABS	
<b>ES5101K</b>	Specific support in aluminium and stainless steel to widen the surface support area of the original side stand	
<b>01SKITK</b>	Specific kit to mounting the KS900A Smart Bar	
<b>BMW F 700 GS (13 → 17)</b>		
 <b>KRA5103</b>	Specific rear rack in aluminium for <b>MONOKEY</b> ® top-case <i>maximum load allowed 6kg / it does not allow the assembly of the stop light kit or the remote control device on the case</i>	
<b>KR5107</b>	Specific rear rack for <b>MONOKEY</b> ® top-case <b>MONOKEY</b> ® plate included	
 <b>KLR5103</b>	Specific rapid release side-case holder for <b>MONOKEY</b> ®, RETRO FIT cases <i>from 2012</i>	
 <b>BF15K</b>	Specific flange for fitting the tank bags with TANKLOCK system	
 <b>333DTK</b>	Specific screen, transparent 44 x 46 cm (H x W) <i>to be combined with the specific D333KITK fitting kit/ 26 cm higher than the original F650GS / 22 cm higher than the original F800GS</i>	
<b>D333KITK</b>	Specific fitting kit for 333DTK	
<b>5107DTK</b>	Specific screen, transparent 50 x 49 cm (H x W) <i>to be combined with the specific D5107KIT fitting kit</i>	
<b>D5107KITK</b>	Specific fitting kit for 5107DTK	
<b>KAF5107</b>	Specific Airstream sliding wind-screen transparent. Maximum height 53 cm (12 cm of excursion), width 51 cm <i>complete with specific fitting kit</i>	
 <b>KN5103</b>	Specific engine guard <i>25 mm diameter steel tube / we recommend fitting by a qualified mechanic / black colour</i>	
<b>KN690</b>	Specific engine guard <i>25 mm diameter steel tube / we recommend fitting by a qualified mechanic</i>	
<b>RP5103K</b>	Oil carter protector in Aluminium	
<b>VARIOUS ACCESSORIES</b> <b>KHP5103</b>	Specific hands protector in ABS	
<b>ES5107K</b>	Specific support in aluminium and stainless steel to widen the surface support area of the original side stand	
<b>01SKITK</b>	Specific kit to mounting the KS900A Smart Bar	

→ CODICE	DESCRIZIONE	PREZZO
-------------	-------------	--------

**BMW K75 750**

 **K108** Specific rear rack for **MONOKEY**® top-case  
**MONOKEY**® plate included / it is necessary to puncture the housing behind the saddle

**BMW F 750 GS (18) NEW**

 **KRA5127** Specific rear rack in aluminium for **MONOKEY**® top-case  
maximum load allowed 6kg / it does not allow the assembly of the stop light kit or the remote control device on the top-case / it can only be mounted to the original rack in aluminium

**KR5129** Specific rear rack for **MONOLOCK**® or **MONOKEY**® top-case  
to be combined with the **MONOKEY**® KM5, KM8A, KM8B, KM9A or KM9B plate, or with the **MONOLOCK**® KM5M or KM6M plate / if combined with KM8A, KM8B, KM9A, KM9B it does not allow the assembly of the stop light kit or the remote control device on the case / maximum load allowed 6 kg / it can only be mounted to the original plastic rack

 **KLR5127** Specific rapid release side-case holder for **MONOKEY**®, RETRO FIT cases

**KTL5127PLRKIT** Specific kit to install the KS250 Tool Box on KLR5127  
to be combined with KS250 and KLR5127 / needs to be mounted on the left-hand side of the motorcycle

 **BF11K** Specific flange for fitting the tank bags with TANKLOCK system

 **KD5127S** Specific screen, smoked 44 x 47 cm (H x W)  
to be combined with the specific D5129KITK fitting kit / 17 cm higher than the original

**KD5127ST** Specific screen, transparent 54,5 x 49 cm (H x W)  
to be combined with the specific D5129KITK fitting kit / 27 cm higher than the original

**KAF5127** Specific sliding wind-screen transparent, Airflow. Maximum height 59 cm (12 cm of extension), width 49 cm  
to be combined with the specific D5129KITK fitting kit / to be mounted instead of the original screen

**D5129KITK** Specific fitting kit for KD5127S, KD5127ST, KAF5127

 **KN5127** Specific engine guard, black  
25 mm diameter steel tube / we recommend fitting by a qualified mechanic

**KN51270X** Specific engine guard, stainless steel  
25 mm diameter steel tube / we recommend fitting by a qualified mechanic

**RP5129K** Oil carter protector in Aluminium

**VARIOUS ACCESSORIES RP5129KITK** Specific kit to install the RP5129K

**LS5127K** Specific fitting kit to mount KS310 or KS322 spotlights where specific engine guard is not present

**KHP5129** Specific hands protector in ABS

**ES5127K** Specific support in aluminium and stainless steel to widen the surface support area of the original side stand

**KFB2130 \*** Fairing upper bracket to be mounted behind the windshield to install KS920M, KS920L and GPS-Smartphone holder

**01SKITK** Specific kit to mounting the KS900A Smart Bar

\* Look for the section to verify the compatibility of products for your motorcycle

**BMW F 800 GS ADVENTURE (13 → 18)**

 **KRA5103** Specific rear rack in aluminium for **MONOKEY**® top-case  
maximum load allowed 6kg / it does not allow the assembly of the stop light kit or the remote control device on the case

**KR5107** Specific rear rack for **MONOKEY**® top-case  
**MONOKEY**® plate included

 **BF15K** Specific flange for fitting the tank bags with TANKLOCK system

 **KD5110ST** Specific screen, transparent 48 x 55 cm (H x W)  
to be mounted instead of the original screen / 17 cm higher than the original

**KAF5110** Specific sliding wind-screen transparent, AIRSTREAM for BMW F 800 GS Adventure (13 → 17). Maximum height 54 cm (12 cm of extension), width 56 cm  
to be mounted instead of the original screen

















 **KNH51230X** Specific engine guard, stainless steel  
25 mm diameter steel tube / we recommend fitting by a qualified mechanic / it protects the upper part of the radiators













**RP5103K** Oil carter protector in Aluminium

















**VARIOUS ACCESSORIES EH5108K** Plexiglass extension for original hands protector, smoked

**ES5103K** Specific support in aluminium and stainless steel to widen the surface support area of the original side stand

**01SKITK** Specific kit to mounting the KS900A Smart Bar



CODICE	DESCRIZIONE	PRICE
<b>BMW F 800 GT (13 → 18)</b>		
 <b>KR5109</b>	Specific rear rack for <b>MONOKEY</b> ® top-case <b>MONOKEY</b> ® plate included	
 <b>KLR5118</b>	Specific rapid release side-case holder for <b>MONOKEY</b> ® cases <i>It can only be mounted to the original rack / not compatible with the side-cases in aluminium KVE37 K-venture</i>	
 <b>TE5118K</b>	Specific holder for soft side bags or for semi-rigid side bags (RA314)	
 <b>BF16K</b>	Specific flange for fitting the tank bags with TANKLOCK system	
 <b>KD5109ST</b>	Specific screen, transparent 62 x 58 cm (H x W) <i>to be mounted instead of the original screen / 17.5 cm higher than original</i>	
<b>VARIOUS ACCESSORIES</b> <b>ES5118K</b>	Specific support in aluminium and stainless steel to widen the surface support area of the original side stand	
<b>01SKITK</b>	Specific kit to mounting the KS900A Smart Bar	
<b>BMW F 800 R (09 → 14)</b>		
 <b>KRA691</b>	Specific rear rack in aluminium for <b>MONOKEY</b> ® top-case <i>can not be mounted with the original side-case / maximum load allowed 6kg / it does not allow the assembly of the stop light kit or the remote control device on the case</i>	
 <b>KLR5118</b>	Specific rapid release side-case holder for <b>MONOKEY</b> ® cases <i>to be combined with the kit KLR5118KIT when the original plastic grab handles are mounted / It can only be mounted to the original rack / not compatible with the side-cases in aluminium KVE37 K-venture</i>	
<b>KLR5118KIT</b>	Specific kit to mount the KLR5118 on BMW F800R with the original plastic grab handles	
 <b>TE5118K</b>	Specific holder for soft side bags or for semi-rigid side bags (RA314)	
 <b>BF16K</b>	Specific flange for fitting the tank bags with TANKLOCK system	
 <b>KN691</b>	Specific engine guard <i>25 mm diameter steel tube / we recommend fitting by a qualified mechanic / black colour</i>	
<b>VARIOUS ACCESSORIES</b> <b>01SKITK</b>	Specific kit to mounting the KS900A Smart Bar	
<b>BMW F 800 R (15 → 18)</b>		
 <b>KRA691</b>	Specific rear rack in aluminium for <b>MONOKEY</b> ® top-case <i>can not be mounted with the original side-case / maximum load allowed 6kg / it does not allow the assembly of the stop light kit or the remote control device on the case</i>	
<b>KR5109</b>	Specific rear rack for <b>MONOKEY</b> ® top-case <i>it can only be mounted to the original rack BMW, which is available as an optional extra / <b>MONOKEY</b>® plate included</i>	
 <b>KLR5118</b>	Specific rapid release side-case holder for <b>MONOKEY</b> ® cases <i>to be combined with the kit KLR5118KIT when the original plastic grab handles are mounted / It can only be mounted to the original rack / not compatible with the side-cases in aluminium KVE37 K-venture</i>	
<b>KLR5118KIT</b>	Specific kit to mount the KLR5118 on BMW F800R with the original plastic grab handles	
 <b>TE5118K</b>	Specific holder for soft side bags or for semi-rigid side bags (RA314)	
 <b>BF16K</b>	Specific flange for fitting the tank bags with TANKLOCK system	
 <b>KA5118</b>	Specific screen, smoked 28,5 x 36 cm (H x W) <i>to be mounted instead of the original screen / complete with fitting kit</i>	
<b>VARIOUS ACCESSORIES</b> <b>KHP5118</b>	Specific hands protector in ABS	
<b>ES5118K</b>	Specific support in aluminium and stainless steel to widen the surface support area of the original side stand	
<b>05SKITK</b>	Specific kit to mounting the KS900A Smart Bar	
<b>BMW F 800 ST (06 → 16)</b>		
 <b>KR5109</b>	Specific rear rack for <b>MONOKEY</b> ® top-case <b>MONOKEY</b> ® plate included	
<b>BMW R 850 GS (94 → 01)</b>		
 <b>KL189</b>	Specific pannier holder for <b>MONOKEY</b> ®, RETRO FIT side-cases	

→	CODICE	DESCRIZIONE	PREZZO
<b>BMW R 850 R (95 → 02)</b>			
	<b>K6350</b>	Specific rear rack for <b>MONOKEY</b> ® or <b>MONOLOCK</b> ® top-case <i>To be combined with the plate <b>MONOKEY</b>® K553N, or with the plate <b>MONOLOCK</b>® MKN/ it is compatible with the original side-case holder</i>	
<b>BMW F 850 GS (18) <span style="background-color: orange; color: white; padding: 2px;">NEW</span></b>			
	<b>KRA5127</b>	Specific rear rack in aluminium for <b>MONOKEY</b> ® top-case <i>maximum load allowed 6kg / it does not allow the assembly of the stop light kit or the remote control device on the top-case / it can only be mounted to the original rack in aluminium</i>	
	<b>KR5129</b>	Specific rear rack for <b>MONOLOCK</b> ® or <b>MONOKEY</b> ® top-case <i>to be combined with the <b>MONOKEY</b>® KM5, KM8A, KM8B, KM9A or KM9B plate, or with the <b>MONOLOCK</b>® KM5M or KM6M plate / if combined with KM8A, KM8B, KM9A, KM9B it does not allow the assembly of the stop light kit or the remote control device on the case / maximum load allowed 6 kg / it can only be mounted to the original plastic rack</i>	
	<b>KLR5127</b>	Specific rapid release side-case holder for <b>MONOKEY</b> ®, RETRO FIT cases	
	<b>KTL5127PLRKIT</b>	Specific kit to install the KS250 Tool Box on KLR5127 <i>to be combined with KS250 and KLR5127 / needs to be mounted on the left-hand side of the motorcycle</i>	
	<b>BF11K</b>	Specific flange for fitting the tank bags with TANKLOCK system	
	<b>KD5127S</b>	Specific screen, smoked 44 x 47 cm (H x W) <i>to be mounted instead of the original screen / 17 cm higher than the original</i>	
	<b>KD5127ST</b>	Specific screen, transparent 54,5 x 49 cm (H x W) <i>to be mounted instead of the original screen / 27 cm higher than the original</i>	
	<b>KAF5127</b>	Specific sliding wind-screen transparent, Airflow. Maximum height 59 cm (12 cm of extension), width 49 cm <i>to be mounted instead of the original screen</i>	
	<b>KN5127</b>	Specific engine guard, black <i>25 mm diameter steel tube / we recommend fitting by a qualified mechanic</i>	
	<b>KN51270X</b>	Specific engine guard, stainless steel <i>25 mm diameter steel tube / we recommend fitting by a qualified mechanic</i>	
	<b>RP5127K</b> ↘	Oil carter protector in Aluminium	
	<b>RP5129K</b>	Oil carter protector in Aluminium	
<b>VARIOUS ACCESSORIES</b>	<b>ES5127K</b>	Specific support in aluminium and stainless steel to widen the surface support area of the original side stand	
	<b>EH5108K</b>	Plexiglass extension for original hands protector, smoked	
	<b>LS5127K</b>	Specific fitting kit to mount KS310 or KS322 spotlights where specific engine guard is not present	
	<b>KFB5127</b>	Fairing upper bracket to be mounted behind the windshield to install KS920M, KS920L and GPS-Smartphone holder <i>For KS920M, KS920L, KS952B, KS953B, KS954B, KS955B, KS956B, KS957B</i>	
	<b>01SKITK</b>	Specific kit to mounting the KS900A Smart Bar	
<b>BMW S 1000 RR (12 → 18)</b>			
	<b>BF22K</b>	Specific flange for fitting the tank bags with TANKLOCK system	
<b>BMW S 1000 R (14 → 18)</b>			
	<b>BF22K</b>	Specific flange for fitting the tank bags with TANKLOCK system	
	<b>KPR5119</b>	Specific protection for water and oil radiators, made from black painted stainless steel	
<b>BMW S 1000 XR (15 → 18)</b>			
	<b>KRA5119</b>	Specific rear rack in aluminium for <b>MONOKEY</b> ® top-case <i>maximum load allowed 6kg / it does not allow the assembly of the stop light kit or the remote control device on the case</i>	
	<b>KLR5119</b>	Specific rapid release side-case holder for <b>MONOKEY</b> ®, RETRO FIT cases	
	<b>KLXR5119</b>	Specific rapid release side-case holder for K33 <b>MONOKEY</b> ® <b>SIDE</b> cases	
	<b>BF11K</b>	Specific flange for fitting the tank bags with TANKLOCK system	
	<b>KD5119S</b>	Specific screen, smoked 50 x 43,5 cm (H x W) <i>to be mounted instead of the original screen / 13 cm higher than the original</i>	
	<b>KD5119ST</b>	Specific screen, transparent, 50 x 43,5 cm (H x W) <i>to be mounted instead of the original screen / 13 cm higher than the original</i>	









CODICE	DESCRIZIONE	PRICE
 <b>KN5119</b>	Specific engine guard, black <i>25 mm diameter steel tube / we recommend fitting by a qualified mechanic</i>	
<b>KPR5119</b>	Specific protection for water and oil radiators, made from black painted stainless steel	
<b>VARIOUS ACCESSORIES</b> <b>KHP5119</b>	Specific hands protector in ABS	
<b>EH5108K</b>	Plexiglass extension for original hands protector, smoked	
<b>ES5119K</b>	Specific support in aluminium and stainless steel to widen the surface support area of the original side stand	
<b>01SKITK</b>	Specific kit to mounting the KS900A Smart Bar	
<b>BMW</b>	<b>K 1100 RS</b>	
 <b>K108</b>	Specific rear rack for <b>MONOKEY</b> ® top-case <b>MONOKEY</b> ® plate included / it is necessary to puncture the housing behind the saddle	
<b>BMW</b>	<b>R 1100 GS (94 → 99)</b>	
 <b>KR694</b>	Specific rear rack for <b>MONOKEY</b> ® top-case <b>MONOKEY</b> ® plate included	
 <b>KL189</b>	Specific pannier holder for <b>MONOKEY</b> ®, RETRO FIT side-cases	
<b>BMW</b>	<b>R 1100 R (95 → 01)</b>	
 <b>K6350</b>	Specific rear rack for <b>MONOKEY</b> ® or <b>MONOLOCK</b> ® top-case <i>To be combined with the plate <b>MONOKEY</b>® K553N, or with the plate <b>MONOLOCK</b>® MKN/ it is compatible with the original side-case holder</i>	
<b>BMW</b>	<b>R 1100 RS (94 → 98)</b>	
 <b>K83</b>	Specific rear rack for <b>MONOKEY</b> ® top-case <i>to fit to the original rack</i>	
<b>BMW</b>	<b>R 1100 RT (96 → 00)</b>	
 <b>K83</b>	Specific rear rack for <b>MONOKEY</b> ® top-case <i>to fit to the original rack</i>	
<b>BMW</b>	<b>R 1150 GS (00 → 03)</b>	
 <b>KR694</b>	Specific rear rack for <b>MONOKEY</b> ® top-case <b>MONOKEY</b> ® plate included	
 <b>KL189</b>	Specific pannier holder for <b>MONOKEY</b> ®, RETRO FIT side-cases	
 <b>KD233S</b>	Specific screen, smoked 48,5 x 36,6 cm (H x W) <i>to be mounted instead of the original screen</i>	
<b>BMW</b>	<b>R 1150 R (01 → 06)</b>	
 <b>KR683</b>	Specific rear rack for <b>MONOKEY</b> ® top-case <b>MONOKEY</b> ® plate included / to be mounted only with the original side-case holder / maximum load allowed 6 Kg	
 <b>BF11K</b>	Specific flange for fitting the tank bags with TANKLOCK system	
<b>BMW</b>	<b>R 1150 RT (01)</b>	
 <b>K83</b>	Specific rear rack for <b>MONOKEY</b> ® top-case <i>to fit to the original rack</i>	
 <b>BF11K</b>	Specific flange for fitting the tank bags with TANKLOCK system	
<b>BMW</b>	<b>R 1150 RT (02 → 04)</b>	
 <b>K91</b>	Specific rear rack for <b>MONOKEY</b> ® top-case <i>to fit to the original rack / <b>MONOKEY</b>® plate included</i>	
 <b>BF11K</b>	Specific flange for fitting the tank bags with TANKLOCK system	
 <b>KD241ST</b>	Specific screen, transparent 48 x 51 cm (H x W) <i>to be mounted instead of the original screen</i>	













→ CODICE	DESCRIZIONE	PREZZO
<b>BMW</b>	<b>K 1200 GT (03 → 04)</b>	
 <b>K6800</b>	Specific rear rack for <b>MONOKEY</b> ® or <b>MONOLOCK</b> ® top-case <i>To be combined with the plate <b>MONOKEY</b>® K553N, or with the plate <b>MONOLOCK</b>® MKN/ it is compatible with the original side-case holder</i>	
<b>BMW</b>	<b>K 1200 R (05 → 08) / K 1300 R (09 → 16) <span style="background-color: #ff9900; color: white; padding: 2px;">NEW</span></b>	
 <b>KRA690</b>	Specific rear rack in aluminium for <b>MONOKEY</b> ® top-case <i>it can be fitted with the original side-case / maximum load allowed 6kg / it does not allow the assembly of the stop light kit or the remote control device on the case</i>	
 <b>KLXR691</b>	Specific rapid release side-case holder for K33 <b>MONOKEY</b> ® <b>SIDE</b> cases <i>you must move the indicators from their original position</i>	
 <b>BF11K</b>	Specific flange for fitting the tank bags with TANKLOCK system	
<b>BMW</b>	<b>K 1200 S (05 → 08) / K 1300 S (09 → 16)</b>	
 <b>KLR692</b>	Specific rapid release side-case holder for <b>MONOKEY</b> ®, RETRO FIT cases	
 <b>BF11K</b>	Specific flange for fitting the tank bags with TANKLOCK system	
<b>BMW</b>	<b>K 1200 GT / K 1300 GT (06 → 10)</b>	
 <b>KRA693</b>	Specific rear rack in aluminium for <b>MONOKEY</b> ® top-case <i>it can be fitted with the original side-case / maximum load allowed 6kg / it does not allow the assembly of the stop light kit or the remote control device on the case</i>	
 <b>BF11K</b>	Specific flange for fitting the tank bags with TANKLOCK system	
<b>BMW</b>	<b>K 1200 RS (00 → 04)</b>	
 <b>K6800</b>	Specific rear rack for <b>MONOKEY</b> ® or <b>MONOLOCK</b> ® top-case <i>To be combined with the plate <b>MONOKEY</b>® K553N, or with the plate <b>MONOLOCK</b>® MKN/ it is compatible with the original side-case holder</i>	
 <b>BF11K</b>	Specific flange for fitting the tank bags with TANKLOCK system	
<b>BMW</b>	<b>R 1200 GS (04 → 12)</b>	
 <b>KR684</b>	Specific rear rack for <b>MONOKEY</b> ® top-case <i>to fit to the original rack / maximum load allowed 6 Kg / <b>MONOKEY</b>® plate included / it is compatible with the original side-case</i>	
<b>KR689</b>	Specific rear rack for <b>MONOKEY</b> ® top-case <b>MONOKEY</b> ® plate included / in replacement of original rack / is compatible with the original side-case holder	
<b>KRA692</b>	Specific rear rack in aluminium for <b>MONOKEY</b> ® top-case <i>it can be fitted with the original side-case / maximum load allowed 6kg / it does not allow the assembly of the stop light kit or the remote control device on the case / compatible from '07 to '12</i>	
 <b>KL684</b>	Specific pannier holder for <b>MONOKEY</b> ®, RETRO FIT side-cases	
 <b>BF17K</b>	Specific flange for fitting the tank bags with TANKLOCK system <i>only for BMW R1200GS (04 &gt; 07)</i>	
<b>BF22K</b>	Specific flange for fitting the tank bags with TANKLOCK system <i>only for BMW R1200 GS (08 &gt; 12)</i>	
 <b>330DTK</b>	Specific screen, transparent 51,5 x 56,5 cm (H x W) <i>to be combined with the specific D330KITK fitting kit / 14,5 cm higher than the original / adjustable as the original</i>	
<b>D330KITK</b>	Specific fitting kit for 330DTK	
<b>KAF330</b>	Specific Airstream sliding wind-screen transparent. Maximum height 54 cm (12 cm of extension) width 54 cm <i>complete with specific fitting kit / to be mounted instead of the original screen</i>	
 <b>KN689</b>	Specific engine guard, grey <i>25 mm diameter steel tube / we recommend fitting by a qualified mechanic</i>	
<b>VARIOUS ACCESSORIES</b> <b>ES684K</b>	Specific support in aluminium and stainless steel to widen the surface support area of the original side stand <i>only for BMW R1200 GS (04 &gt; 05)</i>	
<b>ES5102K</b>	Specific support in aluminium and stainless steel to widen the surface support area of the original side stand <i>only for BMW R1200 GS (07 &gt; 12)</i>	
<b>01SKITK</b>	Specific kit to mounting the KS900A Smart Bar	



CODICE	DESCRIZIONE	PRICE
<b>BMW</b>	<b>R 1200 GS (13 → 18)</b>	
 <b>KR5108</b>	Specific rear rack for <b>MONOKEY</b> ® top-case <b>MONOKEY</b> ® plate included	
<b>KRA5108</b>	Specific rear rack in aluminium for <b>MONOKEY</b> ® top-case <i>maximum load allowed 6kg / it does not allow the assembly of the stop light kit or the remote control device on the case</i>	
 <b>KLR5108</b>	Specific rapid release side-case holder for <b>MONOKEY</b> ® cases <i>not compatible with the side-cases in aluminium KVE37 K-venture / you must move the indicators from their original position</i>	
<b>KTL5108PLRKIT</b>	Specific kit to install the KS250 Tool Box on KLR5108 <i>to be combined with KS250 and KLR5108 / you have to mount it on the left side of the motorcycle</i>	
 <b>BF11K</b>	Specific flange for fitting the tank bags with TANKLOCK system	
 <b>5108DK</b>	Specific screen smoked 43,5 x 43 cm (H x W) <i>compatible from 2013 to 2015 / to be combined with the specific D5108KITK fitting kit / 5 cm higher than the original R1200G and size equal to that of the bike R1200GS Adventure</i>	
<b>5108DTK</b>	Specific screen, transparent 55 x 44,5 cm (H x W) <i>compatible from 2013 to 2015 / 17 cm higher than original / to be combined with the specific D5108KITK fitting kit</i>	
<b>5124DTK</b>	Specific screen, transparent 53,5 x 45 cm (H x W) <i>compatible from 2016 / to be combined with the specific D5108KITK fitting kit / 15 cm higher than the original</i>	
<b>5124DK</b>	Specific screen, smoked 43,5 x 43 cm (H x W) <i>compatible from 2016 / to be combined with the specific D5108KITK fitting kit / 5 cm higher than the original</i>	
<b>D5108KITK</b>	Strengthening kit for the 5108DTK, 5108DK, 5124DTK, 5124DK screen	
<b>KD5124B</b>	Specific low and sports screen smoked 35 x 45 cm (H x W) <i>compatible from 2016 / to be mounted instead of the original screen</i>	
 <b>KN5108OX</b>	Specific engine guard, stainless steel <i>to be combined with KN5108KIT from 2016 / 25 mm diameter steel tube / we recommend fitting by a qualified mechanic / stainless steel</i>	
<b>KN5108</b>	Specific engine guard <i>to be combined with KN5108KIT from 2016 / 25 mm diameter steel tube / we recommend fitting by a qualified mechanic / black colour</i>	
<b>KNH5114</b>	Specific engine guard <i>compatible from 2013 to 2016 / 25 mm diameter steel tube / we recommend fitting by a qualified mechanic / black colour / It protects the upper part of the radiators / compatible with KN5108OX - KN5108 / compatible with the original engine guard optional BMW.</i>	
<b>KNH5114OX</b>	Specific engine guard, stainless steel <i>compatible from 2013 to 2016 / 25 mm diameter steel tube / we recommend fitting by a qualified mechanic / stainless steel / It protects the upper part of the radiators / compatible with KN5108OX - KN5108 / compatible with the original engine guard optional BMW.</i>	
<b>KNH5124</b>	Specific engine guard, black <i>compatible from 2017 / 25 mm diameter steel tube / we recommend fitting by a qualified mechanic / it protects the upper part of the radiators</i>	
<b>KNH5124OX</b>	Specific engine guard, stainless steel <i>compatible from 2017 / 25 mm diameter steel tube / we recommend fitting by a qualified mechanic / it protects the upper part of the radiators</i>	
<b>KN5108KIT</b>	Specific kit to install the engine guards KN5108 / KN5108OX <i>compatible from 2016 / to be combined with KN5108, KN5108OX</i>	
<b>RP5112K</b>	Oil carter protector in Aluminium	
<b>PH5108K</b>	Para-cylinder specific anodized aluminium	
<b>KPR5108</b>	Stainless steel specific radiator guard black painted	
<b>VARIOUS ACCESSORIES</b>	<b>FG5108K</b>	Specific footguards in ABS
<b>EH5108K</b>	Plexiglass extension for original hands protector, smoked	
<b>ES5108K</b>	Specific support in aluminium and stainless steel to widen the surface support area of the original side stand <i>it is not compatible with the version of the motorcycle equipped with lowered suspension</i>	
<b>01SKITK</b>	Specific kit to mounting the KS900A Smart Bar	
<b>BMW</b>	<b>R 1200 GS ADVENTURE (06 → 13)</b>	
 <b>KRA5102</b>	Specific rear rack in aluminium for <b>MONOKEY</b> ® top-case <i>it can be fitted with the original side-case / maximum load allowed 6kg / it does not allow the assembly of the stop light kit or the remote control device on the case</i>	
 <b>BF22K</b>	Specific flange for fitting the tank bags with TANKLOCK system <i>only for BMW R1200 GS Adventure (09 &gt; 13)</i>	
<b>VARIOUS ACCESSORIES</b>	<b>ES5102K</b>	Specific support in aluminium and stainless steel to widen the surface support area of the original side stand <i>only for BMW R1200 GS Adventure (07 &gt; 13)</i>
<b>01SKITK</b>	Specific kit to mounting the KS900A Smart Bar	



	CODICE	DESCRIZIONE	PREZZO
<b>BMW</b>		<b>R 1200 GS ADVENTURE (14 → 18)</b>	
	<b>KRA5112</b>	Specific rear rack in aluminium for <b>MONOKEY</b> ® top-case <i>maximum load allowed 6kg / it does not allow the assembly of the stop light kit or the remote control device on the case</i>	
	<b>KLR5108</b>	Specific rapid release side-case holder for <b>MONOKEY</b> ® cases <i>not compatible with the side-cases in aluminium KVE37 K-venture / you must move the indicators from their original position</i>	
	<b>KTL5108PLRKIT</b>	Specific kit to install the KS250 Tool Box on KLR5108 <i>to be combined with KS250 and KLR5108 / you have to mount it on the left side of the motorcycle</i>	
	<b>BF17K</b>	Specific flange for fitting the tank bags with TANKLOCK system	
	<b>5108DTK</b>	Specific screen, transparent 55 x 44.5 cm (H x W) <i>17 cm higher than original / to be combined with the specific D5108KITK fitting kit</i>	
	<b>5108DK</b>	Specific screen smoked 43.5 x 43 cm (H x W) <i>to be combined with the specific D5108KITK fitting kit / 5 cm higher than the original R1200G Adventure</i>	
	<b>5124DTK</b>	Specific screen, transparent 53,5 x 45 cm (H x W) <i>compatible from 2016 / to be combined with the specific D5108KITK fitting kit / 15 cm higher than the original</i>	
	<b>5124DK</b>	Specific screen, smoked 43,5 x 43 cm (H x W) <i>compatible from 2016 / to be combined with the specific D5108KITK fitting kit / 5 cm higher than the original</i>	
	<b>D5108KITK</b>	Strengthening kit for the 5108DTK, 5108DK, 5124DTK, 5124DK screen	
	<b>KD5124B</b>	Specific low and sports screen smoked 35 x 45 cm (H x W) <i>compatible from 2016 / to be mounted instead of the original screen</i>	
<b>VARIOUS ACCESSORIES</b>	<b>EH5108K</b>	Plexiglass extension for original hands protector, smoked	
	<b>KNH51120X</b>	Specific engine guard, stainless steel <i>25 mm diameter steel tube / we recommend fitting by a qualified mechanic / mount only in conjunction with the BMW engine guard</i>	
	<b>RP5112K</b>	Oil carter protector in Aluminium	
<b>VARIOUS ACCESSORIES</b>	<b>LP5112K</b>	Specific protection in steel and anodized aluminium for original spotlights <i>To be mounted only with the original optional spotlights</i>	
	<b>KPR5108</b>	Stainless steel specific radiator guard black painted	
<b>VARIOUS ACCESSORIES</b>	<b>FG5108K</b>	Specific footguards in ABS	
	<b>ES5112K</b>	Specific support in aluminium and stainless steel to widen the surface support area of the original side stand <i>it is not compatible with the version of the motorcycle equipped with lowered suspension</i>	
	<b>01SKITK</b>	Specific kit to mounting the KS900A Smart Bar	
<b>BMW</b>		<b>R 1200 R (06 → 10)</b>	
	<b>KZ688</b>	Specific rear rack for <b>MONOKEY</b> ® or <b>MONOLOCK</b> ® top-case <i>to be combined with the MONOKEY® KM5, KM7, KM8A, KM8B, KM9A or KM9B plate, or with the MONOLOCK® KM5M or KM6M plate / if combined with KM8A, KM8B, KM9A, KM9B it does not allow the assembly of the stop light kit or the remote control device on the case / it is not compatible with the original side-case holders / fitting kit included</i>	
	<b>147AK</b>	Specific screen, transparent 49,5 x 46 cm (H x W) <i>to be combined with the specific A147AK fitting kit</i>	
	<b>A147AK</b>	Specific fitting kit for 147AK	
<b>BMW</b>		<b>R 1200 R (11 → 14)</b>	
	<b>KR5100M</b>	Specific rear rack for <b>MONOLOCK</b> ® top-case <b>MONOLOCK</b> ® plate included	
	<b>BF22K</b>	Specific flange for fitting the tank bags with TANKLOCK system	
	<b>147AK</b>	Specific screen, transparent 49,5 x 46 cm (H x W) <i>to be combined with the specific A5100AK fitting kit</i>	
	<b>A5100AK</b>	Specific fitting kit for 147AK	
<b>VARIOUS ACCESSORIES</b>	<b>04SKITK</b>	Specific kit to mounting the KS900A Smart Bar	

CODICE	DESCRIZIONE	PRICE
<b>BMW R 1200 R (15 → 18) <span style="background-color: orange; color: white; padding: 2px;">NEW</span></b>		
 <b>KRA5117</b>	Specific rear rack in aluminium for <b>MONOKEY</b> ® top-case <i>maximum load allowed 6kg / it does not allow the assembly of the stop light kit or the remote control device on the case / It can only be mounted to the original rack (optional)</i>	
<b>KZ5117</b>	Specific rear rack for <b>MONOKEY</b> ® or <b>MONOLOCK</b> ® top-case <i>to be combined with the MONOKEY® KM5, KM7, KM8A, KM8B, KM9A or KM9B plate, or with the MONOLOCK® KM5M or KM6M plate / if combined with KM8A, KM8B, KM9A, KM9B it does not allow the assembly of the stop light kit or the remote control device on the case / it is not compatible with the original sidecase holder</i>	
 <b>KLXR5117</b>	Specific rapid release side-case holder for K33 <b>MONOKEY</b> ® <b>SIDE</b> cases	
 <b>BF11K</b>	Specific flange for fitting the tank bags with TANKLOCK system	
 <b>147AK</b>	Specific screen, transparent 49,5 x 46 cm (H x W) <i>to be combined with the specific A5117AK fitting kit</i>	
<b>A5117AK</b>	Specific fitting kit for 147AK	
 <b>KN5108</b>	Specific engine guard <i>to be combined with KN5108KIT / 25 mm diameter steel tube / we recommend fitting by a qualified mechanic / black colour</i>	
<b>KN5108OX</b>	Specific engine guard, stainless steel <i>to be combined with KN5108KIT / 25 mm diameter steel tube / we recommend fitting by a qualified mechanic / stainless steel</i>	
<b>RP5112K</b>	Oil carter protector in Aluminium	
<b>KN5108KIT</b>	Specific kit to install the engine guards KN5108 / KN5108OX <i>to be combined with KN5108, KN5108OX</i>	
 <b>RP5117KITK</b>	Specific kit to install the RP5112K	
 <b>PH5108K</b>	Para-cylinder specific anodized aluminium	
 <b>KHP5117</b>	 Specific hands protector in ABS	
<b>KHP5129</b>	Specific hands protector in ABS	
<b>01SKITK</b>	Specific kit to mounting the KS900A Smart Bar	
<b>BMW R 1200 RS (15 → 18)</b>		
 <b>KRA5117</b>	Specific rear rack in aluminium for <b>MONOKEY</b> ® top-case <i>maximum load allowed 6kg / it does not allow the assembly of the stop light kit or the remote control device on the case / It can only be mounted to the original rack (optional)</i>	
<b>KZ5117</b>	Specific rear rack for <b>MONOKEY</b> ® or <b>MONOLOCK</b> ® top-case <i>to be combined with the MONOKEY® KM5, KM7, KM8A, KM8B, KM9A or KM9B plate, or with the MONOLOCK® KM5M or KM6M plate / if combined with KM8A, KM8B, KM9A, KM9B it does not allow the assembly of the stop light kit or the remote control device on the case / it is not compatible with the original sidecase holder</i>	
 <b>KLXR5117</b>	Specific rapid release side-case holder for K33 <b>MONOKEY</b> ® <b>SIDE</b> cases	
 <b>BF11K</b>	Specific flange for fitting the tank bags with TANKLOCK system	
 <b>KD5120ST</b>	Specific screen, transparent, 56,5 x 47 cm (H x W) <i>to be mounted instead of the original screen / 19,5 cm higher than the original</i>	
 <b>KN5108</b>	Specific engine guard <i>to be combined with KN5108KIT / 25 mm diameter steel tube / we recommend fitting by a qualified mechanic / black colour</i>	
<b>KN5108OX</b>	Specific engine guard, stainless steel <i>to be combined with KN5108KIT / 25 mm diameter steel tube / we recommend fitting by a qualified mechanic / stainless steel</i>	
<b>RP5112K</b>	Oil carter protector in Aluminium <i>to be combined with RP5117KITK /</i>	
<b>KN5108KIT</b>	Specific kit to install the engine guards KN5108 / KN5108OX <i>to be combined with KN5108, KN5108OX</i>	
 <b>RP5117KITK</b>	Specific kit to install the RP5112K	
 <b>PH5108K</b>	Para-cylinder specific anodized aluminium	
 <b>01SKITK</b>	Specific kit to mounting the KS900A Smart Bar	

→	CODICE	DESCRIZIONE	PREZZO
<b>BMW</b>	<b>R 1200 RT (05 → 13)</b>		
	<b>KRA5116</b>	Specific rear rack in aluminium for <b>MONOKEY®</b> top-case <i>maximum load allowed 6kg / it does not allow the assembly of the stop light kit or the remote control device on the case</i>	
	<b>K93</b>	Specific rear rack for <b>MONOKEY®</b> top-case <b>MONOKEY®</b> plate included	
<b>VARIOUS ACCESSORIES</b>	<b>04SKITK</b>	Specific kit to mounting the KS900A Smart Bar	
<b>BMW</b>	<b>R 1200 RT (14 → 18)</b>		
	<b>KRA5113</b>	Specific rear rack in aluminium for <b>MONOKEY®</b> top-case <i>maximum load allowed 6kg / it does not allow the assembly of the stop light kit or the remote control device on the case</i>	
<b>VARIOUS ACCESSORIES</b>	<b>ES5113K</b>	Specific support in aluminium and stainless steel to widen the surface support area of the original side stand	
	<b>PH5108K</b>	Para-cylinder specific anodized aluminium	
	<b>BF17K</b>	Specific flange for fitting the tank bags with TANKLOCK system	
<b>VARIOUS ACCESSORIES</b>	<b>LS5113K</b>	Specific fitting kit to mount KS310 or KS322 spotlights	
<b>BMW</b>	<b>R 1200 S (06)</b>		
	<b>BF22K</b>	Specific flange for fitting the tank bags with TANKLOCK system	
<b>BMW</b>	<b>R NINE T 1200 (14 → 18)</b>		
	<b>BF22K</b>	Specific flange for fitting the tank bags with TANKLOCK system	
	<b>TE5115K</b>	Specific holder for soft side bags or for semi-rigid side bags (RA314) <i>you must move the indicators from their original position</i>	
	<b>TMT5115K</b>	Specific holder for one CR601U side bag <i>you must move the indicators from their original position</i>	
	<b>100ALK</b>	Grey anodized aluminium universal screen Race Cafe, for naked motorcycles 20,5 x 26,5 cm (H x W) <i>to be combined with the specific AL5115AK fitting kit</i>	
	<b>100ALBK</b>	Black anodized aluminium universal screen Race Cafe, for naked motorcycles 20,5 x 26,5 cm (H x W) <i>to be combined with the specific AL5115AK fitting kit</i>	
	<b>140AK</b>	Universal transparent screen 35 x 41cm (H x W) <i>to be combined with the specific AL5115AK fitting kit</i>	
	<b>140SK</b>	Universal smoked screen 35 x 41 cm (H x W) <i>to be combined with the specific AL5115AK fitting kit</i>	
	<b>AL5115AK</b>	Specific fitting kit for 100ALK, 100ALBK, 140AK, 140SK	
	<b>A5115AK</b>	Specific fitting kit A800NK	
<b>VARIOUS ACCESSORIES</b>	<b>LS5115K</b>	Specific fitting kit to mount KS310 or KS322 spotlights	
	<b>01SKITK</b>	Specific kit to mounting the KS900A Smart Bar	
<b>BMW</b>	<b>R 1250 GS (19) <span style="background-color: orange; color: white; padding: 2px;">NEW</span></b>		
	<b>KR5108</b>	Specific rear rack for <b>MONOKEY®</b> top-case <b>MONOKEY®</b> plate included	
	<b>KRA5108</b>	Specific rear rack in aluminium for <b>MONOKEY®</b> top-case <i>maximum load allowed 6kg / it does not allow the assembly of the stop light kit or the remote control device on the case</i>	
	<b>KLR5108</b>	Specific rapid release side-case holder for <b>MONOKEY®</b> cases <i>not compatible with the side-cases in aluminium KVE37 K-venture / you must move the indicators from their original position</i>	
	<b>KTL5108PLRKIT</b>	Specific kit to install the KS250 Tool Box on KLR5108 <i>to be combined with KS250 and KLR5108 / you have to mount it on the left side of the motorcycle</i>	
	<b>BF11K</b>	Specific flange for fitting the tank bags with TANKLOCK system	
	<b>5124DTK</b>	Specific screen, transparent 53,5 x 45 cm (H x W) <i>to be combined with the specific D5128KITK fitting kit / 15 cm higher than the original</i>	
	<b>5124DK</b>	Specific screen, smoked 43,5 x 43 cm (H x W) <i>to be combined with the specific D5128KITK fitting kit / 5 cm higher than the original</i>	

CODICE	DESCRIZIONE	PRICE
D5128KITK	Strengthening kit for the 5124DTK, 5124DK screen	
KD5124B	Specific low and sports screen smoked 35 x 45 cm (H x W) <i>to be mounted instead of the original screen</i>	
 KNH5124	Specific engine guard, black <i>25 mm diameter steel tube / we recommend fitting by a qualified mechanic / it protects the upper part of the radiators</i>	
KNH51240X	Specific engine guard, stainless steel <i>25 mm diameter steel tube / we recommend fitting by a qualified mechanic / it protects the upper part of the radiators</i>	
KN5128	Specific engine guard, black <i>25 mm diameter steel tube / we recommend fitting by a qualified mechanic</i>	
KPR5108	Stainless steel specific radiator guard black painted	
<b>VARIOUS ACCESSORIES</b> FG5108K	Specific footguards in ABS	
EH5108K	Plexiglass extension for original hands protector, smoked	
ES5108K	Specific support in aluminium and stainless steel to widen the surface support area of the original side stand <i>it is not compatible with the version of the motorcycle equipped with lowered suspension</i>	
01SKITK	Specific kit to mounting the KS900A Smart Bar	

### BMW R NINE T SCRAMBLER (16 → 18)

 BF22K	Specific flange for fitting the tank bags with TANKLOCK system
 TMT5115K	Specific holder for one CR601U side bag <i>you must move the indicators from their original position</i>
<b>VARIOUS ACCESSORIES</b> 01SKITK	Specific kit to mounting the KS900A Smart Bar

### BMW K 1600 GT (11 → 18)

 KRA5116	Specific rear rack in aluminium for <b>MONOKEY</b> ® top-case <i>maximum load allowed 6kg / it does not allow the assembly of the stop light kit or the remote control device on the case</i>
--	--





## CAGIVA

















### CAGIVA MITO 125





















 BF05K	Specific flange for fitting the tank bags with TANKLOCK system
--	--



















## DUCATI

### DUCATI SCRAMBLER 400 (16 → 18)



 KL7407	Specific pannier holder for <b>MONOKEY</b> ® side-cases <i>you can only mount cases MONOKEY® K22 / to ensure the best visibility of the rear indicators mounted with the cases, you need to relocate them by using kit IN7407KIT</i>
 7407AK	Specific screen, transparent 48 x 43,5 cm (H x W) <i>to be combined with the specific A7407A fitting kit</i>
7407ASK	Specific screen, transparent with "78" serigraphy, 48 x 43,5 cm (H x W) <i>to be combined with the specific A7407A fitting kit</i>
 A7407AK	Specific fitting kit for 7407AK, 7407ASK
 KN7407	Specific engine guard, black <i>25 mm diameter steel tube / we recommend fitting by a qualified mechanic / not compatible with the oil carter protector RP7407K</i>

→	CODICE	DESCRIZIONE	PREZZO
<b>DUCATI MULTISTRADA 620 / MULTISTRADA 1000 DS (03 → 05)</b>			
	<b>KR310</b>	Specific rear rack for <b>MONOKEY</b> ® top-case <b>MONOKEY</b> ® plate included / maximum load allowed 10 Kg	
<b>DUCATI MONSTER 695</b>			
	<b>03SKITK</b>	Specific kit to mounting the KS900A Smart Bar	
<b>DUCATI MONSTER 696 / 796 / 1100 (08 → 14)</b>			
	<b>KZ780</b>	Specific rear rack for <b>MONOKEY</b> ® or <b>MONOLOCK</b> ® top-case to be combined with the <b>MONOKEY</b> ® KM5, KM7, KM8A, KM8B, KM9A or KM9B plate, or with the <b>MONOLOCK</b> ® KM5M or KM6M plate / if combined with KM8A, KM8B, KM9A, KM9B it does not allow the assembly of the stop light kit or the remote control device on the case / maximum load allowed 6 kg	
	<b>TK681</b>	Specific holder for soft side bags	
	<b>7400KITK</b>	Specific kit to install the TE7400K and the TK681 without the specific rear rack	
	<b>BF09K</b>	Specific flange for fitting the tank bags with TANKLOCK system	
	<b>05SKITK</b>	Specific kit to mounting the KS900A Smart Bar	
<b>DUCATI HYPERMOTARD 796 / 1100 (12 → 14)</b>			
	<b>03SKITK</b>	Specific kit to mounting the KS900A Smart Bar	
<b>DUCATI MONSTER S2R / S4R / S4RS 800 / 1000 (04 → 08)</b>			
	<b>TK680</b>	Specific holder for soft side bags	
	<b>BF08K</b>	Specific flange for fitting the tank bags with TANKLOCK system	
	<b>03SKITK</b>	Specific kit to mounting the KS900A Smart Bar	
<b>DUCATI SCRAMBLER ICON 800 (15 → 18)</b>			
	<b>KL7407</b>	Specific pannier holder for <b>MONOKEY</b> ® side-cases you can only mount cases <b>MONOKEY</b> ® K22 / you must move the indicators from their original position	
	<b>7407AK</b>	Specific screen, transparent 48 x 43,5 cm (H x W) to be combined with the specific A7407A fitting kit	
	<b>7407ASK</b>	Specific screen, transparent with "78" serigraphy, 48 x 43,5 cm (H x W) to be combined with the specific A7407A fitting kit	
	<b>A7407AK</b>	Specific fitting kit for 7407AK, 7407ASK	
	<b>KN7407</b>	Specific engine guard, black 25 mm diameter steel tube / we recommend fitting by a qualified mechanic / not compatible with the oil carter protector RP7407K	
	<b>RP7407K</b>	Oil carter protector in Aluminium not compatible with the KN7407	
	<b>KPR7407</b>	Stainless steel specific radiator guard black painted	
<b>DUCATI HYPERSTRADA 821 (13 → 16)</b>			
	<b>KRA7403</b>	Specific rear rack in aluminium for <b>MONOKEY</b> ® top-case maximum load allowed 6kg / it does not allow the assembly of the stop light kit or the remote control device on the case	
	<b>03SKITK</b>	Specific kit to mounting the KS900A Smart Bar	
<b>DUCATI 848 / 1098 / 1198 (07 → 12)</b>			
	<b>BF08K</b>	Specific flange for fitting the tank bags with TANKLOCK system	

CODICE	DESCRIZIONE	PRICE
<b>DUCATI STREETFIGHTER 848 / 1098 (09 → 15)</b>		
 <b>247NK</b>	Specific screen, black 29 x 28,5 cm (H x W) <i>to be combined with the specific A781AK fitting kit</i>	
 <b>04SKITK</b>	Specific kit to mounting the KS900A Smart Bar	
<b>DUCATI ST2 / ST4 900 (97 → 01)</b>		
 <b>K6750</b>	Specific rear rack for <b>MONOKEY</b> ® or <b>MONOLOCK</b> ® top-case <i>To be combined with the plate <b>MONOKEY</b>® K553N, or with the plate <b>MONOLOCK</b>® MKN/ it cannot be mounted with the original side-case holder</i>	
 <b>BF08K</b>	Specific flange for fitting the tank bags with TANKLOCK system	
<b>DUCATI HYPERMOTARD 939 (16 → 18)</b>		
 <b>TST7409K</b> ↘	Specific holder for soft side bags	
 <b>KPR7409</b>	Stainless steel specific radiator guard black painted	
 <b>03SKITK</b>	Specific kit to mounting the KS900A Smart Bar <i>also for SP version</i>	
<b>DUCATI HYPERSTRADA 939 (16)</b>		
 <b>KRA7403</b>	Specific rear rack in aluminium for <b>MONOKEY</b> ® top-case <i>maximum load allowed 6kg / it does not allow the assembly of the stop light kit or the remote control device on the case</i>	
 <b>KL7403</b>	Specific pannier holder for <b>MONOKEY</b> ® side-cases <i>you can only mount cases <b>MONOKEY</b>® K22</i>	
 <b>KPR7409</b>	Stainless steel specific radiator guard black painted	
 <b>03SKITK</b>	Specific kit to mounting the KS900A Smart Bar	
<b>DUCATI SUPERSPORT 939 (17 → 18)</b>		
 <b>KD7410S</b>	Specific screen, smoked <i>to be mounted instead of the original screen</i>	
<b>DUCATI MULTISTRADA 950 (17 → 18)</b>		
 <b>BF11K</b>	Specific flange for fitting the tank bags with TANKLOCK system	
 <b>KD7406ST</b>	Specific screen, transparent 59 x 43 cm (H x W) <i>to be mounted instead of the original screen / 7 cm higher than the original</i>	
<b>KD7406S</b>	Specific screen, smoked <i>to be mounted instead of the original screen</i>	
 <b>KN7406B</b>	Specific engine guard, black <i>25 mm diameter steel tube / we recommend fitting by a qualified mechanic</i>	
<b>KPR7408</b>	Specific protection for water and oil radiators, made from black painted stainless steel	
 <b>KFB7408</b>	Fairing upper bracket to be mounted behind the windshield to install KS920M, KS920L and GPS-Smartphone holder <i>For KS920M, KS920L, KS952B, KS953B, KS954B, KS955B, KS956B, KS957B</i>	
<b>04SKITK</b>	Specific kit to mounting the KS900A Smart Bar	
<b>DUCATI ST3 1000 (04 → 08)</b>		
 <b>K6750</b>	Specific rear rack for <b>MONOKEY</b> ® or <b>MONOLOCK</b> ® top-case <i>To be combined with the plate <b>MONOKEY</b>® K553N, or with the plate <b>MONOLOCK</b>® MKN/ it cannot be mounted with the original side-case holder</i>	
<b>DUCATI MONSTER 1100 EVO (11 → 12)</b>		
 <b>KZ780</b>	Specific rear rack for <b>MONOKEY</b> ® or <b>MONOLOCK</b> ® top-case <i>to be combined with the <b>MONOKEY</b>® KM5, KM7, KM8A, KM8B, KM9A or KM9B plate, or with the <b>MONOLOCK</b>® KM5M or KM6M plate / if combined with KM8A, KM8B, KM9A, KM9B it does not allow the assembly of the stop light kit or the remote control device on the case / maximum load allowed 6 kg</i>	
 <b>7400KITK</b>	Specific kit to install the TE7400K and the TK681 without the specific rear rack	
 <b>BF09K</b>	Specific flange for fitting the tank bags with TANKLOCK system	

→ CODICE	DESCRIZIONE	PREZZO
<b>DUCATI 1199 PANIGALE (12 → 13)</b>		
 <b>KD7402S</b>	Specific screen, smoked 35 x 27 cm (H x W) <i>to be mounted instead of the original screen</i>	
<b>DUCATI MONSTER 1200 (14 → 18)</b>		
 <b>BF08K</b>	Specific flange for fitting the tank bags with TANKLOCK system	
 <b>KA7404</b>	Specific screen, smoked 28,5 x 36 cm (H x W) <i>compatible from 14 to 16 / Complete with fitting kit</i>	
 <b>05SKITK</b>	Specific kit to mounting the KS900A Smart Bar	
<b>DUCATI DIAVEL 1200 (11 → 18)</b>		
 <b>TE7405K</b>	Specific holder for soft side bags or for semi-rigid side bags (RA314) <i>By mounting the side bags, the indicators are covered laterally and therefore the 80° side lighting cannot be guaranteed</i>	
<b>DUCATI MULTISTRADA 1200 (10 → 12)</b>		
 <b>KR312</b>	Specific rear rack for <b>MONOKEY®</b> top-case <b>MONOKEY®</b> plate included / is compatible with the original side-case holder	
<b>KRA7401</b>	Specific rear rack in aluminium for <b>MONOKEY®</b> top-case <i>maximum load allowed 6kg / it does not allow the assembly of the stop light kit or the remote control device on the case</i>	
 <b>BF11K</b>	Specific flange for fitting the tank bags with TANKLOCK system	
 <b>KN7401</b>	Specific engine guard <i>only for years 2011-2012 / 25 mm diameter steel tube / we recommend fitting by a qualified mechanic / black colour</i>	
 <b>ES7401K</b>	Specific support in aluminium and stainless steel to widen the surface support area of the original side stand	
<b>DUCATI MULTISTRADA 1200 (13 → 14)</b>		
 <b>KR312</b>	Specific rear rack for <b>MONOKEY®</b> top-case <b>MONOKEY®</b> plate included / is compatible with the original side-case holder	
<b>KRA7401</b>	Specific rear rack in aluminium for <b>MONOKEY®</b> top-case <i>maximum load allowed 6kg / it does not allow the assembly of the stop light kit or the remote control device on the case</i>	
 <b>BF11K</b>	Specific flange for fitting the tank bags with TANKLOCK system	
 <b>KD7401NO</b> ↘	Specific screen, matt black 35 x 28 cm (H x W) <i>to be mounted instead of the original screen</i>	
 <b>KN7401</b>	Specific engine guard <i>25 mm diameter steel tube / we recommend fitting by a qualified mechanic / black colour</i>	
 <b>ES7401K</b>	Specific support in aluminium and stainless steel to widen the surface support area of the original side stand	
<b>DUCATI MULTISTRADA 1200 (15 → 18)</b>		
 <b>BF11K</b>	Specific flange for fitting the tank bags with TANKLOCK system	
 <b>KD7406ST</b>	Specific screen, transparent 59 x 43 cm (H x W) <i>to be mounted instead of the original screen / 7 cm higher than the original</i>	
<b>KD7406S</b>	Specific screen, smoked <i>to be mounted instead of the original screen</i>	
 <b>KN7406</b>	Specific engine guard, black <i>25 mm diameter steel tube / we recommend fitting by a qualified mechanic</i>	
<b>KN7406B</b>	Specific engine guard, black <i>25 mm diameter steel tube / we recommend fitting by a qualified mechanic</i>	
<b>KPR7406</b>	Stainless steel specific radiator guard black painted	
 <b>ES7401K</b>	Specific support in aluminium and stainless steel to widen the surface support area of the original side stand <i>not compatible with the original central stand</i>	
<b>KFB7408</b>	Fairing upper bracket to be mounted behind the windshield to install KS920M, KS920L and GPS-Smartphone holder <i>For KS920M, KS920L, KS952B, KS953B, KS954B, KS955B, KS956B, KS957B</i>	
<b>04SKITK</b>	Specific kit to mounting the KS900A Smart Bar	





CODICE	DESCRIZIONE	PRICE
<b>DUCATI MULTISTRADA ENDURO 1200 (16 → 18)</b>		
 <b>BF11K</b>	Specific flange for fitting the tank bags with TANKLOCK system	
 <b>KN7408</b>	Specific engine guard, black <i>25 mm diameter steel tube / we recommend fitting by a qualified mechanic</i>	
<b>KPR7408</b>	Specific protection for water and oil radiators, made from black painted stainless steel	
<b>VARIOUS ACCESSORIES</b> <b>KFB7408</b>	Fairing upper bracket to be mounted behind the windshield to install KS920M, KS920L and GPS-Smartphone holder <i>For KS920M, KS920L, KS952B, KS953B, KS954B, KS955B, KS956B, KS957B</i>	
<b>04SKITK</b>	Specific kit to mounting the KS900A Smart Bar	
<b>DUCATI MULTISTRADA 1260 (18) <span style="color: orange;">NEW</span></b>		
 <b>BF11K</b>	Specific flange for fitting the tank bags with TANKLOCK system	
 <b>KD7406ST</b>	Specific screen, transparent 59 x 43 cm (H x W) <i>to be mounted instead of the original screen / 7 cm higher than the original</i>	
<b>KD7406S</b>	Specific screen, smoked <i>to be mounted instead of the original screen</i>	
 <b>KN7406B</b>	Specific engine guard, black <i>25 mm diameter steel tube / we recommend fitting by a qualified mechanic</i>	
<b>KPR7408</b>	Specific protection for water and oil radiators, made from black painted stainless steel	
<b>VARIOUS ACCESSORIES</b> <b>ES7411K</b>	Specific support in aluminium and stainless steel to widen the surface support area of the original side stand	
<b>KFB7408</b>	Fairing upper bracket to be mounted behind the windshield to install KS920M, KS920L and GPS-Smartphone holder <i>For KS920M, KS920L, KS952B, KS953B, KS954B, KS955B, KS956B, KS957B</i>	
<b>GILERA</b>		
<b>GILERA RUNNER 50-125-200 (06 → 15)</b>		
 <b>KR126</b>	Specific rear rack for <b>MONOLOCK®</b> top-case <i>it is necessary to puncture the housing behind the saddle / maximum load allowed 3 Kg / to be combined with the plate already included in the <b>MONOLOCK®</b> top-case</i>	
<b>GILERA NEXUS 125 - 250 - 300 - 500 (06 → 14)</b>		
 <b>K682</b>	Specific rear rack for <b>MONOKEY®</b> top-case <b>MONOKEY®</b> plate included / <i>it is necessary to puncture the housing behind the saddle / maximum load allowed 6Kg</i>	
<b>K682M</b>	Specific rear rack for <b>MONOLOCK®</b> top-case <b>MONOLOCK®</b> plate included / <i>it is necessary to puncture the housing behind the saddle / maximum load allowed 6Kg</i>	
 <b>KD351ST</b>	Specific screen, transparent 65 x 50 cm (H x W) <i>to be mounted instead of the original screen / 24 cm higher than the original</i>	
<b>GILERA FUOCO 500 (07 → 14)</b>		
 <b>KE7100</b>	Specific rear rack for <b>MONOLOCK®</b> top-case <i>to be combined with the plate already included in the <b>MONOLOCK®</b> top-case</i>	
<b>K710</b>	Specific rear rack for <b>MONOKEY®</b> top-case <b>MONOKEY®</b> plate included	
 <b>340DK</b>	Specific screen, smoked 64,5 x 54,5 cm (H x W) <i>to be combined with the specific D340KITK fitting kit</i>	
<b>D340KITK</b>	Specific fitting kit for 340DK	
<b>GILERA NEXUS 500 (05)</b>		
 <b>K682</b>	Specific rear rack for <b>MONOKEY®</b> top-case <b>MONOKEY®</b> plate included / <i>it is necessary to puncture the housing behind the saddle / maximum load allowed 6Kg</i>	
<b>K682M</b>	Specific rear rack for <b>MONOLOCK®</b> top-case <b>MONOLOCK®</b> plate included / <i>it is necessary to puncture the housing behind the saddle / maximum load allowed 6Kg</i>	

→ CODICE	DESCRIZIONE	PREZZO
-------------	-------------	--------

<b>GILERA</b>	<b>GP 800 (08 → 14)</b>	
 <b>KD352ST</b>	Specific screen, transparent 60 x 42 cm (H x W) <i>to be mounted instead of the original screen / 12 cm higher than the original</i>	



## HONDA





<b>HONDA</b>	<b>ZOOMER 50 (RUCKUS 50) (04 → 14)</b>	
 <b>105AK</b>	Specific screen, transparent 66 x 67 cm (H x W) <i>only available if article A303A is already fitted / With hand protectors</i>	
<b>128AK</b>	Specific screen, transparent 74 x 67 cm (H x W) <i>only available if article A303A is already fitted / 8 cm higher than 105AK</i>	



<b>HONDA</b>	<b>VISION 50-110 (11 → 18)</b>	
 <b>KR1153</b>	Specific rear rack for <b>MONOLOCK®</b> top-case <i>to be combined with the plate already included in the MONOLOCK® top-case</i>	
 <b>308AK</b>	Specific screen, transparent with serigraphy 52 x 66,5 cm (H x W) <i>to be combined with the specific A1153AK or A1106A fitting kit</i>	
<b>A1153AK</b>	Specific fitting kit for 308AK	













<b>HONDA</b>	<b>LEAD 110 (08 → 14)</b>	
 <b>314AK</b>	Specific screen, transparent 52 x 66,5 cm (H x W) <i>to be combined with the specific A314AK fitting kit / With hand protectors</i>	
<b>A314AK</b>	↘ Specific fitting kit for 314AK	

<b>HONDA</b>	<b>WAVE 110i (12 → 14)</b>	
 <b>A1114AK</b>	↘ Specific fitting kit for 1114A <i>only available if article 1114A is already fitted</i>	









<b>HONDA</b>	<b>CB 125F (15 → 18)</b>	
 <b>KR1142</b>	Specific rear rack for <b>MONOLOCK®</b> top-case <i>to be combined with the plate already included in the MONOLOCK® top-case / it is necessary to remove the original grab handle</i>	
 <b>KL1142</b>	Specific pannier holder for <b>MONOKEY®</b> side-cases <i>you can only mount cases MONOKEY® K22 / it can be mounted only with the specific rear rack KR1142</i>	
 <b>KN1142</b>	Specific engine guard, black <i>compatible from 15 to 16 / 25 mm diameter steel tube / we recommend fitting by a qualified mechanic</i>	











<b>HONDA</b>	<b>CB 125 R (18 → 19) <span style="background-color: #f47920; color: white; padding: 2px;">NEW</span></b>	
 <b>KR1164</b>	Specific rear rack for <b>MONOLOCK®</b> top-case <i>to be combined with the plate already included in the MONOLOCK® top-case</i>	
<b>KR1169</b>	Specific rear rack for <b>MONOLOCK®</b> top-case <i>to be combined with the plate already included in the MONOLOCK® top-case</i>	
 <b>BF41K</b>	Specific flange for fitting the tank bags with TANKLOCK system	
 <b>KA1164</b>	Specific screen, smoked 21 x 28 cm (H x W) <i>complete with specific fitting kit</i>	
 <b>KN1164</b>	Specific engine guard, black <i>25 mm diameter steel tube / we recommend fitting by a qualified mechanic</i>	
<b>VARIOUS ACCESSORIES</b> <b>01SKITK</b>	Specific kit to mounting the KS900A Smart Bar	













<b>HONDA</b>	<b>CBF 125 (09 → 14)</b>	
 <b>KR1570</b>	Specific rear rack for <b>MONOLOCK®</b> top-case <i>maximum load allowed 6 kg / to be combined with the plate already included in the MONOLOCK® top-case</i>	
 <b>D317KITK</b>	Specific fitting kit for 317DT <i>only available if article 317DT is already fitted</i>	
 <b>KN1142</b>	Specific engine guard, black <i>25 mm diameter steel tube / we recommend fitting by a qualified mechanic</i>	















CODICE	DESCRIZIONE	PRICE
<b>HONDA CBR 125 (05 → 10)</b>		
 <b>KZ262</b>	Specific rear rack for <b>MONOLOCK®</b> top-case <i>we recommend mounting smaller cases <b>MONOLOCK®</b> in conjunction with M5M or M6M plate</i>	
<b>HONDA CBR 125 R (11 → 17)</b>		
 <b>KR1103</b>	Specific rear rack for <b>MONOLOCK®</b> top-case <i>maximum load allowed 6 kg / to be combined with the plate already included in the <b>MONOLOCK®</b> top-case</i>	
<b>HONDA FORZA 125 ABS (15 → 18)</b>		
 <b>KR1140</b> ↘	Specific rear rack for <b>MONOLOCK®</b> or <b>MONOKEY®</b> top-case <i>to be combined with the <b>MONOKEY®</b> KM5, KM7 plate, or with the <b>MONOLOCK®</b> KM5M or KM6M plate, or with the plate already included in the <b>MONOLOCK®</b> top-case / maximum load allowed 6 kg</i>	
<b>KR1166</b>	Specific rear rack for <b>MONOLOCK®</b> or <b>MONOKEY®</b> top-case <i>to be combined with the <b>MONOKEY®</b> KM5, KM8A, KM8B, KM9A or KM9B plate, or with the <b>MONOLOCK®</b> KM5M or KM6M plate or with the plate already included in the <b>MONOLOCK®</b> top-cases / if combined with KM8A, KM8B, KM9A, KM9B it does not allow the assembly of the stop light kit or the remote control device on the case / maximum load allowed 6 kg</i>	
 <b>KD1140ST</b>	Specific screen, transparent, 70,5 x 63 cm (H x W) <i>not compatible with models 2018 having electrically adjustable screen / to be mounted instead of the original screen / 23 cm higher than the original / The assembly does not allow you to adjust the height of the windshield</i>	
<b>KD1140S</b>	Specific screen, smoked 48,5 x 39 cm (H x W) <i>not compatible with models 2018 having electrically adjustable screen / to be mounted instead of the original screen / It does not compromise the possibility of adjusting the height of the windshield</i>	
<b>VARIOUS ACCESSORIES</b> <b>KTB1140</b> ↘	Specific backrest <i>it cannot be mounted if rack and case are installed</i>	
<b>KTB1166</b>	Specific backrest <i>it cannot be mounted if rack and case are installed</i>	
<b>HONDA SH MODE 125 (13 → 18)</b>		
 <b>KR1125</b>	Specific rear rack for <b>MONOLOCK®</b> top-case <i>to be combined with the plate already included in the <b>MONOLOCK®</b> top-case</i>	
 <b>1125AK</b>	Specific screen, transparent 43 x 46 cm (H x W) <i>to be combined with the specific A1125AK fitting kit</i>	
<b>A1125AK</b>	Specific fitting kit for 1125AK	
<b>HONDA XL 125 V VARADERO (01 → 06)</b>		
 <b>KE2170</b>	Specific rear rack for <b>MONOLOCK®</b> top-case <i>maximum load allowed 5 Kg / to be combined with the plate already included in the <b>MONOLOCK®</b> top-case</i>	
<b>K213</b>	Specific rear rack for <b>MONOKEY®</b> top-case <b>MONOKEY®</b> plate included	
 <b>KD215S</b>	Specific screen, smoked 49,9 x 33,2 cm (H x W) <i>to be mounted instead of the original screen</i>	
<b>VARIOUS ACCESSORIES</b> <b>03SKITK</b>	Specific kit to mounting the KS900A Smart Bar	
<b>HONDA XL 125 V VARADERO (07 → 14)</b>		
 <b>KE2170</b>	Specific rear rack for <b>MONOLOCK®</b> top-case <i>maximum load allowed 5 Kg / to be combined with the plate already included in the <b>MONOLOCK®</b> top-case</i>	
<b>K213</b>	Specific rear rack for <b>MONOKEY®</b> top-case <b>MONOKEY®</b> plate included	
 <b>KL202</b>	Specific pannier holder for <b>MONOKEY®</b> , RETRO FIT side-cases	
 <b>KD311S</b>	Specific screen, smoked 46 x 33 cm (H x W) <i>to be mounted instead of the original screen / 19 cm higher than original</i>	
<b>VARIOUS ACCESSORIES</b> <b>03SKITK</b>	Specific kit to mounting the KS900A Smart Bar	
<b>HONDA SUPER CUB C125 (18) <span style="background-color: orange; color: white; padding: 2px;">NEW</span></b>		
 <b>KR1168</b>	Specific rear rack for <b>MONOLOCK®</b> top-case <i>to be combined with the plate already included in the <b>MONOLOCK®</b> top-case</i>	
 <b>1168AK</b>	Specific screen, transparent 38,5 x 41,5 cm (H x W) <i>to be combined with the specific A1168AK fitting kit / it does not protect the hand area</i>	
<b>A1168AK</b>	Specific fitting kit for 1168AK	

CODICE	DESCRIZIONE	PREZZO
<b>HONDA @ 125-150 (04 → 08)</b>		
 <b>183AK</b>	Specific screen, transparent 67,9 x 66,5 cm (H x W) <i>to be combined with the specific A301A fitting kit</i>	
<b>HONDA @ 125-150 (00 → 03)</b>		
 <b>183AK</b>	Specific screen, transparent 67,9 x 66,5 cm (H x W) <i>only available if article A183A is already fitted</i>	
<b>HONDA DYLAN 125-150 (02 → 07)</b>		
 <b>102AK</b>	Specific screen, transparent 66 x 68 cm (H x W) <i>to be combined with the specific A185AK fitting kit / With hand protectors</i>	
<b>128AK</b>	Specific screen, transparent 74 x 67 cm (H x W) <i>to be combined with the specific A185AK fitting kit / 8 cm higher than 102AK</i>	
<b>A185AK</b>	Specific fitting kit for 128AK and 102AK	
<b>HONDA PANTHEON 125-150 (98 → 02)</b>		
 <b>KR140</b>	Specific rear rack for <b>MONOLOCK®</b> or <b>MONOKEY®</b> top-case <i>to be combined with the K636 MONOKEY® plate (sold separately), or with the plate already included in the MONOLOCK® top-cases</i>	
 <b>KD199ST</b>	Specific screen, transparent 49,9 x 72,5 cm (H x W) <i>to be mounted instead of the original screen</i>	
<b>KD202ST</b>	Specific screen, transparent 60 x 74,4 cm (H x W) <i>to be mounted instead of the original screen / 10 cm higher than KD199ST</i>	
<b>D199KITK</b>	Kit for a better anchorage of the spoilers: KD199ST and KD202ST	
<b>HONDA PANTHEON 125-150 (03 → 08)</b>		
 <b>KE2160</b>	Specific rear rack for <b>MONOLOCK®</b> top-case <i>to be combined with the plate already included in the MONOLOCK® top-case</i>	
 <b>KD219ST</b>	Specific screen, transparent 63 x 72,5 cm (H x W) <i>to be mounted instead of the original screen / With hand protectors</i>	
<b>HONDA PCX 125-150 (10 → 13)</b>		
 <b>KR1163</b>	Specific rear rack for <b>MONOLOCK®</b> top-case <i>to be combined with the plate already included in the MONOLOCK® top-case</i>	
 <b>323DTK</b>	Specific screen, transparent 82 x 58 cm (H x W) <i>to be combined with the specific D323KITK fitting kit / 41 cm higher than original</i>	
<b>D323KITK</b>	Specific fitting kit for 323DTK	
<b>KD322ST</b>	Specific screen, transparent, 59,5 x 44 cm (H x W) <i>to be mounted instead of the original screen / 18,5 cm higher than original</i>	
<b>KD322S</b>	Specific screen, smoked, 59,5 x 44 cm (H x W) <i>to be mounted instead of the original screen / 18,5 cm higher than original</i>	
<b>HONDA PCX 125-150 (14 → 17) / PCX 150 (18)</b>		
 <b>KR1163</b>	Specific rear rack for <b>MONOLOCK®</b> top-case <i>to be combined with the plate already included in the MONOLOCK® top-case</i>	
 <b>KD1136ST</b>	Specific screen, transparent 63,0 x 43,5 cm (H x W) <i>to be mounted instead of the original screen</i>	
<b>KD1130ST</b>	Specific screen, transparent 81.5 x 55 cm (H x W) <i>to be mounted instead of the original screen</i>	
<b>VARIOUS ACCESSORIES</b> <b>KTB1136</b>	Specific backrest <i>it cannot be mounted if rack and case are installed</i>	
<b>KTB1163</b>	Specific backrest <i>it cannot be mounted if rack and case are installed</i>	
<b>HONDA PCX 125 (18 → 19)</b>		
 <b>KR1163</b>	Specific rear rack for <b>MONOLOCK®</b> top-case <i>to be combined with the plate already included in the MONOLOCK® top-case</i>	
 <b>1163DTK</b>	Specific screen, transparent 85 x 63 cm (H x W) <i>to be combined with the specific D1163KITK fitting kit / 39 cm higher than the original</i>	
<b>1129DTK</b>	Specific screen, transparent 60,5 x 43,5 cm (H x W) <i>to be combined with the specific D1163KITK fitting kit / 14,5 cm higher than the original</i>	



CODICE	DESCRIZIONE	PRICE
1129DK	Specific screen, smoked 60,5 x 43,5 cm (H x W) <i>to be combined with the specific D1163KITK fitting kit / 14,5 cm higher than the original</i>	
D1163KITK	Specific fitting kit for 1163DTK, 1129DTK, 1129DK	
<b>VARIOUS ACCESSORIES</b> KTB1163	Specific backrest <i>it cannot be mounted if rack and case are installed</i>	
<b>HONDA SH 125-150 (01 → 04)</b>		
 186AK	Specific screen, transparent 58 x 68 cm (H x W) <i>to be combined with the specific A186AK fitting kit</i>	
A186AK	Specific fitting kit for 186AK	
You can fit a MONOLOCK® top-case using the universal plate included		
<b>HONDA SH 125I-150I (05 → 08)</b>		
 KE2190	Specific rear rack for <b>MONOLOCK®</b> top-case <i>to be combined with the plate already included in the MONOLOCK® top-case</i>	
 311AK	Specific screen, transparent 62 x 67,5 cm (H x W) <i>to be combined with the specific A311AK fitting kit / With hand protectors</i>	
313AK	Specific screen, transparent 55 x 66 cm (H x W) <i>to be combined with the specific A311AK fitting kit / With hand protectors</i>	
A311AK	Specific fitting kit for 311AK, 313AK	
<b>HONDA SH 125I-150I (09 → 12)</b>		
 KR1155	Specific rear rack for <b>MONOLOCK®</b> top-case <i>to be combined with the plate already included in the MONOLOCK® top-case</i>	
KE2270	Specific rear rack for <b>MONOLOCK®</b> top-case <i>to be combined with the plate already included in the MONOLOCK® top-case / maximum load allowed 3 kg</i>	
 311AK	Specific screen, transparent 62 x 67,5 cm (H x W) <i>to be combined with the specific A315AK fitting kit / with hand protectors</i>	
313AK	Specific screen, transparent 55 x 66 cm (H x W) <i>to be combined with the specific A315AK fitting kit / With hand protectors</i>	
A315AK	Specific fitting kit for 311AK and 313AK	
<b>HONDA SH 125I-150I ABS (12 → 16)</b>		
 KR1155	Specific rear rack for <b>MONOLOCK®</b> top-case <i>to be combined with the plate already included in the MONOLOCK® top-case</i>	
KE2270	Specific rear rack for <b>MONOLOCK®</b> top-case <i>to be combined with the plate already included in the MONOLOCK® top-case / maximum load allowed 3 kg</i>	
 KD1128BL	Specific BLUE LINE screen, to be fixed with original Honda fitting kit, 36,5 x 45 cm (H x W) <i>to be mounted instead of the original screen / the edge glows blue in the dark when illuminated by the cars' headlights</i>	
KD1128S	Specific screen smoked, to be fixed with original Honda fitting kit, 36,5 x 45 cm (H x W) <i>to be mounted instead of the original screen</i>	
1117AK	Specific screen, transparent 72 x 71 cm (H x W) <i>to be combined with the specific A1117AK fitting kit</i>	
1128AK	Specific wind-screen replacement to be fixed with original Honda fitting kit, 53 x 50 cm (H x W) <i>It does not protect the hand area</i>	
A1117AK	Kit di attacchi specifico per 1117AK <i>To mount the windshield, it is necessary to have the original pre-perforated Honda handlebar fairing which is also used to mount the original Honda windshield. If the handlebar fairing mounted to the motorcycle is not pre-perforated, it will be necessary to drill holes into it</i>	
<b>HONDA SH 125I-150I (17 → 18)</b>		
 KR1155	Specific rear rack for <b>MONOLOCK®</b> top-case <i>to be combined with the plate already included in the MONOLOCK® top-case</i>	
 KD1155ST	Specific screen, transparent, to be fixed with original Honda fitting kit, 51 x 49 cm (H x W) <i>it does not protect the hand area</i>	
KD1155S	Specific screen smoked, to be fixed with original Honda fitting kit, 36,5 x 45 cm (H x W)	
KD1155BL	Specific BLUE LINE screen to be fixed with original Honda fitting kit, 36,5 x 45 cm (H x W) <i>when illuminated by vehicle headlights in low light conditions, the edge glows blue in colour</i>	



CODICE	DESCRIZIONE	PREZZO
1117AK	Specific screen, transparent 72 x 71 cm (H x W) <i>to be combined with the specific A1155AK fitting kit</i>	
A1155AK	Specific fitting kit for 1117AK	
<b>HONDA S-WING 125-150 (07 → 12)</b>		
 KD312ST	Specific screen, transparent 89 x 54 cm (H x W) <i>to be mounted instead of the original screen</i>	
<b>HONDA FORZA 125-300 (19)</b>		
 KR1166	Specific rear rack for <b>MONOLOCK</b> ® or <b>MONOKEY</b> ® top-case <i>to be combined with the MONOKEY® KM5, KM8A, KM8B, KM9A or KM9B plate, or with the MONOLOCK® KM5M or KM6M plate or with the plate already included in the MONOLOCK® top-cases / if combined with KM8A, KM8B, KM9A, KM9B it does not allow the assembly of the stop light kit or the remote control device on the case / maximum load allowed 6 kg</i>	
 KD1166ST	Specific screen, transparent 58 x 44,5 cm (H x W) <i>to be mounted instead of the original screen / 11 cm higher than the original</i>	
DF1166K	Pair of protective transparent handle-bar wind deflectors <i>specific fitting kit included</i>	
<b>VARIOUS ACCESSORIES</b> KTB1166	Specific backrest <i>it cannot be mounted if rack and case are installed</i>	
<b>HONDA CBR 250 R (11 → 15)</b>		
 KR1103	Specific rear rack for <b>MONOLOCK</b> ® top-case <i>maximum load allowed 6 kg / to be combined with the plate already included in the MONOLOCK® top-case</i>	
<b>HONDA FORESIGHT 250 (97 → 08)</b>		
 KR140	Specific rear rack for <b>MONOLOCK</b> ® or <b>MONOKEY</b> ® top-case <i>to be combined with the K636 MONOKEY® plate (sold separately), or with the plate already included in the MONOLOCK® top-cases</i>	
 KD199ST	Specific screen, transparent 49,9 x 72,5 cm (H x W) <i>to be mounted instead of the original screen</i>	
KD202ST	Specific screen, transparent 60 x 74,4 cm (H x W) <i>to be mounted instead of the original screen / 10 cm higher than KD199ST</i>	
D199KITK	Kit for a better anchorage of the spoilers: KD199ST and KD202ST	
<b>HONDA FORZA 250 (05 → 07)</b>		
 K22	Specific rear rack for <b>MONOKEY</b> ® top-case <b>MONOKEY</b> ® plate included / in order to fix you must remove the original backrest	
K22M	Specific rear rack for <b>MONOLOCK</b> ® top-case <b>MONOLOCK</b> ® plate included / in order to fix you must remove the original backrest	
 KD306ST	Specific screen, transparent 73 x 61,5 cm (H x W) <i>to be mounted instead of the original screen / 34 cm higher than the original</i>	
<b>HONDA FORZA 250 X / EX (08 → 12)</b>		
 K226	Specific rear rack for <b>MONOKEY</b> ® top-case <b>MONOKEY</b> ® plate included / it is necessary to puncture the housing behind the saddle in arranged sections / maximum load allowed 6 Kg	
K226M	Specific rear rack for <b>MONOLOCK</b> ® top-case <b>MONOLOCK</b> ® plate included / it is necessary to puncture the housing behind the saddle in arranged sections / maximum load allowed 6 Kg	
 D315KITK	Specific fitting kit for 315DT <i>only available if article 315DT is already fitted</i>	
<b>HONDA CRF 250 L / CRF 250 RALLY (17 → 18)</b>		
 KR1159	Specific rear rack for <b>MONOLOCK</b> ® or <b>MONOKEY</b> ® top-case <i>to be combined with the K636 MONOKEY® plate (sold separately), or with the plate already included in the MONOLOCK® top-cases / maximum load allowed 6 kg</i>	
<b>HONDA FORZA 300 ABS (13 → 17)</b>		
 KR1123	Specific rear rack for <b>MONOKEY</b> ® top-case <i>maximum load allowed 6 kg / MONOKEY® plate included</i>	
KR1123MM	Specific rear rack for <b>MONOLOCK</b> ® top-case <b>MONOLOCK</b> ® plate with place for the "u" type padlock included	
 KD1123ST	Specific screen, transparent 73 x 59 cm (H x W) <i>to be mounted instead of the original screen / 21 cm higher than the original</i>	







CODICE	DESCRIZIONE	PRICE
<b>HONDA SH 300I (07 → 10)</b>		
 <b>KE2230</b>	Specific rear rack for <b>MONOLOCK®</b> top-case <i>to be combined with the plate already included in the <b>MONOLOCK®</b> top-case</i>	
 <b>307AK</b>	Specific screen, transparent with serigraphy 58,5 x 68 cm (H x W) <i>to be combined with the specific A307AK fitting kit</i>	
<b>308AK</b>	Specific screen, transparent with serigraphy 52 x 66,5 cm (H x W) <i>to be combined with the specific A307AK fitting kit</i>	
<b>A307AK</b>	Specific fitting kit for 307AK and 308AK <i>Black colour</i>	
<b>KAF308</b> ↘	Specific Airstream sliding wind-screen transparent. Maximum height 48 cm (12 cm of extension) width 67 cm <i>complete with specific fitting kit / to be mounted instead of the original screen</i>	
<b>HONDA SH 300I (11 → 14)</b>		
 <b>KE2230</b>	Specific rear rack for <b>MONOLOCK®</b> top-case <i>to be combined with the plate already included in the <b>MONOLOCK®</b> top-case</i>	
 <b>307AK</b>	Specific screen, transparent with serigraphy 58,5 x 68 cm (H x W) <i>to be combined with the specific A1100AK fitting kit</i>	
<b>A1100AK</b>	Specific fitting kit for 307AK and 308AK	
<b>308AK</b>	Specific screen, transparent with serigraphy 52 x 66,5 cm (H x W) <i>to be combined with the specific A1100AK fitting kit</i>	
<b>KAF1100</b> ↘	Specific Airstream sliding wind-screen transparent. Maximum height 48 cm (12 cm of extension), width 67 cm <i>complete with specific fitting kit</i>	
<b>HONDA SH 300I (15 → 18)</b>		
 <b>KR1155</b>	Specific rear rack for <b>MONOLOCK®</b> top-case <i>to be combined with the plate already included in the <b>MONOLOCK®</b> top-case</i>	
 <b>KD1100ST</b>	Specific transparent low screen to be fixed with original Honda fitting kit. 27 x 42 cm (H x W) <i>it does not protect the hand area</i>	
<b>KD1143ST</b>	Specific wind-screen to be fixed with original Honda fitting kit 51,5 x 49 cm (H x W) <i>It does not protect the hand area</i>	
<b>KD1143S</b>	Specific smoked low screen to be fixed with original Honda fitting kit. 27 x 42 cm (H x W) <i>It does not protect the hand area</i>	
<b>HONDA CB 300 R (18 → 19) <span style="background-color: orange; color: white; padding: 2px;">NEW</span></b>		
 <b>KR1169</b>	Specific rear rack for <b>MONOLOCK®</b> top-case <i>to be combined with the plate already included in the <b>MONOLOCK®</b> top-case</i>	
 <b>BF41K</b>	Specific flange for fitting the tank bags with TANKLOCK system	
 <b>KA1164</b>	Specific screen, smoked 21 x 28 cm (H x W) <i>complete with specific fitting kit</i>	
<b>HONDA SILVER WING 400 (06 → 09)</b>		
 <b>KR19</b>	Specific rear rack for <b>MONOKEY®</b> top-case <b>MONOKEY®</b> plate included / you must puncture the original case holder / it is necessary to puncture the housing behind the saddle in arranged sections	
<b>KR19M</b>	Specific rear rack for <b>MONOLOCK®</b> top-case <b>MONOLOCK®</b> plate included / you must puncture the original case holder / it is necessary to puncture the housing behind the saddle in arranged sections	
 <b>214DTK</b>	Specific screen, transparent 63 x 60 cm (H x W) <i>to be combined with the specific D214KITK fitting kit/ 10 cm higher than the original</i>	
<b>D214KITK</b>	Specific fitting kit for 214DTK	
<b>KAF214</b>	Specific Airstream sliding wind-screen transparent. Maximum height 57 cm (12 cm of extension) width 59 cm <i>complete with specific fitting kit / to be mounted instead of the original screen</i>	
<b>VARIOUS ACCESSORIES</b> <b>KTB19</b>	Specific backrest <i>It can be mounted with the KR19, KR19M</i>	
<b>HONDA SW-T 400/600 (09 → 17)</b>		
 <b>KR19</b>	Specific rear rack for <b>MONOKEY®</b> top-case <b>MONOKEY®</b> plate included / you must puncture the original case holder / it is necessary to puncture the housing behind the saddle in arranged sections	
<b>KR19M</b>	Specific rear rack for <b>MONOLOCK®</b> top-case <b>MONOLOCK®</b> plate included / you must puncture the original case holder / it is necessary to puncture the housing behind the saddle in arranged sections	



CODICE	DESCRIZIONE	PREZZO
 <b>KD318ST</b>	Specific screen, transparent, 89 x 67 cm (H x W) <i>to be mounted instead of the original screen / 18 cm higher than the original</i>	
<b>KAF318</b>	Specific sliding wind-screen transparent, AISTREAM. Maximum height 78 cm (12 cm of extension) width 66 cm <i>complete with specific fitting kit / to be mounted instead of the original screen</i>	
<b>VARIOUS ACCESSORIES</b> <b>KTB19</b>	Specific backrest <i>It can be mounted with the KR19, KR19M</i>	
<b>HONDA</b>	<b>CB 500 (97 → 05) / CB 500 S (00 → 05)</b>	
 <b>K2500</b>	Specific rear rack for <b>MONOKEY®</b> or <b>MONOLOCK®</b> top-case <i>To be combined with the plate <b>MONOKEY®</b> K553N, or with the plate <b>MONOLOCK®</b> MKN</i>	
<b>HONDA</b>	<b>CB 500 F (13 → 15)</b>	
 <b>KR1119</b>	Specific rear rack for <b>MONOLOCK®</b> top-case <i>to be combined with the plate already included in the <b>MONOLOCK®</b> top-case</i>	
 <b>KL1119</b>	Specific pannier holder for <b>MONOKEY®</b> side-cases <i>it can be mounted only with the specific rear rack KR1119/you can only mount cases <b>MONOKEY®</b> K22</i>	
 <b>TE1119K</b>	Specific holder for soft side bags or for semi-rigid side bags (RA314) <i>it can be mounted only with the specific rear rack KR1119</i>	
 <b>KA1126</b>	Specific screen, smoked 28.5 x 36 cm (H x W) <i>complete with specific fitting kit</i>	
<b>HONDA</b>	<b>CB 500 F (16 → 18)</b>	
 <b>KZ1152</b>	Specific rear rack for <b>MONOKEY®</b> or <b>MONOLOCK®</b> top-case <i>to be combined with the <b>MONOKEY®</b> KM5, KM7 plate, or with the <b>MONOLOCK®</b> KM5M or KM6M plate</i>	
 <b>KLX1152</b>	Specific pannier holder for K33 <b>MONOKEY®</b> SIDE cases <i>it can be mounted without the specific rear rack KZ1152 using the 1152KITK</i>	
<b>1152KITK</b>	Specific kit to install the KLX1152 without the specific rear rack KZ1152	
 <b>BF20K</b>	Specific flange for fitting the tank bags with TANKLOCK system	
 <b>KA1152</b>	Specific screen, smoked 31,2 x 40,8 cm (H x W) <i>complete with specific fitting kit</i>	
<b>KA1152BL</b>	Specific BLUE LINE screen, 28 x 36,5 cm (H x W) <i>complete with specific fitting kit / when illuminated by vehicle headlights in low light conditions, the edge glows blue in colour</i>	
<b>VARIOUS ACCESSORIES</b> <b>KHP1152</b>	Specific hands protector in ABS	
<b>02SKITK</b>	Specific kit to mounting the KS900A Smart Bar	
<b>HONDA</b>	<b>CBR 500 R (13 → 15)</b>	
 <b>KR1119</b>	Specific rear rack for <b>MONOLOCK®</b> top-case <i>to be combined with the plate already included in the <b>MONOLOCK®</b> top-case</i>	
 <b>KL1119</b>	Specific pannier holder for <b>MONOKEY®</b> side-cases <i>it can be mounted only with the specific rear rack KR1119/you can only mount cases <b>MONOKEY®</b> K22</i>	
 <b>TE1119K</b>	Specific holder for soft side bags or for semi-rigid side bags (RA314) <i>it can be mounted only with the specific rear rack KR1119</i>	
<b>HONDA</b>	<b>CB 500 X (13 → 18)</b>	
 <b>KZ1121</b>	Specific rear rack for <b>MONOKEY®</b> or <b>MONOLOCK®</b> top-case <i>to be combined with the <b>MONOKEY®</b> KM5, KM7, KM8A, KM8B, KM9A or KM9B plate, or with the <b>MONOLOCK®</b> KM5M or KM6M plate / if combined with KM8A, KM8B, KM9A, KM9B it does not allow the assembly of the stop light kit or the remote control device on the case / maximum load allowed 6 kg / it is not compatible with the original side-case holder</i>	
 <b>KL1121</b>	Specific pannier holder for <b>MONOKEY®</b> , RETRO FIT side-cases <i>you can only mount cases Garda KGR33, Garda KGR46, K21 e K22 / to be combined with KL1121KIT from 2017 / it can be mounted without the specific rear rack KZ1121 using the 1121KITK / To ensure the best visibility of the rear indicators mounted with the cases, you need to relocate them by using kit IN1121KIT.</i>	
<b>KTL1146KIT</b>	Specific kit to install the KS250 Tool Box on KL1121 <i>to be combined with KS250 and KL1121 / it can be mounted on either the right-hand side or left-hand side of the motorcycle</i>	
<b>IN1121KITK</b>	Specific kit to move the indicators to ensure the highest visibility with the fitted cases <i>is not necessary if you have the K21N e K22N</i>	
<b>KLX1121</b>	Specific pannier holder for K33 <b>MONOKEY®</b> SIDE cases <i>to be combined with KL1121KIT from 2017 / it can be mounted without the specific rear rack KZ1121 using the 1121KITK</i>	
<b>1121KITK</b>	Specific kit to install the KLX1121 without the specific rear rack KZ1121	

















CODICE	DESCRIZIONE	PRICE
<b>KL1121KIT</b>	Specific kit to install the KL1121, KLX1121 on CB500X from 2017	
 <b>BF20K</b>	Specific flange for fitting the tank bags with TANKLOCK system <i>compatible from 2016</i>	
 <b>KD1121ST</b>	Specific screen, transparent 49 x 37,5 cm (H x W) <i>to be mounted instead of the original screen / 19 cm higher than original</i>	
 <b>KN1121</b>	Specific engine guard <i>25 mm diameter steel tube / we recommend fitting by a qualified mechanic / black colour</i>	
<b>KPR1121</b>	Stainless steel specific radiator guard black painted <i>compatible from 2016</i>	
<b>VARIOUS ACCESSORIES</b> <b>KRM02</b>	Universal spray guard <i>it needs to be paired with the specific mounting kit (RM1121KITK)</i>	
<b>RM1121KITK</b>	Specific kit for spray guard KRM02 <i>compatible from 2016 to 2018</i>	
<b>KHP1121</b>	Specific hands protector in ABS	
<b>ES1111K</b>	Specific support in aluminium and stainless steel to widen the surface support area of the original side stand	
<b>02SKITK</b>	Specific kit to mounting the KS900A Smart Bar	























HONDA	CBF 500 (04 → 12)
 <b>KZ260</b>	Specific rear rack for <b>MONOKEY®</b> or <b>MONOLOCK®</b> top-case <i>to be combined with the MONOKEY® KM5, KM8A, KM8B, KM9A or KM9B plate, or with the MONOLOCK® KM5M or KM6M plate / if combined with KM8A, KM8B, KM9A, KM9B it does not allow the assembly of the stop light kit or the remote control device on the case / It is not compatible with the original side-case holder</i>
 <b>KL174</b>	Specific pannier holder for <b>MONOKEY®</b> side-cases <i>not compatible with the side-cases in aluminium KVE37 K-venture</i>
<b>KLXR174</b>	Specific rapid release side-case holder for K33 <b>MONOKEY® SIDE</b> cases
<b>KLX174</b>	Specific pannier holder for K33 <b>MONOKEY® SIDE</b> cases <i>it can be mounted without the specific rear rack KZ260 using the PLX174KIT</i>
<b>KLX174KIT</b>	Specific kit to install the KLX without the rack for the top-case
 <b>TK218</b>	Specific holder for soft side bags











HONDA	CMX 500 REBEL (17 → 18)
 <b>KR1160</b>	Specific rear rack for <b>MONOLOCK®</b> or <b>MONOKEY®</b> top-case <i>to be combined with the K636 MONOKEY® plate (sold separately), or with the plate already included in the MONOLOCK® top-cases</i>
 <b>TMT1160K</b>	Specific holder for soft side bags or for a pair of CR601U side bags
 <b>100ALK</b>	Grey anodized aluminium universal screen Race Cafe, for naked motorcycles 20,5 x 26,5 cm (H x W) <i>to be combined with the specific AL1160AK fitting kit</i>
<b>100ALBK</b>	Black anodized aluminium universal screen Race Cafe, for naked motorcycles 20,5 x 26,5 cm (H x W) <i>to be combined with the specific AL1160AK fitting kit</i>
<b>140AK</b>	Universal transparent screen 35 x 41cm (H x W) <i>to be combined with the specific AL1160AK fitting kit</i>
<b>140SK</b>	Universal smoked screen 35 x 41 cm (H x W) <i>to be combined with the specific AL1160AK fitting kit</i>
 <b>TMT1160K</b>	Specific holder for soft side bags or for a pair of CR601U side bags
 <b>AL1160AK</b>	Specific fitting kit for 100ALK, 100ALBK, 140AK, 140SK
 <b>KN1160</b>	Specific engine guard, black <i>25 mm diameter steel tube / we recommend fitting by a qualified mechanic</i>
<b>VARIOUS ACCESSORIES</b> <b>KTS1160B</b>	Backrest with detachable small luggage carrier, black

HONDA	CBF 600 S/ CBF 600 N (04 → 12)
 <b>KZ260</b>	Specific rear rack for <b>MONOKEY®</b> or <b>MONOLOCK®</b> top-case <i>to be combined with the MONOKEY® KM5, KM8A, KM8B, KM9A or KM9B plate, or with the MONOLOCK® KM5M or KM6M plate / if combined with KM8A, KM8B, KM9A, KM9B it does not allow the assembly of the stop light kit or the remote control device on the case / It is not compatible with the original side-case holder</i>
 <b>KL174</b>	Specific pannier holder for <b>MONOKEY®</b> side-cases <i>not compatible with the side-cases in aluminium KVE37 K-venture</i>





CODICE	DESCRIZIONE	PREZZO
<b>KLXR174</b>	Specific rapid release side-case holder for K33 <b>MONOKEY® SIDE</b> cases	
<b>KLX174</b>	Specific pannier holder for K33 <b>MONOKEY® SIDE</b> cases <i>it can be mounted without the specific rear rack KZ260 using the PLX174KIT</i>	
<b>KLX174KIT</b>	Specific kit to install the KLX without the rack for the top-case	
 <b>TK218</b>	Specific holder for soft side bags	
 <b>BF03K</b>	Specific flange for fitting the tank bags with TANKLOCK system	
 <b>KD303ST</b>	Specific screen, transparent 54 x 39,5 cm (H x W) <i>only for CBF 600 S / to be mounted instead of the original screen / 12,5 cm higher than original</i>	
 <b>KN369</b>	Specific engine guard <i>we recommend fitting by a qualified mechanic / compatible with all years '07</i>	
<b>KN456</b>	Specific engine guard <i>we recommend fitting by a qualified mechanic / compatible from '08</i>	
<b>VARIOUS ACCESSORIES</b> <b>01SKITK</b>	Specific kit to mounting the KS900A Smart Bar	
<b>HONDA CBR 600 F (99 → 09)</b>		
 <b>K2520</b>	Specific rear rack for <b>MONOKEY®</b> or <b>MONOLOCK®</b> top-case <i>To be combined with the plate <b>MONOKEY®</b> K553N, or with the plate <b>MONOLOCK®</b> MKN</i>	
<b>HONDA CBR 600 F (11 → 13) NEW</b>		
 <b>KZ1102</b>	Specific rear rack for <b>MONOKEY®</b> or <b>MONOLOCK®</b> top-case <i>to be combined with the <b>MONOKEY®</b> KM5, KM7, KM8A, KM8B, KM9A or KM9B plate, or with the <b>MONOLOCK®</b> KM5M or KM6M plate / if combined with KM8A, KM8B, KM9A, KM9B it does not allow the assembly of the stop light kit or the remote control device on the case</i>	
 <b>BF03K</b>	Specific flange for fitting the tank bags with TANKLOCK system	
 <b>1105DK</b>	Specific screen, smoked 39,5 x 36 cm (H x W) <i>to be combined with the specific D1105KITK fitting kit / 5,5 cm higher than the original</i>	
<b>D1105KITK</b>	Specific fitting kit for 1105DK	
<b>HONDA CBR 600 RR (05 → 06)</b>		
 <b>BF03K</b>	Specific flange for fitting the tank bags with TANKLOCK system	
<b>HONDA CBR 600 RR (07 → 09)</b>		
 <b>BF03K</b>	Specific flange for fitting the tank bags with TANKLOCK system	
<b>HONDA HORNET 600 / S (98 → 02)</b>		
 <b>KZ162</b>	Specific rear rack for <b>MONOKEY®</b> or <b>MONOLOCK®</b> top-case <i>to be combined with the <b>MONOKEY®</b> KM5, KM7, KM8A, KM8B, KM9A or KM9B plate, or with the <b>MONOLOCK®</b> KM5M or KM6M plate / if combined with KM8A, KM8B, KM9A, KM9B it does not allow the assembly of the stop light kit or the remote control device on the case</i>	
 <b>TK214</b>	Specific holder for soft side bags	
<b>HONDA HORNET 600 (03 → 06)</b>		
 <b>KZ258</b>	Specific rear rack for <b>MONOKEY®</b> or <b>MONOLOCK®</b> top-case <i>to be combined with the <b>MONOKEY®</b> KM5, KM7, KM8A, KM8B, KM9A or KM9B plate, or with the <b>MONOLOCK®</b> KM5M or KM6M plate / if combined with KM8A, KM8B, KM9A, KM9B it does not allow the assembly of the stop light kit or the remote control device on the case / Bronze colour</i>	
 <b>TK214</b>	Specific holder for soft side bags	
 <b>KA305</b>	Specific screen, smoked 31,2 x 40,8 cm (H x W) <i>compatible with models from '05 to '06 / complete with fitting kit / it can be mounted without removing the original front light fairing</i>	



CODICE	DESCRIZIONE	PRICE
<b>HONDA HORNET 600 / HORNET 600 ABS (07 → 10)</b>		
 <b>KZ263</b>	Specific rear rack for <b>MONOKEY®</b> or <b>MONOLOCK®</b> top-case to be combined with the <b>MONOKEY®</b> KM5, KM7, KM8A, KM8B, KM9A or KM9B plate, or with the <b>MONOLOCK®</b> KM5M or KM6M plate / if combined with KM8A, KM8B, KM9A, KM9B it does not allow the assembly of the stop light kit or the remote control device on the case / you must remove the original grab handles they are reproduced by the rack itself	
 <b>TK219</b>	Specific holder for soft side bags	
 <b>BF03K</b>	Specific flange for fitting the tank bags with TANKLOCK system	
 <b>KA309</b>	Specific screen, smoked 33,5 x 40,5 cm (H x W) only for CB 600 F Hornet / complete with fitting kit	
<b>KA310</b>	Specific screen, smoked 33,5 x 40,5 cm (H x W) only for Hornet ABS / complete with fitting kit	
 <b>KN453</b>	Specific engine guard 25 mm diameter steel tube / we recommend fitting by a qualified mechanic	
<b>VARIOUS ACCESSORIES</b> <b>02SKITK</b>	Specific kit to mounting the KS900A Smart Bar	
<b>HONDA HORNET 600 (11 → 13)</b>		
 <b>KZ1102</b>	Specific rear rack for <b>MONOKEY®</b> or <b>MONOLOCK®</b> top-case to be combined with the <b>MONOKEY®</b> KM5, KM7, KM8A, KM8B, KM9A or KM9B plate, or with the <b>MONOLOCK®</b> KM5M or KM6M plate / if combined with KM8A, KM8B, KM9A, KM9B it does not allow the assembly of the stop light kit or the remote control device on the case	
 <b>BF03K</b>	Specific flange for fitting the tank bags with TANKLOCK system	
 <b>KN453</b>	Specific engine guard 25 mm diameter steel tube / we recommend fitting by a qualified mechanic	
<b>VARIOUS ACCESSORIES</b> <b>02SKITK</b>	Specific kit to mounting the KS900A Smart Bar	
<b>HONDA SILVER WING 600 / ABS (01 → 09)</b>		
 <b>KR19</b>	Specific rear rack for <b>MONOKEY®</b> top-case <b>MONOKEY®</b> plate included / you must puncture the original case holder / it is necessary to puncture the housing behind the saddle in arranged sections	
<b>KR19M</b>	Specific rear rack for <b>MONOLOCK®</b> top-case <b>MONOLOCK®</b> plate included / you must puncture the original case holder / it is necessary to puncture the housing behind the saddle in arranged sections	
 <b>214DTK</b>	Specific screen, transparent 63 x 60 cm (H x W) to be combined with the specific D214KITK fitting kit/ 10 cm higher than the original	
<b>D214KITK</b>	Specific fitting kit for 214DTK	
<b>KAF214</b>	Specific Airstream sliding wind-screen transparent. Maximum height 57 cm (12 cm of extension) width 59 cm complete with specific fitting kit / to be mounted instead of the original screen	
<b>VARIOUS ACCESSORIES</b> <b>KTB19</b>	Specific backrest It can be mounted with the KR19, KR19M	
<b>HONDA XL 600 RM/LM</b>		
 <b>K200</b>	Specific rear rack for <b>MONOKEY®</b> top-case <b>MONOKEY®</b> plate included	
<b>HONDA XL 600 V TRANSALP (88)</b>		
 <b>K200</b>	Specific rear rack for <b>MONOKEY®</b> top-case <b>MONOKEY®</b> plate included	
<b>HONDA XL 600 V TRANSALP (89 → 93)</b>		
 <b>K200</b>	Specific rear rack for <b>MONOKEY®</b> top-case <b>MONOKEY®</b> plate included	
 <b>KD180S</b>	Specific screen, smoked 43,7 x 43,9 cm (H x W) complete with specific fitting kit	
 <b>KN22</b>	Specific engine guard 22 mm diameter steel tube / we recommend fitting by a qualified mechanic	







CODICE	DESCRIZIONE	PREZZO
<b>HONDA XL 600 V TRANSALP (94 → 96)</b>		
 <b>K200</b>	Specific rear rack for <b>MONOKEY</b> ® top-case <b>MONOKEY</b> ® plate included	
 <b>KL131</b>	Specific pannier holder for <b>MONOKEY</b> ®, RETRO FIT side-cases	
 <b>KD191S</b>	Specific screen, smoked 44,1 x 38,4 cm (H x W) <i>to be mounted instead of the original screen</i>	
 <b>KN22</b>	Specific engine guard <i>22 mm diameter steel tube / we recommend fitting by a qualified mechanic</i>	
<b>HONDA XL 600 V TRANSALP (97 → 99)</b>		
 <b>KL131</b>	Specific pannier holder for <b>MONOKEY</b> ®, RETRO FIT side-cases	
 <b>KD191S</b>	Specific screen, smoked 44,1 x 38,4 cm (H x W) <i>to be mounted instead of the original screen</i>	
 <b>KN22</b>	Specific engine guard <i>22 mm diameter steel tube / we recommend fitting by a qualified mechanic</i>	
<b>HONDA CB 650 F (14 → 16) / CBR 650 F (14 → 16)</b>		
 <b>KZ1137</b>	Specific rear rack for <b>MONOKEY</b> ® or <b>MONOLOCK</b> ® top-case <i>to be combined with the MONOKEY® KM5, KM7, KM8A, KM8B, KM9A or KM9B plate, or with the MONOLOCK® KM5M or KM6M plate / if combined with KM8A, KM8B, KM9A, KM9B it does not allow the assembly of the stop light kit or the remote control device on the case</i>	
 <b>KLX1137</b>	Specific pannier holder for K33 <b>MONOKEY</b> ® <b>SIDE</b> cases <i>it can be mounted without the specific rear rack KZ1137 using the 1137KIT</i>	
 <b>BF20K</b>	Specific flange for fitting the tank bags with TANKLOCK system	
 <b>TE1137K</b>	Specific holder for soft side bags or for semi-rigid side bags (RA314) <i>it can be mounted without the specific rear rack KZ1137 using the 1137KIT</i>	
 <b>KA1137</b>	Specific screen, smoked 28.5 x 36 cm (H x W) <i>only for CB 650 F / complete with fitting kit</i>	
 <b>KD1138S</b>	Specific screen, smoked 38 x 37,5 cm (H x W) <i>only for CBR 650 F / to be mounted instead of the original screen / 5 cm higher than original</i>	
<b>VARIOUS ACCESSORIES</b> <b>KHP1137</b>	Specific hands protector in ABS <i>only for CB 650 F</i>	
<b>02SKITK</b>	Specific kit to mounting the KS900A Smart Bar <i>only for CB 650 F</i>	
<b>HONDA CB 650F (17 → 18)</b>		
 <b>KZ1137</b>	Specific rear rack for <b>MONOKEY</b> ® or <b>MONOLOCK</b> ® top-case <i>to be combined with the MONOKEY® KM5, KM7, KM8A, KM8B, KM9A or KM9B plate, or with the MONOLOCK® KM5M or KM6M plate / if combined with KM8A, KM8B, KM9A, KM9B it does not allow the assembly of the stop light kit or the remote control device on the case</i>	
 <b>KLX1137</b>	Specific pannier holder for K33 <b>MONOKEY</b> ® <b>SIDE</b> cases <i>it can be mounted without the specific rear rack KZ1137 using the 1137KIT</i>	
 <b>TE1137K</b>	Specific holder for soft side bags or for semi-rigid side bags (RA314) <i>it can be mounted without the specific rear rack KZ1137 using the 1137KIT</i>	
 <b>BF30K</b>	Specific flange for fitting the tank bags with TANKLOCK system	
 <b>KA1159</b>	Specific screen, smoked 28 x 36,5 cm (H x W) <i>complete with specific fitting kit</i>	
 <b>KA1159BL</b>	Specific BLUE LINE screen, 28 x 36,5 cm (H x W) <i>complete with specific fitting kit / when illuminated by vehicle headlights in low light conditions, the edge glows blue in colour</i>	
<b>VARIOUS ACCESSORIES</b> <b>KHP1159</b>	Specific hands protector in ABS	
<b>02SKITK</b>	Specific kit to mounting the KS900A Smart Bar	
<b>HONDA NT 650 V DEAUVILLE (98 → 05)</b>		
 <b>KR15</b>	Specific rear rack for <b>MONOKEY</b> ® top-case <b>MONOKEY</b> ® plate included	
 <b>KR15M</b>	Specific rear rack for <b>MONOLOCK</b> ® top-case <b>MONOLOCK</b> ® plate included	
 <b>KD201S</b>	Specific screen, smoked 45 x 40,3 cm (H x W) <i>to be mounted instead of the original screen</i>	

















CODICE	DESCRIZIONE	PRICE
<b>HONDA XL 650 V TRANSALP (00 → 07)</b>		
 <b>K213</b>	Specific rear rack for <b>MONOKEY®</b> top-case <b>MONOKEY®</b> plate included	
 <b>KL167</b>	Specific pannier holder for <b>MONOKEY®</b> , RETRO FIT side-cases	
 <b>TK213</b>	Specific holder for soft side bags	
 <b>KD209S</b>	Specific screen, smoked 56 x 36 cm (H x W) <i>to be mounted instead of the original screen</i>	
 <b>KN26</b>	Specific engine guard 25 mm diameter steel tube / it can be mounted with the central stand installed / we recommend fitting by a qualified mechanic	
<b>HONDA CTX 700 DCT (14 → 16)</b>		
 <b>KZ1133</b>	Specific rear rack for <b>MONOKEY®</b> or <b>MONOLOCK®</b> top-case <i>to be combined with the MONOKEY® KM5, KM7, KM8A, KM8B, KM9A or KM9B plate, or with the MONOLOCK® KM5M or KM6M plate / if combined with KM8A, KM8B, KM9A, KM9B it does not allow the assembly of the stop light kit or the remote control device on the case</i>	
 <b>KD1133ST</b>	Specific screen, transparent 48 x 62 cm (h x w) <i>to be mounted instead of the original screen</i>	
<b>VARIOUS ACCESSORIES</b> <b>01SKITK</b>	Specific kit to mounting the KS900A Smart Bar	
<b>HONDA CTX 700 N DCT (14 → 16)</b>		
 <b>KZ1131</b>	Specific rear rack for <b>MONOKEY®</b> or <b>MONOLOCK®</b> top-case <i>to be combined with the MONOKEY® KM5, KM7, KM8A, KM8B, KM9A or KM9B plate, or with the MONOLOCK® KM5M or KM6M plate / if combined with KM8A, KM8B, KM9A, KM9B it does not allow the assembly of the stop light kit or the remote control device on the case</i>	
<b>VARIOUS ACCESSORIES</b> <b>01SKITK</b>	Specific kit to mounting the KS900A Smart Bar	
<b>HONDA DN-01 700 (08 → 14)</b>		
 <b>KZ265</b>	Specific rear rack for <b>MONOKEY®</b> or <b>MONOLOCK®</b> top-case <i>to be combined with the MONOKEY® KM5, KM7, KM8A, KM8B, KM9A or KM9B plate, or with the MONOLOCK® KM5M or KM6M plate / if combined with KM8A, KM8B, KM9A, KM9B it does not allow the assembly of the stop light kit or the remote control device on the case / maximum load allowed 6 kg / black colour / it is necessary to puncture the housing behind the saddle</i>	
 <b>KLX204</b>	Specific pannier holder for K33 <b>MONOKEY®</b> SIDE cases <i>it can be mounted only with the specific rear rack KZ265</i>	
 <b>KD316S</b>	Specific screen, smoked 66 x 45 cm (H x W) <i>to be mounted instead of the original screen</i>	
<b>HONDA INTEGRA 700 (12 → 13)</b>		
 <b>KZ1109</b>	Specific rear rack for <b>MONOKEY®</b> or <b>MONOLOCK®</b> top-case <i>to be combined with the MONOKEY® KM5, KM7, KM8A, KM8B, KM9A or KM9B plate, or with the MONOLOCK® KM5M or KM6M plate / if combined with KM8A, KM8B, KM9A, KM9B it does not allow the assembly of the stop light kit or the remote control device on the case</i>	
 <b>KLX1109</b>	Specific pannier holder for K33 <b>MONOKEY®</b> SIDE cases <i>it can be mounted without the specific rear rack KZ1109 using the 1109KITK</i>	
<b>1109KITK</b>	Specific kit to install the KLX1109 / KL1109 / TE1109K without the specific rear rack	
 <b>KD1109ST</b>	Specific screen, transparent 72 x 69 cm (H x W) <i>to be mounted instead of the original screen / 11 cm higher than the original wind-screen</i>	
<b>KD1109B</b>	Specific low and sports screen gloss black 47 x 43 cm (H x W) <i>to be mounted instead of the original screen</i>	
<b>VARIOUS ACCESSORIES</b> <b>KMG1109</b>	Mudguard/specific ABS chain-cover, black colour	
<b>ES1111K</b>	Specific support in aluminium and stainless steel to widen the surface support area of the original side stand	
<b>HONDA NC 700 S (12 → 13) / NC 750 S / NC 750 S DCT (14 → 15)</b>		
 <b>KZ1111</b>	Specific rear rack for <b>MONOKEY®</b> or <b>MONOLOCK®</b> top-case <i>to be combined with the MONOKEY® KM5, KM7, KM8A, KM8B, KM9A or KM9B plate, or with the MONOLOCK® KM5M or KM6M plate / if combined with KM8A, KM8B, KM9A, KM9B it does not allow the assembly of the stop light kit or the remote control device on the case</i>	
 <b>KLX1111</b>	Specific pannier holder for K33 <b>MONOKEY®</b> SIDE cases <i>it can be mounted without the specific rear rack KZ1111 using the 1111KIT</i>	









CODICE	DESCRIZIONE	PREZZO
KL1111	Specific pannier holder for <b>MONOKEY</b> ®, RETRO FIT side-cases <i>it can be mounted without the specific rear rack KZ1111 using the 1111KIT</i>	
 TE1111K	Specific holder for soft side bags or for semi-rigid side bags (RA314) <i>it can be mounted without the specific rear rack KZ1111 using the 1111KIT</i>	
 KD1112S	Specific screen, smoked 31 x 36 cm (H x W) <i>to be mounted instead of the original screen / 6.5 cm higher than original</i>	
 KN1111	Specific engine guard <i>25 mm diameter steel tube / we recommend fitting by a qualified mechanic</i>	
<b>VARIOUS ACCESSORIES</b> KMG1109	Mudguard/specific ABS chain-cover, black colour	
ES1111K	Specific support in aluminium and stainless steel to widen the surface support area of the original side stand	
02SKITK	Specific kit to mounting the KS900A Smart Bar	

HONDA		NC 700 X (12 → 13) / NC 750 X / NC 750 X DCT (14 → 15)
 KZ1111	Specific rear rack for <b>MONOKEY</b> ® or <b>MONOLOCK</b> ® top-case <i>to be combined with the MONOKEY® KM5, KM7, KM8A, KM8B, KM9A or KM9B plate, or with the MONOLOCK® KM5M or KM6M plate / if combined with KM8A, KM8B, KM9A, KM9B it does not allow the assembly of the stop light kit or the remote control device on the case</i>	
 KLX1111	Specific pannier holder for K33 <b>MONOKEY</b> ® SIDE cases <i>it can be mounted without the specific rear rack KZ1111 using the 1111KIT</i>	
KL1111	Specific pannier holder for <b>MONOKEY</b> ®, RETRO FIT side-cases <i>it can be mounted without the specific rear rack KZ1111 using the 1111KIT</i>	
 TE1111K	Specific holder for soft side bags or for semi-rigid side bags (RA314) <i>it can be mounted without the specific rear rack KZ1111 using the 1111KIT</i>	
 KD1111ST	Specific screen, transparent 49,5 x 41 cm (H x W) <i>to be mounted instead of the original screen / 16.5 cm higher than the original</i>	
<b>VARIOUS ACCESSORIES</b> KHP1111	Specific hands protector in ABS	
 KN1111	Specific engine guard <i>25 mm diameter steel tube / we recommend fitting by a qualified mechanic</i>	
<b>VARIOUS ACCESSORIES</b> KMG1109	Mudguard/specific ABS chain-cover, black colour	
ES1111K	Specific support in aluminium and stainless steel to widen the surface support area of the original side stand	
02SKITK	Specific kit to mounting the KS900A Smart Bar	











HONDA		NT 700 DEAUVILLE (06 → 12)
 K221	Specific rear rack for <b>MONOKEY</b> ® top-case <b>MONOKEY</b> ® plate included / for fixing the original lid must be drilled / it is necessary to puncture the housing behind the saddle	
K221M	Specific rear rack for <b>MONOLOCK</b> ® top-case <b>MONOLOCK</b> ® plate included / for fixing the original lid must be drilled / it is necessary to puncture the housing behind the saddle	
 BF03K	Specific flange for fitting the tank bags with TANKLOCK system	
 KD307ST	Specific screen, transparent 49 x 46,5 cm (H x W) <i>to be mounted instead of the original screen</i>	















HONDA		XL 700 V TRANSALP (08 → 13)
 K225	Specific rear rack for <b>MONOKEY</b> ® top-case <b>MONOKEY</b> ® plate included	
K225M	Specific rear rack for <b>MONOLOCK</b> ® top-case <b>MONOLOCK</b> ® plate included	
 KL203	Specific pannier holder for <b>MONOKEY</b> ® side-cases <i>not compatible with the side-cases in aluminium KVE37 K-venture</i>	
 TK221	Specific holder for soft side bags	
 BF03K	Specific flange for fitting the tank bags with TANKLOCK system	
 KD313S	Specific screen, smoked 44,5 x 37 cm (H x W) <i>to be mounted instead of the original screen / 15,5 cm higher than original</i>	
 KN455	Specific engine guard <i>25 mm diameter steel tube / we recommend fitting by a qualified mechanic</i>	

















CODICE	DESCRIZIONE	PRICE
<b>VARIOUS ACCESSORIES</b> ES1111K	Specific support in aluminium and stainless steel to widen the surface support area of the original side stand	
03SKITK	Specific kit to mounting the KS900A Smart Bar	
<b>HONDA AFRICA TWIN 750 (90 → 92)</b>		
 K200	Specific rear rack for <b>MONOKEY</b> ® top-case <b>MONOKEY</b> ® plate included	
 KN23	Specific engine guard 22 mm diameter steel tube / we recommend fitting by a qualified mechanic / black colour	
<b>HONDA AFRICA TWIN 750 (93 → 95)</b>		
 K210	Specific rear rack for <b>MONOKEY</b> ® top-case <b>MONOKEY</b> ® plate included	
 KL148	Specific pannier holder for <b>MONOKEY</b> ®, RETRO FIT side-cases	
 KN23	Specific engine guard 22 mm diameter steel tube / we recommend fitting by a qualified mechanic / black colour	
<b>VARIOUS ACCESSORIES</b> 02SKITK	Specific kit to mounting the KS900A Smart Bar	
<b>HONDA AFRICA TWIN 750 (96 → 02)</b>		
 K210	Specific rear rack for <b>MONOKEY</b> ® top-case <b>MONOKEY</b> ® plate included	
 KL148	Specific pannier holder for <b>MONOKEY</b> ®, RETRO FIT side-cases	
 KD195S	Specific screen, smoked 44 x 35 cm (H x W) to be mounted instead of the original screen	
 KN23	Specific engine guard 22 mm diameter steel tube / we recommend fitting by a qualified mechanic / black colour	
<b>HONDA BLACK WIDOW 750 (00 → 02)</b>		
 23A	Universal screen, 38,8 x 41 cm (H x W) to be combined with the specific AS100A2 fitting kit	
AS100A2K	Specific fitting kit for 23A and A35NK	
<b>HONDA CB 750 SEVEN FIFTY (92 → 00)</b>		
 K2320	Specific rear rack for <b>MONOKEY</b> ® or <b>MONOLOCK</b> ® top-case To be combined with the plate <b>MONOKEY</b> ® K553N, or with the plate <b>MONOLOCK</b> ® MKN	
<b>HONDA INTEGRA 750 (14 → 15)</b>		
 KZ1127	Specific rear rack for <b>MONOKEY</b> ® or <b>MONOLOCK</b> ® top-case to be combined with the <b>MONOKEY</b> ® KM5, KM7, KM8A, KM8B, KM9A or KM9B plate, or with the <b>MONOLOCK</b> ® KM5M or KM6M plate / if combined with KM8A, KM8B, KM9A, KM9B it does not allow the assembly of the stop light kit or the remote control device on the case / maximum load allowed 6 kg	
 1127KITK	Specific kit to install the KLX1127 without the specific rear rack KZ1127	
 KD1109ST ↘	Specific screen, transparent 72 x 69 cm (H x W) to be mounted instead of the original screen / 11 cm higher than the original wind-screen	
KD1109B	Specific low and sports screen gloss black 47 x 43 cm (H x W) to be mounted instead of the original screen	
<b>VARIOUS ACCESSORIES</b> KMG1127	Mudguard/specific ABS chain-cover, black colour	
ES1111K	Specific support in aluminium and stainless steel to widen the surface support area of the original side stand	
<b>HONDA INTEGRA 750 (16 → 18) NEW</b>		
 KR11500	Specific rear black rack for <b>MONOLOCK</b> ® or <b>MONOKEY</b> ® top-case to be combined with the <b>MONOKEY</b> ® KM5, KM7 plate, or with the <b>MONOLOCK</b> ® KM5M or KM6M plate	
 KLX1149	Specific pannier holder for K33 <b>MONOKEY</b> ® SIDE cases it can be mounted only with the original rear rack (optional)	

CODICE	DESCRIZIONE	PREZZO
<b>KLX1150</b>	Specific pannier holder for K33 <b>MONOKEY® SIDE</b> cases <i>it can be mounted only with the specific rear rack KR11500</i>	
 <b>KD1109ST</b>	Specific screen, transparent 72 x 69 cm (H x W) <i>to be mounted instead of the original screen / 11 cm higher than the original wind-screen</i>	
<b>KD1109B</b>	Specific low and sports screen gloss black 47 x 43 cm (H x W) <i>to be mounted instead of the original screen</i>	
<b>VARIOUS ACCESSORIES</b> <b>KMG1127</b>	Mudguard/specific ABS chain-cover, black colour	
<b>HONDA X-ADV 750 (17 → 18)</b>		
 <b>KZ1156</b>	Specific rear rack for <b>MONOKEY®</b> or <b>MONOLOCK®</b> top-case <i>to be combined with the MONOKEY® KM5, KM7, KM8A, KM8B, KM9A or KM9B plate, or with the MONOLOCK® KM5M or KM6M plate / if combined with KM8A, KM8B, KM9A, KM9B it does not allow the assembly of the stop light kit or the remote control device on the case / maximum load allowed 6 kg</i>	
<b>KR1156</b>	Specific rear rack for <b>MONOLOCK®</b> or <b>MONOKEY®</b> top-case <i>to be combined with the MONOKEY® KM5, KM7, KM8A, KM8B, KM9A or KM9B plate, or with the MONOLOCK® KM5M or KM6M plate / if combined with KM8A, KM8B, KM9A, KM9B it does not allow the assembly of the stop light kit or the remote control device on the case / It can only be mounted to the original rack (optional)</i>	
 <b>KL1156</b>	Specific pannier holder for <b>MONOKEY®</b> , RETRO FIT side-cases <i>it can be mounted only with the specific rear rack KZ1156</i>	
<b>KL1158</b>	Specific pannier holder for <b>MONOKEY®</b> , RETRO FIT side-cases <i>It can be mounted also to the original rack (optional) / it cannot be mounted with the specific rear rack KZ1156</i>	
<b>VARIOUS ACCESSORIES</b> <b>KTL1156KIT</b>	Specific kit to install the KS250 Tool Box on KL1156, KL1158 <i>to be combined with KS250 and KL1156 or KL1158 / needs to be mounted on the left-hand side of the motorcycle</i>	
 <b>KD1156ST</b>	Specific screen, transparent 65 x 40 cm (H x W) <i>to be mounted instead of the original screen / to ensure total rotation of the handlebar, the windshield cannot be set to either the lowest or the highest settings. It can only be set to the three intermediate settings / 13 cm higher than the original</i>	
 <b>KN1156</b>	Specific engine guard, black <i>25 mm diameter steel tube / we recommend fitting by a qualified mechanic</i>	
<b>KPR1156</b>	Stainless steel specific radiator guard black painted	
<b>VARIOUS ACCESSORIES</b> <b>KMG1156</b>	Specific ABS mudguard, black colour	
<b>KRM02</b>	Universal spray guard <i>It needs to be paired with the specific mounting kit (RM1156KIT)</i>	
<b>RM1156KIT</b>	Specific kit for spray guard KRM02	
<b>KHP1144</b>	Specific hands protector in ABS <i>to be mounted instead of the original hands protector</i>	
<b>ES1156K</b>	Specific support in aluminium and stainless steel to widen the surface support area of the original side stand	
<b>HONDA VFR 750 F (90 → 93)</b>		
 <b>K2290</b>	Specific rear rack for <b>MONOKEY®</b> or <b>MONOLOCK®</b> top-case <i>To be combined with the plate MONOKEY® K553N, or with the plate MONOLOCK® MKN</i>	
<b>HONDA VFR 750 F (94 → 97)</b>		
 <b>K2420</b>	Specific rear rack for <b>MONOKEY®</b> or <b>MONOLOCK®</b> top-case <i>To be combined with the plate MONOKEY® K553N, or with the plate MONOLOCK® MKN</i>	
<b>HONDA VT SHADOW 750 (04 → 14)</b>		
 <b>A41NK</b>	Universal screen, 53,7 x 51,6 cm (H x W) <i>to be combined with the specific AS121A2K fitting kit/ High and shaded bottom version</i>	
<b>23A</b>	Universal screen, 38,8 x 41 cm (H x W) <i>to be combined with the specific AS121A2K fitting kit</i>	
<b>HONDA VT SHADOW SPIRIT 750 (07 → 09)</b>		
 <b>23A</b>	Universal screen, 38,8 x 41 cm (H x W) <i>to be combined with the specific AS100A2 fitting kit</i>	
<b>AS100A2K</b>	Specific fitting kit for 23A and A35NK	



CODICE	DESCRIZIONE	PRICE
<b>HONDA NC 750 X (16 → 18)</b>		
 <b>KZ1146</b>	Specific rear rack for <b>MONOKEY®</b> or <b>MONOLOCK®</b> top-case <i>to be combined with the <b>MONOKEY®</b> KM5, KM7 plate, or with the <b>MONOLOCK®</b> KM5M or KM6M plate</i>	
 <b>KL1146</b>	Specific pannier holder for <b>MONOKEY®</b> , RETRO FIT side-cases <i>it can be mounted without the specific rear rack KZ1146 using the 1146KITK</i>	
<b>KLX1146</b>	Specific pannier holder for K33 <b>MONOKEY®</b> SIDE cases <i>it can be mounted without the specific rear rack KZ1146 using the 1146KITK</i>	
<b>1146KITK</b>	Specific kit to install the KLX1146 / KL1146 / TST1146K without the specific rear rack KZ1146	
 <b>TST1146K</b>	Specific holder for soft side bags <i>it can be mounted without the specific rear rack KZ1146 using the 1146KITK</i>	
 <b>KD1146ST</b>	Specific screen, transparent 48,5 x 40 cm (H x W) <i>not compatible with the original Honda hand protectors / to be mounted instead of the original screen / 10,5 cm higher than the original</i>	
 <b>KN1111</b>	Specific engine guard <i>25 mm diameter steel tube / we recommend fitting by a qualified mechanic</i>	
<b>KPR1146</b>	Stainless steel specific radiator guard black painted	
<b>VARIOUS ACCESSORIES</b> <b>KMG1109</b>	Mudguard/specific ABS chain-cover, black colour	
<b>KRM01</b>	Universal spray guard <i>It needs to be paired with the specific mounting kit (RM1146KITK)</i>	
<b>KRM02</b>	Universal spray guard <i>It needs to be paired with the specific mounting kit (RM1146KITK)</i>	
<b>RM1146KITK</b>	Specific kit for spray guard KRM01, KRM02	
<b>KTL1146KIT</b>	Specific kit to install the KS250 Tool Box on KL1146 <i>to be combined with KS250 and KL1146 / it can be mounted on either the right-hand side or left-hand side of the motorcycle</i>	
<b>LS1146K</b>	Specific fitting kit to mount KS310 or KS322 spotlights where specific engine guard is not present	
<b>KHP1111</b>	Specific hands protector in ABS	
<b>ES1111K</b>	Specific support in aluminium and stainless steel to widen the surface support area of the original side stand	
<b>KFB1146</b>	Fairing upper bracket to be mounted behind the windshield to install KS920M, KS920L and GPS-Smartphone holder <i>Compatible with the original windshield and the windshield KD1146ST / For KS920M, KS920L, KS952B, KS953B, KS954B, KS955B, KS956B</i>	
<b>02SKITK</b>	Specific kit to mounting the KS900A Smart Bar	
<b>HONDA NC 750 S (16 → 18)</b>		
 <b>KZ1146</b>	Specific rear rack for <b>MONOKEY®</b> or <b>MONOLOCK®</b> top-case <i>to be combined with the <b>MONOKEY®</b> KM5, KM7 plate, or with the <b>MONOLOCK®</b> KM5M or KM6M plate</i>	
 <b>KL1146</b>	Specific pannier holder for <b>MONOKEY®</b> , RETRO FIT side-cases <i>it can be mounted without the specific rear rack KZ1146 using the 1146KITK</i>	
<b>KLX1146</b>	Specific pannier holder for K33 <b>MONOKEY®</b> SIDE cases <i>it can be mounted without the specific rear rack KZ1146 using the 1146KITK</i>	
<b>1146KITK</b>	Specific kit to install the KLX1146 / KL1146 / TST1146K without the specific rear rack KZ1146	
 <b>TST1146K</b>	Specific holder for soft side bags <i>it can be mounted without the specific rear rack KZ1146 using the 1146KITK</i>	
 <b>KD1112S</b>	Specific screen, smoked 31 x 36 cm (H x W) <i>to be mounted instead of the original screen / 6.5 cm higher than original</i>	
 <b>KN1111</b>	Specific engine guard <i>25 mm diameter steel tube / we recommend fitting by a qualified mechanic</i>	
<b>KPR1146</b>	Stainless steel specific radiator guard black painted	
<b>VARIOUS ACCESSORIES</b> <b>KMG1109</b>	Mudguard/specific ABS chain-cover, black colour	
<b>KRM01</b>	Universal spray guard <i>It needs to be paired with the specific mounting kit (RM1146KITK)</i>	
<b>KRM02</b>	Universal spray guard <i>It needs to be paired with the specific mounting kit (RM1146KITK)</i>	
<b>RM1146KITK</b>	Specific kit for spray guard KRM01, KRM02	

→	CODICE	DESCRIZIONE	PREZZO
	<b>KHP1111</b>	Specific hands protector in ABS	
	<b>O2SKITK</b>	Specific kit to mounting the KS900A Smart Bar	
<b>HONDA CROSSRUNNER 800 (11 → 14)</b>			
	<b>KZ1104</b>	Specific rear rack for <b>MONOKEY</b> ® or <b>MONOLOCK</b> ® top-case to be combined with the <b>MONOKEY</b> ® KM5, KM7, KM8A, KM8B, KM9A or KM9B plate, or with the <b>MONOLOCK</b> ® KM5M or KM6M plate / if combined with KM8A, KM8B, KM9A, KM9B it does not allow the assembly of the stop light kit or the remote control device on the case	
	<b>KLX1104</b>	Specific pannier holder for K33 <b>MONOKEY</b> ® <b>SIDE</b> cases it can be mounted only with the specific rear rack KZ1104 / you must move the indicators from their original position	
	<b>D1104KITK</b>	Specific fitting kit for 1104DTK	
<b>HONDA CROSSRUNNER 800 (15 → 18)</b>			
	<b>KR1139</b>	Specific rear rack for <b>MONOLOCK</b> ® or <b>MONOKEY</b> ® top-case to be combined with the <b>MONOKEY</b> ® KM5, KM7 plate, or with the <b>MONOLOCK</b> ® KM5M or KM6M plate / maximum load allowed 6 kg	
	<b>KLXR1139</b>	Specific rapid release side-case holder for K33 <b>MONOKEY</b> ® <b>SIDE</b> cases you must move the indicators from their original position	
	<b>KD1139ST</b>	Specific screen, transparent 55 x 42 cm (H x W) compatible from 15 to 16 / to be mounted instead of the original screen / 18 cm higher than the original	
	<b>KD1157ST</b>	Specific screen, transparent 55,5 x 42 cm (H x W) compatible from 17 / to be mounted instead of the original screen / 38 cm higher than the original	
	<b>KAF1139</b>	Specific sliding wind-screen transparent, AIRSTREAM®. Maximum height 56 cm (12 cm of extension) width 42 cm compatible from 15 to 16 / to be mounted instead of the original screen	
	<b>KN1139</b>	Specific engine guard, black 25 mm diameter steel tube / we recommend fitting by a qualified mechanic	
<b>VARIOUS ACCESSORIES</b>	<b>KHP1139</b>	Specific hands protector in ABS	
	<b>ES1139K</b>	Specific support in aluminium and stainless steel to widen the surface support area of the original side stand	
	<b>O3SKITK</b>	Specific kit to mounting the KS900A Smart Bar	
<b>HONDA VFR 800 (98 → 01)</b>			
	<b>KZ257</b>	Specific rear rack for <b>MONOKEY</b> ® or <b>MONOLOCK</b> ® top-case to be combined with the <b>MONOKEY</b> ® KM5, KM7, KM8A, KM8B, KM9A or KM9B plate, or with the <b>MONOLOCK</b> ® KM5M or KM6M plate / if combined with KM8A, KM8B, KM9A, KM9B it does not allow the assembly of the stop light kit or the remote control device on the case / you must remove the grab rails, these are reproduced by the rack itself	
	<b>KL257</b>	Specific pannier holder for <b>MONOKEY</b> ®, RETRO FIT side-cases it can be mounted only with the specific rear rack KZ257	
<b>HONDA VFR 800 VTEC (02 → 11)</b>			
	<b>KZ166</b>	Specific rear rack for <b>MONOKEY</b> ® or <b>MONOLOCK</b> ® top-case to be combined with the <b>MONOKEY</b> ® KM5, KM7, KM8A, KM8B, KM9A or KM9B plate, or with the <b>MONOLOCK</b> ® KM5M or KM6M plate / if combined with KM8A, KM8B, KM9A, KM9B it does not allow the assembly of the stop light kit or the remote control device on the case / it is not compatible with the original side-case holder	
	<b>KL166</b>	Specific pannier holder for <b>MONOKEY</b> ® side-cases not compatible with the side-cases in aluminium KVE37 K-venture	
	<b>KLXR166</b>	Specific rapid release side-case holder for K33 <b>MONOKEY</b> ® <b>SIDE</b> cases	
	<b>KLX166</b>	Specific pannier holder for K33 <b>MONOKEY</b> ® <b>SIDE</b> cases	
	<b>BF03K</b>	Specific flange for fitting the tank bags with TANKLOCK system	
<b>HONDA VFR 800 F (14 → 18)</b>			
	<b>KZ1132</b>	Specific rear rack for <b>MONOKEY</b> ® or <b>MONOLOCK</b> ® top-case to be combined with the <b>MONOKEY</b> ® KM5, KM7 plate, or with the <b>MONOLOCK</b> ® KM5M or KM6M plate / maximum load allowed 6 kg	
	<b>KLXR1132</b>	Specific rapid release side-case holder for K33 <b>MONOKEY</b> ® <b>SIDE</b> cases it can be mounted without the specific rear rack 1132FZ using the 1132KITK	
	<b>1132KITK</b>	Specific kit to install the KLXR1132 without the specific rear rack KZ1132	

CODICE	DESCRIZIONE	PRICE
 <b>BF20K</b>	Specific flange for fitting the tank bags with TANKLOCK system	
 <b>KD1132S</b>	Specific screen, smoked 48,2 x 36,5 cm (H x W) <i>to be mounted instead of the original screen / 8 cm higher than the original</i>	
<b>VARIOUS ACCESSORIES</b> <b>01SKITK</b>	Specific kit to mounting the KS900A Smart Bar	
<b>HONDA CB 900 HORNET (02 → 07)</b>		
 <b>KZ256</b>	Specific rear rack for <b>MONOKEY®</b> or <b>MONOLOCK®</b> top-case <i>to be combined with the MONOKEY® KM5, KM7, KM8A, KM8B, KM9A or KM9B plate, or with the MONOLOCK® KM5M or KM6M plate / if combined with KM8A, KM8B, KM9A, KM9B it does not allow the assembly of the stop light kit or the remote control device on the case / Bronze colour</i>	
 <b>240AK</b>	Universal screen, smoked 33 x 36,5 cm (H x W) <i>only available if article A257A is already fitted</i>	
<b>HONDA CB 1000 R (08 → 17)</b>		
 <b>KZ266</b>	Specific rear rack for <b>MONOKEY®</b> or <b>MONOLOCK®</b> top-case <i>to be combined with the MONOKEY® KM5, KM7, KM8A, KM8B, KM9A or KM9B plate, or with the MONOLOCK® KM5M or KM6M plate / if combined with KM8A, KM8B, KM9A, KM9B it does not allow the assembly of the stop light kit or the remote control device on the case</i>	
 <b>TE1101K</b>	Specific holder for soft side bags or for semi-rigid side bags (RA314) <i>it can be mounted without the specific rear rack KZ266 using the 1101KIT</i>	
 <b>BF03K</b>	Specific flange for fitting the tank bags with TANKLOCK system	
 <b>247AK</b>	Universal screen, smoked 29 x 28,5 cm (H x W) <i>from year '11 / only available if article A1101A is already fitted</i>	
<b>247NK</b>	Specific screen, black 29 x 28,5 cm (H x W) <i>only for CB 1000 R (11 &gt; 14) / only available if article A1101A is already fitted</i>	
<b>VARIOUS ACCESSORIES</b> <b>04SKITK</b>	Specific kit to mounting the KS900A Smart Bar	
<b>HONDA CB 1000 R (18) <span style="background-color: orange; color: white; padding: 2px;">NEW</span></b>		
 <b>KZ1165</b>	Specific rear rack for <b>MONOKEY®</b> or <b>MONOLOCK®</b> top-case <i>to be combined with the MONOKEY® KM5, KM7, KM8A, KM8B, KM9A or KM9B plate, or with the MONOLOCK® KM5M or KM6M plate / if combined with KM8A, KM8B, KM9A, KM9B it does not allow the assembly of the stop light kit or the remote control device on the case / we recommend fitting by a qualified mechanic / it is necessary to move the indicators from their original position</i>	
 <b>TE1165K</b>	Specific holder for soft side bags or for semi-rigid side bags (RA314) <i>it can be mounted without the specific rear rack KZ1165 using the 1165KITK / it is necessary to move the indicators from their original position</i>	
<b>1165KITK</b>	Specific kit to install the TE1165K without the specific rear rack KZ1165 <i>we recommend fitting by a qualified mechanic</i>	
 <b>BF38K</b>	Specific flange for fitting the tank bags with TANKLOCK system	
 <b>KA1165</b>	Specific screen, smoked 22 x 31 cm (H x W) <i>complete with specific fitting kit</i>	
 <b>KPR1165</b>	Stainless steel specific radiator guard black painted	
<b>VARIOUS ACCESSORIES</b> <b>01SKITK</b>	Specific kit to mounting the KS900A Smart Bar	
<b>HONDA CBF 1000 / ABS (06 → 09)</b>		
 <b>KZ260</b>	Specific rear rack for <b>MONOKEY®</b> or <b>MONOLOCK®</b> top-case <i>to be combined with the MONOKEY® KM5, KM8A, KM8B, KM9A or KM9B plate, or with the MONOLOCK® KM5M or KM6M plate / if combined with KM8A, KM8B, KM9A, KM9B it does not allow the assembly of the stop light kit or the remote control device on the case / It is not compatible with the original side-case holder</i>	
 <b>KL174</b>	Specific pannier holder for <b>MONOKEY®</b> side-cases <i>not compatible with the side-cases in aluminium KVE37 K-venture</i>	
<b>KLXR174</b>	Specific rapid release side-case holder for K33 <b>MONOKEY® SIDE</b> cases	
<b>KLX174</b>	Specific pannier holder for K33 <b>MONOKEY® SIDE</b> cases <i>it can be mounted without the specific rear rack KZ260 using the PLX174KIT</i>	
<b>KLX174KIT</b>	Specific kit to install the KLX without the rack for the top-case	
 <b>TK218</b>	Specific holder for soft side bags	



CODICE	DESCRIZIONE	PREZZO
 <b>BF03K</b>	Specific flange for fitting the tank bags with TANKLOCK system	
 <b>KD303ST</b>	Specific screen, transparent 54 x 39,5 cm (H x W) <i>to be mounted instead of the original screen / 12,5 cm higher than original</i>	
 <b>KN452</b>	Specific engine guard <i>25 mm diameter steel tube / we recommend fitting by a qualified mechanic</i>	
<b>HONDA CBF 1000 / CBF 1000 ST (10 → 14)</b>		
 <b>KR777</b>	Specific rear rack for <b>MONOKEY</b> ® top-case <b>MONOKEY</b> ® plate included / you must remove the grabrails, they are reproduced by the rack itself / is compatible with the original side-case holder	
<b>KR777M</b>	Specific rear rack for <b>MONOLOCK</b> ® top-case <b>MONOLOCK</b> ® plate included / you must remove the grabrails, they are reproduced by the rack itself / is compatible with the original side-case holder	
 <b>KL208</b>	Specific pannier holder for <b>MONOKEY</b> ®, RETRO FIT side-cases <i>it can be mounted only with the specific rear rack KR777 / KR777M or 777KIT</i>	
<b>KLXR208</b>	Specific rapid release side-case holder for K33 <b>MONOKEY</b> ® SIDE cases <i>it can be mounted only with the specific rear rack KR777 / KR777M or 777KIT</i>	
 <b>BF03K</b>	Specific flange for fitting the tank bags with TANKLOCK system	
 <b>KD320ST</b>	Specific screen, transparent 49 x 42,5 cm (H x W) <i>to be mounted instead of the original screen / 15 cm higher than the original / adjustable as the original</i>	
 <b>KN460</b>	Specific engine guard <i>25 mm diameter steel tube / we recommend fitting by a qualified mechanic</i>	
<b>VARIOUS ACCESSORIES</b> <b>02SKITK</b>	Specific kit to mounting the KS900A Smart Bar	
<b>HONDA CBR 1000 F (89 → 92)</b>		
 <b>K2270</b>	Specific rear rack for <b>MONOKEY</b> ® or <b>MONOLOCK</b> ® top-case <i>To be combined with the plate <b>MONOKEY</b>® K553N, or with the plate <b>MONOLOCK</b>® MKN</i>	
<b>HONDA CBR 1000 F (93 → 00)</b>		
 <b>K2270</b>	Specific rear rack for <b>MONOKEY</b> ® or <b>MONOLOCK</b> ® top-case <i>To be combined with the plate <b>MONOKEY</b>® K553N, or with the plate <b>MONOLOCK</b>® MKN</i>	
<b>HONDA CBR 1000 RR (06 → 07)</b>		
 <b>D308SPK</b>	Protective deflector <i>It must be installed on the original spoiler to increase the protection.</i>	
<b>HONDA CBR 1000 RR (08 → 09)</b>		
 <b>BF03K</b>	Specific flange for fitting the tank bags with TANKLOCK system	
<b>HONDA CBR 1000 RR (12 → 13)</b>		
 <b>BF03K</b>	Specific flange for fitting the tank bags with TANKLOCK system	
<b>HONDA CBR 1000 RR (17 → 18) <b>NEW</b></b>		
 <b>BF30K</b>	Specific flange for fitting the tank bags with TANKLOCK system	
<b>HONDA VTR 1000 F (97 → 04)</b>		
 <b>K2510</b>	Specific rear rack for <b>MONOKEY</b> ® or <b>MONOLOCK</b> ® top-case <i>To be combined with the plate <b>MONOKEY</b>® K553N, or with the plate <b>MONOLOCK</b>® MKN</i>	

→ CODICE	DESCRIZIONE	PRICE
-------------	-------------	-------

## HONDA CRF1000L AFRICA TWIN (16 → 17)

	<b>KR1144</b>	Specific rear rack for <b>MONOLOCK®</b> or <b>MONOKEY®</b> top-case to be combined with the <b>MONOKEY®</b> KM5, KM7, KM8A, KM8B, KM9A or KM9B plate, or with the <b>MONOLOCK®</b> KM5M or KM6M plate / if combined with KM8A, KM8B, KM9A, KM9B it does not allow the assembly of the stop light kit or the remote control device on the case
	<b>KLR1144</b>	Specific rapid release side-case holder for <b>MONOKEY®</b> , RETRO FIT cases you must move the indicators from their original position
	<b>KD1144S</b>	Specific screen, smoked 47,5 x 35 cm (H x W) 2 cm higher than the original / to be mounted instead of the original screen
	<b>KD1144ST</b>	Specific screen, transparent 60 x 35 cm (H x W) 14,5 cm higher than the original / to be mounted instead of the original screen
	<b>KD1144B0</b>	Specific low and sports screen matt black 40 x 31 cm (H x W) to be mounted instead of the original screen
	<b>KAF1144</b>	Specific sliding wind-screen transparent, AIRSTREAM. Maximum height 63,5 cm (12 cm of extension) width 35 cm 18 cm higher than the original / to be mounted instead of the original screen
	<b>KN1144</b>	Specific engine guard, black Not compatible with CRF1000L Africa Twin DCT / 25 mm diameter steel tube / we recommend fitting by a qualified mechanic
	<b>KNH1144</b>	Specific engine guard, black it must be mounted with KN1144, KN1144OX, KN1162, KN1162OX, KN1151 or KN1151OX / 25 mm diameter steel tube / we recommend fitting by a qualified mechanic / it protects the upper part of the radiators
	<b>KN1144OX</b>	Specific engine guard, stainless steel Not compatible with CRF1000L Africa Twin DCT / 25 mm diameter steel tube / we recommend fitting by a qualified mechanic
	<b>KNH1144OX</b>	Specific engine guard, stainless steel it must be mounted with KN1144, KN1144OX, KN1162, KN1162OX, KN1151 or KN1151OX / 25 mm diameter steel tube / we recommend fitting by a qualified mechanic / it protects the upper part of the radiators
	<b>KN1151</b> ↘	Specific engine guard, black Only for CRF1000L Africa Twin DCT / 25 mm diameter steel tube / we recommend fitting by a qualified mechanic
	<b>KN1151OX</b> ↘	Specific engine guard, stainless steel Only for CRF1000L Africa Twin DCT / 25 mm diameter steel tube / we recommend fitting by a qualified mechanic
	<b>KN1162</b>	Specific engine guard, black Only for CRF1000L Africa Twin DCT / 25 mm diameter steel tube / we recommend fitting by a qualified mechanic
	<b>KN1162OX</b>	Specific engine guard, stainless steel Only for CRF1000L Africa Twin DCT / 25 mm diameter steel tube / we recommend fitting by a qualified mechanic
	<b>RP1144K</b>	Oil carter protector in Aluminium thickness of 5 mm
	<b>RP1144KITK</b>	Specific kit to install RP1144K on the version produced without an original oil carter protector to be combined with RP1144
	<b>RP1162K</b>	Oil carter protector in Aluminium thickness of 5 mm
<b>VARIOUS ACCESSORIES</b>	<b>KS281</b>	Pair of stainless steel universal manifold protectors. Suitable for motorcycles with manifold diameters between 42 mm and 52 mm.
	<b>KHP1144</b>	Specific hands protector in ABS only compatible with the version produced with original hands protector / to be mounted instead of the original hands protector
	<b>ES1144K</b>	Specific support in aluminium and stainless steel to widen the surface support area of the original side stand
	<b>03SKITK</b>	Specific kit to mounting the KS900A Smart Bar

## HONDA CRF1000L AFRICA TWIN (18) **NEW**















	<b>KR1162</b>	Specific rear rack for <b>MONOLOCK®</b> or <b>MONOKEY®</b> top-case to be combined with the <b>MONOKEY®</b> KM5, KM7, KM8A, KM8B, KM9A or KM9B plate, or with the <b>MONOLOCK®</b> KM5M or KM6M plate / if combined with KM8A, KM8B, KM9A, KM9B it does not allow the assembly of the stop light kit or the remote control device on the case
	<b>KLR1161</b>	Specific rapid release side-case holder for <b>MONOKEY®</b> , RETRO FIT cases it can be mounted without the specific rear rack KR1162 using the 1161KITK
	<b>1161KITK</b>	Specific kit to install the KLR1161 without the specific rear rack KR1161
	<b>KTL1161KIT</b>	Specific kit to install the KS250 Tool Box on KLR1161 to be combined with KS250 and KLR1161 / needs to be mounted on the left-hand side of the motorcycle
	<b>KD1144S</b>	Specific screen, smoked 47,5 x 35 cm (H x W) 2 cm higher than the original / to be mounted instead of the original screen
	<b>KD1144ST</b>	Specific screen, transparent 60 x 35 cm (H x W) 14,5 cm higher than the original / to be mounted instead of the original screen
	<b>KD1144B0</b>	Specific low and sports screen matt black 40 x 31 cm (H x W) to be mounted instead of the original screen
	<b>KAF1144</b>	Specific sliding wind-screen transparent, AIRSTREAM. Maximum height 63,5 cm (12 cm of extension) width 35 cm 18 cm higher than the original / to be mounted instead of the original screen























CODICE	DESCRIZIONE	PREZZO
 <b>KN1144</b>	Specific engine guard, black <i>25 mm diameter steel tube / we recommend fitting by a qualified mechanic</i>	
<b>KNH1144</b>	Specific engine guard, black <i>it must be mounted with KN1144, KN1144OX, KN1162, KN1162OX / 25 mm diameter steel tube / we recommend fitting by a qualified mechanic / it protects the upper part of the radiators</i>	
<b>KN1144OX</b>	Specific engine guard, stainless steel <i>25 mm diameter steel tube / we recommend fitting by a qualified mechanic</i>	
<b>KNH1144OX</b>	Specific engine guard, stainless steel <i>it must be mounted with KN1144, KN1144OX, KN1162, KN1162OX / 25 mm diameter steel tube / we recommend fitting by a qualified mechanic / it protects the upper part of the radiators</i>	
<b>KN1162</b>	Specific engine guard, black <i>only for CRF1000L Africa Twin DCT / 25 mm diameter steel tube / we recommend fitting by a qualified mechanic</i>	
<b>KN1162OX</b>	Specific engine guard, stainless steel <i>only for CRF1000L Africa Twin DCT / 25 mm diameter steel tube / we recommend fitting by a qualified mechanic</i>	
<b>RP1162K</b>	Oil carter protector in Aluminium <i>thickness of 5 mm</i>	
<b>VARIOUS ACCESSORIES</b> <b>KS281</b>	Pair of stainless steel universal manifold protectors. Suitable for motorcycles with manifold diameters between 42 mm and 52 mm.	
<b>KHP1144</b>	Specific hands protector in ABS <i>only compatible with the version produced with original hands protector / to be mounted instead of the original hands protector</i>	
<b>ES1161K</b>	Specific support in aluminium and stainless steel to widen the surface support area of the original side stand	
<b>03SKITK</b>	Specific kit to mounting the KS900A Smart Bar	
<b>HONDA CRF1000L AFRICA TWIN ADVENTURE SPORTS (18) <span style="background-color: orange; color: white; padding: 2px;">NEW</span></b>		
 <b>KR1161</b>	Specific rear rack for <b>MONOLOCK®</b> or <b>MONOKEY®</b> top-case <i>to be combined with the MONOKEY® KM5, KM7, KM8A, KM8B, KM9A or KM9B plate, or with the MONOLOCK® KM5M or KM6M plate / if combined with KM8A, KM8B, KM9A, KM9B it does not allow the assembly of the stop light kit or the remote control device on the case</i>	
 <b>KLR1161</b>	Specific rapid release side-case holder for <b>MONOKEY®</b> , RETRO FIT cases <i>it can be mounted without the specific rear rack KR1161 using the 1161KITK</i>	
<b>1161KITK</b>	Specific kit to install the KLR1161 without the specific rear rack KR1161	
<b>KTL1161KIT</b>	Specific kit to install the KS250 Tool Box on KLR1161 <i>to be combined with KS250 and KLR1161 / needs to be mounted on the left-hand side of the motorcycle</i>	
 <b>KD1144S</b>	Specific screen, smoked 47,5 x 35 cm (H x W) <i>to be mounted instead of the original screen</i>	
<b>KD1144ST</b>	Specific screen, transparent 60 x 35 cm (H x W) <i>7 cm higher than the original / to be mounted instead of the original screen</i>	
<b>KD1144BO</b>	Specific low and sports screen matt black 40 x 31 cm (H x W) <i>to be mounted instead of the original screen</i>	
<b>KAF1144</b>	Specific sliding wind-screen transparent, AIRSTREAM. Maximum height 63,5 cm (12 cm of extension) width 35 cm <i>18 cm higher than the original / to be mounted instead of the original screen</i>	
 <b>KN1161OX</b>	Specific engine guard, stainless steel <i>not compatible with DCT / 25 mm diameter steel tube / we recommend fitting by a qualified mechanic</i>	
<b>KN1167OX</b>	Specific engine guard, stainless steel <i>only compatible with the version DCT / 25 mm diameter steel tube / we recommend fitting by a qualified mechanic</i>	
<b>VARIOUS ACCESSORIES</b> <b>KS281</b>	Pair of stainless steel universal manifold protectors. Suitable for motorcycles with manifold diameters between 42 mm and 52 mm.	
<b>LS11610XK</b>	Specific fitting kit to mount KS310 or KS322 spotlights, using the threads of the original crash bars located on the sides of the fairing	
<b>KHP1144</b>	Specific hands protector in ABS <i>only compatible with the version produced with original hands protector / to be mounted instead of the original hands protector</i>	
<b>ES1161K</b>	Specific support in aluminium and stainless steel to widen the surface support area of the original side stand	
<b>03SKITK</b>	Specific kit to mounting the KS900A Smart Bar	
<b>HONDA XL 1000 V VARADERO (99 → 02)</b>		
 <b>K212</b>	Specific rear rack for <b>MONOKEY®</b> top-case <b>MONOKEY®</b> plate included	
 <b>KL164</b>	Specific pannier holder for <b>MONOKEY®</b> , RETRO FIT side-cases	
 <b>KD203S</b>	Specific screen, smoked 62,4 x 55 cm (H x W) <i>to be mounted instead of the original screen</i>	
 <b>KN25</b>	Specific engine guard <i>25 mm diameter steel tube / we recommend fitting by a qualified mechanic / black colour</i>	















CODICE	DESCRIZIONE	PRICE
<b>HONDA XL 1000 V VARADERO / ABS (03 → 06)</b>		
 <b>K212</b>	Specific rear rack for <b>MONOKEY</b> ® top-case <b>MONOKEY</b> ® plate included	
 <b>KL170</b>	Specific pannier holder for <b>MONOKEY</b> ®, RETRO FIT side-cases	
 <b>KD300ST</b>	Specific screen, transparent 60 x 48 cm (H x W) <i>9 cm higher than the original</i>	
<b>KD300S</b>	Specific screen, smoked 60 x 48 cm (H x W) <i>to be mounted instead of the original screen / 9 cm higher than the original</i>	
 <b>KN28</b>	Specific engine guard <i>25 mm diameter steel tube / we recommend fitting by a qualified mechanic / colour black.</i>	
<b>HONDA XL 1000 V VARADERO / ABS (07 → 12)</b>		
 <b>K222</b>	Specific rear rack for <b>MONOKEY</b> ® top-case <b>MONOKEY</b> ® plate included	
 <b>KL177</b>	Specific pannier holder for <b>MONOKEY</b> ®, RETRO FIT side-cases	
<b>KLX177</b>	Specific pannier holder for K33 <b>MONOKEY</b> ® SIDE cases	
 <b>KD300S</b>	Specific screen, smoked 60 x 48 cm (H x W) <i>to be mounted instead of the original screen / 9 cm higher than the original</i>	
<b>KD300ST</b>	Specific screen, transparent 60 x 48 cm (H x W) <i>9 cm higher than the original</i>	
 <b>KN454</b>	Specific engine guard <i>25 mm diameter steel tube / we recommend fitting by a qualified mechanic</i>	
<b>HONDA CB 1100 (13 → 14)</b>		
 <b>KR1118</b>	Specific rear chromed rack for <b>MONOLOCK</b> ® or <b>MONOKEY</b> ® top-case <i>to be combined with the K636 <b>MONOKEY</b>® plate (sold separately), or with the plate already included in the <b>MONOLOCK</b>® top-cases</i>	
<b>VARIOUS ACCESSORIES 01SKITK</b>	Specific kit to mounting the KS900A Smart Bar	
<b>HONDA CBR 1100 XX (97 → 09)</b>		
 <b>K2480</b>	Specific rear rack for <b>MONOKEY</b> ® or <b>MONOLOCK</b> ® top-case <i>To be combined with the plate <b>MONOKEY</b>® K553N, or with the plate <b>MONOLOCK</b>® MKN</i>	
 <b>K8158</b>	Specific wingrack fitting kit <i>It can be combined only with the chassis K140</i>	
<b>HONDA ST 1100 PAN EUROPEAN</b>		
 <b>K109</b>	Specific rear rack for <b>MONOKEY</b> ® top-case <b>MONOKEY</b> ® plate included	
<b>HONDA CROSSTOURER 1200 / CROSSTOURER 1200 DCT (12 → 18)</b>		
 <b>KR1110</b>	Specific rear rack for <b>MONOKEY</b> ® top-case <i>maximum load allowed 6 kg / <b>MONOKEY</b>® plate included</i>	
<b>KRA1110</b>	Specific rear rack in aluminium for <b>MONOKEY</b> ® top-case <i>maximum load allowed 6kg / it does not allow the assembly of the stop light kit or the remote control device on the case / to be mounted on the original case carrier</i>	
 <b>KLR1110</b>	Specific rapid release side-case holder for <b>MONOKEY</b> ®, RETRO FIT cases	
<b>KLXR1110</b>	Specific rapid release side-case holder for K33 <b>MONOKEY</b> ® SIDE cases	
 <b>BF03K</b>	Specific flange for fitting the tank bags with TANKLOCK system <i>compatible from 12 to 13</i>	
<b>BF20K</b>	Specific flange for fitting the tank bags with TANKLOCK system <i>from 2014 onwards</i>	
 <b>KD1110ST</b>	Specific screen, transparent 51 x 42 cm (H x W) <i>compatible from 12 to 15 / to be mounted instead of the original screen / 19 cm higher than the original wind-screen</i>	
<b>VARIOUS ACCESSORIES EH1110K</b>	Plexiglass extension for original hands protector, smoked <i>compatible from 12 to 16</i>	
 <b>KN1110</b>	Specific engine guard <i>25 mm diameter steel tube / we recommend fitting by a qualified mechanic</i>	

CODICE	DESCRIZIONE	PREZZO
<b>RP1141K</b>	Oil carter protector in Aluminium <i>only for Crosstourer 1200 DCT</i>	
<b>VARIOUS ACCESSORIES</b> <b>ES1110K</b>	Specific support in aluminium and stainless steel to widen the surface support area of the original side stand	
<b>03SKITK</b>	Specific kit to mounting the KS900A Smart Bar	
<b>HONDA</b>		
<b>VFR 1200 F (10 → 16)</b>		
	Specific rear rack for <b>MONOKEY®</b> or <b>MONOLOCK®</b> top-case <i>to be combined with the MONOKEY® KM5, KM7, KM8A, KM8B, KM9A or KM9B plate, or with the MONOLOCK® KM5M or KM6M plate / if combined with KM8A, KM8B, KM9A, KM9B it does not allow the assembly of the stop light kit or the remote control device on the case / in order to fit it you must remove the handle bar of the scooter / it is compatible with the original side-case holder</i>	
 <b>KZ267</b>		
 <b>BF03K</b>	Specific flange for fitting the tank bags with TANKLOCK system	
 <b>KD321S</b>	Specific screen, smoked 40 x 40 cm (H x W) <i>to be mounted instead of the original screen / 14 cm higher than original</i>	
<b>HONDA</b>		
<b>CB 1300 / CB 1300 S (03 → 09)</b>		
	Specific rear rack for <b>MONOKEY®</b> or <b>MONOLOCK®</b> top-case <i>to be combined with the MONOKEY® KM5, KM7, KM8A, KM8B, KM9A or KM9B plate, or with the MONOLOCK® KM5M or KM6M plate / if combined with KM8A, KM8B, KM9A, KM9B it does not allow the assembly of the stop light kit or the remote control device on the case</i>	
 <b>KZ259</b>		
 <b>KN451</b>	Specific engine guard <i>25 mm diameter steel tube / we recommend fitting by a qualified mechanic</i>	
<b>HONDA</b>		
<b>CB 1300 S (10 → 15)</b>		
	Specific rear rack for <b>MONOKEY®</b> or <b>MONOLOCK®</b> top-case <i>to be combined with the MONOKEY® KM5, KM7, KM8A, KM8B, KM9A or KM9B plate, or with the MONOLOCK® KM5M or KM6M plate / if combined with KM8A, KM8B, KM9A, KM9B it does not allow the assembly of the stop light kit or the remote control device on the case</i>	
 <b>KZ268</b>		
 <b>BF03K</b>	Specific flange for fitting the tank bags with TANKLOCK system	
 <b>KN451</b>	Specific engine guard <i>25 mm diameter steel tube / we recommend fitting by a qualified mechanic</i>	
<b>HONDA</b>		
<b>CTX 1300 (14 → 16)</b>		
	Specific rear rack for <b>MONOKEY®</b> top-case <i>to be combined with the plate already included in the MONOKEY® top-case</i>	
 <b>KR1134</b>		
 <b>KD1134ST</b>	Specific screen, transparent, transparent, 51,5 x 65 cm (h x w) <i>to be mounted instead of the original screen</i>	
<b>VARIOUS ACCESSORIES</b> <b>01SKITK</b>	Specific kit to mounting the KS900A Smart Bar	
<b>HONDA</b>		
<b>PAN EUROPEAN ST 1300 (02 → 14)</b>		
 <b>K215</b>	Specific rear rack for <b>MONOKEY®</b> top-case <i>It has to be fitted on the original luggage carrier</i>	
<b>KAWASAKI</b>		
<b>Z 125 (19) NEW</b>		
 <b>BF42K</b>	Specific flange for fitting the tank bags with TANKLOCK system	
 <b>4125SK</b>	Specific screen, smoked 27,5 x 33,5 cm (H x W) <i>to be combined with the specific A4125AK fitting kit</i>	
<b>4125GRK</b>	Specific screen, "LIME" 27,5 x 33,5 cm (H x W) <i>to be combined with the specific A4125AK fitting kit / when illuminated by vehicle headlights in low light conditions, the edge glows green in colour</i>	
<b>A4125AK</b>	Specific fitting kit for 4125SK, 4125GRK	



CODICE	DESCRIZIONE	PRICE
<b>KAWASAKI NINJA 250 R (08 → 12)</b>		
 <b>TE4107K</b> ↘	Specific holder for soft side bags or for semi-rigid side bags (RA314) <i>it can be mounted without the specific rear rack KZ4107 using the 4107KITK</i>	
<b>4107KITK</b> ↘	Specific kit to install the TE4107K without the specific rear rack KZ4107	
 <b>KD4107S</b> ↘	Specific screen, smoked 46 x 31 cm (H x W) <i>to be mounted instead of the original screen / 12 cm higher than original</i>	
<b>KAWASAKI NINJA 300 (13 → 18)</b>		
 <b>KZ4108</b>	Specific rear rack for <b>MONOKEY®</b> or <b>MONOLOCK®</b> top-case <i>to be combined with the MONOKEY® KM5, KM7, KM8A, KM8B, KM9A or KM9B plate, or with the MONOLOCK® KM5M or KM6M plate / if combined with KM8A, KM8B, KM9A, KM9B it does not allow the assembly of the stop light kit or the remote control device on the case / maximum load allowed 6 kg</i>	
 <b>TE4108K</b>	Specific holder for soft side bags or for semi-rigid side bags (RA314) <i>it can be mounted without the specific rear rack 4108FZ using the 4108KITK</i>	
<b>4108KITK</b>	Specific kit to install the TE4108K without the specific rear rack KZ4108	
 <b>BF14K</b>	Specific flange for fitting the tank bags with TANKLOCK system	
 <b>KD4108S</b>	Specific screen, smoked 42 x 34 cm (H x W) <i>to be mounted instead of the original screen / 9 cm higher than original</i>	
<b>KAWASAKI J 125 - J 300 (14 → 18)</b>		
 <b>KR4111</b>	Specific rear rack for <b>MONOKEY®</b> top-case <b>MONOKEY®</b> plate included	
<b>KR4111MM</b>	Specific rear rack for <b>MONOLOCK®</b> top-case <b>MONOLOCK®</b> plate with place for the "u" type padlock included	
 <b>4111DTK</b>	Specific screen, transparent 79.5 x 65 cm (H x W) <i>to be combined with the specific D4111KITK fitting kit</i>	
<b>D4111KITK</b>	Specific fitting kit for 4111DTK	
<b>KAWASAKI Z 300 (15 → 16)</b>		
 <b>KZ4116</b>	Specific rear rack for <b>MONOKEY®</b> or <b>MONOLOCK®</b> top-case <i>to be combined with the MONOKEY® KM5, KM7, KM8A, KM8B, KM9A or KM9B plate, or with the MONOLOCK® KM5M or KM6M plate / if combined with KM8A, KM8B, KM9A, KM9B it does not allow the assembly of the stop light kit or the remote control device on the case / maximum load allowed 6 kg</i>	
 <b>05SKITK</b>	Specific kit to mounting the KS900A Smart Bar	
<b>KAWASAKI VERSYS-X 300 (17 → 18)</b>		
 <b>K636</b>	Universal <b>MONOKEY®</b> plate with fitting kit to fit a case on a scooter already with a rack	
 <b>KL4121</b>	Specific pannier holder for <b>MONOKEY®</b> , RETRO FIT side-cases	
<b>KTL4121KIT</b>	Specific kit to install the KS250 Tool Box on KL4121 <i>to be combined with KS250 and KL4121 / it can be mounted on either the right-hand side or left-hand side of the motorcycle</i>	
 <b>BF29K</b>	Specific flange for fitting the tank bags with TANKLOCK system	
 <b>KD4121ST</b>	Specific screen, transparent 48 x 40 cm (H x W) <i>to be mounted instead of the original screen / 14 cm higher than the original</i>	
<b>KD4121GR</b>	Specific "LIME" screen, 41 x 40 cm (H x W) <i>to be mounted instead of the original screen / when illuminated by vehicle headlights in low light conditions, the edge glows green in colour / 7 cm higher than the original</i>	
 <b>KN4121</b>	Specific engine guard, black <i>25 mm diameter steel tube / we recommend fitting by a qualified mechanic</i>	
 <b>KHP4121</b>	Specific hands protector in ABS	
<b>ES4121K</b>	Specific support in aluminium and stainless steel to widen the surface support area of the original side stand	
<b>02SKITK</b>	Specific kit to mounting the KS900A Smart Bar	

CODICE	DESCRIZIONE	PREZZO
<b>KAWASAKI ER 5 500 (98 → 00)</b>		
 <b>K4320</b>	Specific rear rack for <b>MONOKEY®</b> or <b>MONOLOCK®</b> top-case <i>To be combined with the plate <b>MONOKEY®</b> K553N, or with the plate <b>MONOLOCK®</b> MKN</i>	
<b>KAWASAKI ER 5 500 (01 → 07)</b>		
 <b>K4400</b>	Specific rear rack for <b>MONOKEY®</b> or <b>MONOLOCK®</b> top-case <i>To be combined with the plate <b>MONOKEY®</b> K553N, or with the plate <b>MONOLOCK®</b> MKN</i>	
<b>KAWASAKI KLE 500 (91 → 93)</b>		
 <b>05SKITK</b>	Specific kit to mounting the KS900A Smart Bar	
<b>KAWASAKI KLE 500 (94 → 04)</b>		
 <b>05SKITK</b>	Specific kit to mounting the KS900A Smart Bar <i>compatible from 1994 to 2000</i>	
<b>KAWASAKI ER 6N / ER 6F 650 (05 → 08)</b>		
 <b>KZ445</b>	Specific rear rack for <b>MONOLOCK®</b> top-case <i>maximum load allowed 6 kg / to be combined with the <b>MONOLOCK®</b> KM5M or KM6M plates</i>	
 <b>KLX445</b>	Specific pannier holder for K33 <b>MONOKEY®</b> <b>SIDE</b> cases <i>it can be mounted only with the specific rear rack KZ445 / you must move the indicators from their original position</i>	
 <b>TK262</b>	Specific holder for soft side bags	
 <b>BF04K</b>	Specific flange for fitting the tank bags with TANKLOCK system	
 <b>245NK</b>	Universal screen, black 33,5 x 29 cm (H x W) <i>only for ER-6N / only available if article A445A is already fitted</i>	
<b>KAWASAKI ER-6N / ER-6F 650 (09 → 11)</b>		
 <b>KZ449</b>	Specific rear rack for <b>MONOKEY®</b> or <b>MONOLOCK®</b> top-case <i>to be combined with the <b>MONOKEY®</b> KM5, KM7, KM8A, KM8B, KM9A or KM9B plate, or with the <b>MONOLOCK®</b> KM5M or KM6M plate / if combined with KM8A, KM8B, KM9A, KM9B it does not allow the assembly of the stop light kit or the remote control device on the case / you need to remove the handle bar of the scooter to install it</i>	
 <b>KLX449</b>	Specific pannier holder for K33 <b>MONOKEY®</b> <b>SIDE</b> cases <i>it can be mounted only with the specific rear rack KZ449 / you must remove the original grabrails</i>	
 <b>TE266K</b>	Telaietti specifici per borse laterali soffici o per borse laterali semirigide RA314	
 <b>BF04K</b>	Specific flange for fitting the tank bags with TANKLOCK system	
 <b>247NK</b>	Specific screen, black 29 x 28,5 cm (H x W) <i>only for ER-6N / to be combined with the specific A448A fitting kit</i>	
 <b>03SKITK</b>	Specific kit to mounting the KS900A Smart Bar	
<b>KAWASAKI ER-6N / ER-6F 650 (12 → 16)</b>		
 <b>KZ4104</b>	Specific rear rack for <b>MONOKEY®</b> or <b>MONOLOCK®</b> top-case <i>to be combined with the <b>MONOKEY®</b> KM5, KM7, KM8A, KM8B, KM9A or KM9B plate, or with the <b>MONOLOCK®</b> KM5M or KM6M plate / if combined with KM8A, KM8B, KM9A, KM9B it does not allow the assembly of the stop light kit or the remote control device on the case / black colour</i>	
 <b>KLX4104</b>	Specific pannier holder for K33 <b>MONOKEY®</b> <b>SIDE</b> cases	
 <b>TE4104K</b>	Specific holder for soft side bags or for semi-rigid side bags (RA314)	
 <b>BF04K</b>	Specific flange for fitting the tank bags with TANKLOCK system	
 <b>KA4104</b>	Specific screen, smoked 32 x 30 cm (H x W) <i>only for version ER-6FN / complete with fitting kit</i>	
 <b>KD4104S</b>	Specific screen, smoked 50 x 40 cm (H x W) <i>only for ER-6F / to be mounted instead of the original screen / 10 cm higher than original</i>	
 <b>03SKITK</b>	Specific kit to mounting the KS900A Smart Bar <i>only for version ER-6F</i>	

CODICE	DESCRIZIONE	PRICE
<b>KAWASAKI ZZR 600 (93 → 01)</b>		
 <b>K4230</b>	Specific rear rack for <b>MONOKEY</b> ® or <b>MONOLOCK</b> ® top-case <i>To be combined with the plate <b>MONOKEY</b>® K553N, or with the plate <b>MONOLOCK</b>® MKN</i>	
<b>KAWASAKI ZX-6R (09 → 12)</b>		
 <b>BF04K</b>	Specific flange for fitting the tank bags with TANKLOCK system	
<b>KAWASAKI KLR 650 ENDURO (07 → 18)</b>		
 <b>K581</b>	Specific rear rack for <b>MONOKEY</b> ® top-case <b>MONOKEY</b> ® plate included	
<b>KE5810</b>	Specific rear rack for <b>MONOLOCK</b> ® top-case <i>to be combined with the plate already included in the <b>MONOLOCK</b>® top-case</i>	
 <b>KL448</b>	Specific pannier holder for <b>MONOKEY</b> ®, RETRO FIT side-cases	
 <b>408DK</b>	Specific screen, smoked 54 x 35 cm (H x W) <i>to be combined with the specific D408KITK fitting kit/ 23 cm higher than original</i>	
<b>D408KITK</b>	Specific fitting kit for 408DK	
 <b>KN421</b>	Specific engine guard <i>25 mm diameter steel tube / we recommend fitting by a qualified mechanic</i>	
<b>KAWASAKI VERSYS 650 (06 → 09)</b>		
 <b>KZ447</b>	Specific rear rack for <b>MONOKEY</b> ® or <b>MONOLOCK</b> ® top-case <i>to be combined with the <b>MONOKEY</b>® KM5, KM7, KM8A, KM8B, KM9A or KM9B plate, or with the <b>MONOLOCK</b>® KM5M or KM6M plate / if combined with KM8A, KM8B, KM9A, KM9B it does not allow the assembly of the stop light kit or the remote control device on the case / black colour / fitting kit included</i>	
 <b>KLX447</b> ↘	Specific pannier holder for K33 <b>MONOKEY</b> ® <b>SIDE</b> cases <i>it can be mounted without the specific rear rack KZ447 using the KLX447KIT / you must move the indicators from their original position</i>	
<b>KL447</b>	Specific pannier holder for <b>MONOKEY</b> ®, RETRO FIT side-cases <i>it can be mounted without the specific rear rack KZ447 using the KLX447KIT / the indicators must be moved from original position</i>	
<b>KLX447KIT</b>	Specific kit to install the KLX without the rack for the top-case	
 <b>KD405ST</b>	Specific screen, transparent 46 x 44,5 cm (H x W) <i>to be mounted instead of the original screen</i>	
<b>VARIOUS ACCESSORIES</b> <b>KMG4103</b>	Specific ABS mudguard, black colour	
<b>03SKITK</b>	Specific kit to mounting the KS900A Smart Bar	
<b>KAWASAKI VERSYS 650 (10 → 14)</b>		
 <b>KZ451</b>	Specific rear rack for <b>MONOKEY</b> ® or <b>MONOLOCK</b> ® top-case <i>to be combined with the <b>MONOKEY</b>® KM5, KM7, KM8A, KM8B, KM9A or KM9B plate, or with the <b>MONOLOCK</b>® KM5M or KM6M plate / if combined with KM8A, KM8B, KM9A, KM9B it does not allow the assembly of the stop light kit or the remote control device on the case</i>	
 <b>KLR450</b>	Specific rapid release side-case holder for <b>MONOKEY</b> ®, RETRO FIT cases <i>it can be mounted without the specific rear rack KZ451 using the 450KITK / you must move the indicators from their original position</i>	
<b>KLXR450</b> ↘	Specific rapid release side-case holder for K33 <b>MONOKEY</b> ® <b>SIDE</b> cases <i>can be mounted without the the specific rear rack using the 450KITK / you must move the indicators from their original position</i>	
<b>450KITK</b>	Specific kit to install the KLR450 and the KLXR450 without the specific rear rack KZ451	
 <b>TE4103K</b>	Specific holder for soft side bags or for semi-rigid side bags (RA314)	
 <b>BF04K</b>	Specific flange for fitting the tank bags with TANKLOCK system	
 <b>KD410ST</b>	Specific screen, transparent 48 x 37 cm (H x W) <i>to be mounted instead of the original screen / 21 cm higher than the original</i>	
 <b>KN422</b>	Specific engine guard <i>25 mm diameter steel tube / we recommend fitting by a qualified mechanic</i>	
<b>VARIOUS ACCESSORIES</b> <b>KMG4103</b>	Specific ABS mudguard, black colour	
<b>KHP4103</b>	Specific hands protector in ABS	

CODICE	DESCRIZIONE	PREZZO
--------	-------------	--------

**ES4103K** Specific support in aluminium and stainless steel to widen the surface support area of the original side stand

**03SKITK** Specific kit to mounting the KS900A Smart Bar

### KAWASAKI VERSYS 650 (15 → 18)



**KR4114** Specific rear rack for **MONOLOCK®** or **MONOKEY®** top-case to be combined with the **MONOKEY®** KM5, KM7, KM8A, KM8B, KM9A or KM9B plate, or with the **MONOLOCK®** KM5M or KM6M plate / if combined with KM8A, KM8B, KM9A, KM9B it does not allow the assembly of the stop light kit or the remote control device on the case



**KL4114** Specific pannier holder for **MONOKEY®**, RETRO FIT side-cases it can be mounted without the specific rear rack SR4114 using the 4114KITK / To ensure the best visibility of the rear indicators mounted with the cases, you need to relocate them by using kit IN4114KIT

**KLX4114** Specific pannier holder for K33 **MONOKEY®** SIDE cases it can be mounted without the specific rear rack KZ4114 using the 4114KITK / you must move the indicators from their original position

**4114KITK** Specific kit to install the KL4114 / KLX4114 / TE4114K without the specific rear rack KR4114



**TE4114K** Specific holder for soft side bags or for semi-rigid side bags (RA314)  
It can only be mounted with KR4114 or 4114KITK



**KD4114ST** Specific screen, transparent, 53 x 44 cm (H x W)  
compatible from '12 to '13 / to be mounted instead of the original screen

**KD4105ST** Specific screen, transparent 49 x 48 cm (H x W)  
compatible from '12 to '13 / to be mounted instead of the original screen / 16 cm higher than the original

**KD4122ST** Specific screen, transparent, 53 x 44 cm (H x W)  
compatible from '17 / to be mounted instead of the original screen

**KAF4105** Specific Airstream sliding wind-screen transparent. Maximum height 52 cm (12 cm of extension), width 48 cm  
compatible from '12 to '13 / complete with specific fitting kit / to be mounted instead of the original screen



**KN4114** Specific engine guard, black  
25 mm diameter steel tube / we recommend fitting by a qualified mechanic

**KPR4114** Stainless steel specific radiator guard black painted



**KMG4103** Specific ABS mudguard, black colour

**KRM01** Universal spray guard  
It needs to be paired with the specific mounting kit (RM3114KITK)

**KRM02** Universal spray guard  
It needs to be paired with the specific mounting kit (RM3114KITK)

**RM4114KITK** Specific kit for spray guard KRM01, KRM02

**LS4114K** Specific fitting kit to mount KS310 or KS322 spotlights where specific engine guard is not present

**KHP4103** Specific hands protector in ABS

**ES4103K** Specific support in aluminium and stainless steel to widen the surface support area of the original side stand

**KFB4114** Fairing upper bracket to be mounted behind the windshield to install KS920M, KS920L and GPS-Smartphone holder  
Compatible with the original windshield and the windshield KD4114ST / For KS920M, KS920L, KS952B, KS953B, KS954B, KS955B, KS956B, KS957B

**05SKITK** Specific kit to mounting the KS900A Smart Bar

### KAWASAKI VULCAN S 650 (15 → 18)



**KL4115** Specific pannier holder for **MONOKEY®**, RETRO FIT side-cases



**KTS4115B** Backrest with detachable small luggage carrier, black





















### KAWASAKI Z 650 (17 → 18)





































**KZ4117** Specific rear rack for **MONOKEY®** or **MONOLOCK®** top-case to be combined with the **MONOKEY®** KM5, KM7, KM8A, KM8B, KM9A or KM9B plate, or with the **MONOLOCK®** KM5M or KM6M plate / if combined with KM8A, KM8B, KM9A, KM9B it does not allow the assembly of the stop light kit or the remote control device on the case / maximum load allowed 6 kg

















**KLX4117** Specific pannier holder for K33 **MONOKEY®** SIDE cases

















CODICE	DESCRIZIONE	PRICE
 <b>TE4117K</b>	Specific holder for soft side bags or for semi-rigid side bags [RA314]	
 <b>BF28K</b>	Specific flange for fitting the tank bags with TANKLOCK system	
 <b>KA4117</b>	Specific screen, smoked 28 x 33 cm (H x W) <i>complete with specific fitting kit</i>	
<b>KA4117GR</b>	Specific "LIME" screen 28 x 33 cm (H x W) <i>complete with specific fitting kit / when illuminated by vehicle headlights in low light conditions, the edge glows green in colour</i>	
 <b>KPR4117</b>	Stainless steel specific radiator guard black painted	
<b>KAWASAKI</b>	<b>NINJA 650 (17 → 18)</b>	
 <b>KD4119S</b>	Specific screen, smoked 44,5 x 33,5 cm (H x W) <i>to be mounted instead of the original screen</i>	
<b>KAWASAKI</b>	<b>ZR 7 / ZR 7 S 750 (99 → 04)</b>	
 <b>K4360</b>	Specific rear rack for <b>MONOKEY</b> ® or <b>MONOLOCK</b> ® top-case <i>To be combined with the plate <b>MONOKEY</b>® K553N, or with the plate <b>MONOLOCK</b>® MKN</i>	
<b>KAWASAKI</b>	<b>Z 750 (03 → 06)</b>	
 <b>KZ443</b>	Specific rear rack for <b>MONOKEY</b> ® or <b>MONOLOCK</b> ® top-case <i>to be combined with the <b>MONOKEY</b>® KM5, KM7, KM8A, KM8B, KM9A or KM9B plate, or with the <b>MONOLOCK</b>® KM5M or KM6M plate / if combined with KM8A, KM8B, KM9A, KM9B it does not allow the assembly of the stop light kit or the remote control device on the case / maximum load allowed 6 kg</i>	
 <b>BF04K</b>	Specific flange for fitting the tank bags with TANKLOCK system	
 <b>05SKITK</b>	Specific kit to mounting the KS900A Smart Bar	
<b>KAWASAKI</b>	<b>Z 750 (07 → 14)</b>	
 <b>KZ448</b>	Specific rear rack for <b>MONOKEY</b> ® or <b>MONOLOCK</b> ® top-case <i>to be combined with the <b>MONOKEY</b>® KM5, KM7, KM8A, KM8B, KM9A or KM9B plate, or with the <b>MONOLOCK</b>® KM5M or KM6M plate / if combined with KM8A, KM8B, KM9A, KM9B it does not allow the assembly of the stop light kit or the remote control device on the case / maximum load allowed 6 kg / in order to install it you must reposition the indicators from their original position</i>	
 <b>TE265K</b>	Specific holder for soft side bags or for semi-rigid side bags [RA314] <i>it can be mounted without the specific rear rack KZ448 using the T265KIT / you must move the indicators from their original position</i>	
 <b>BF04K</b>	Specific flange for fitting the tank bags with TANKLOCK system	
 <b>05SKITK</b>	Specific kit to mounting the KS900A Smart Bar <i>also for version Z750R (11 &gt; 14)</i>	
<b>KAWASAKI</b>	<b>Z 750 S (05 → 07)</b>	
 <b>KZ444</b>	Specific rear rack for <b>MONOKEY</b> ® or <b>MONOLOCK</b> ® top-case <i>to be combined with the <b>MONOKEY</b>® KM5, KM7, KM8A, KM8B, KM9A or KM9B plate, or with the <b>MONOLOCK</b>® KM5M or KM6M plate / if combined with KM8A, KM8B, KM9A, KM9B it does not allow the assembly of the stop light kit or the remote control device on the case / maximum load allowed 6 kg</i>	
 <b>05SKITK</b>	Specific kit to mounting the KS900A Smart Bar	
<b>KAWASAKI</b>	<b>W 800 (11 → 17)</b>	
 <b>KL4101</b>	Specific pannier holder for <b>MONOKEY</b> ® side-cases <i>not compatible with the side-cases in aluminium KVE37 K-venture</i>	
 <b>KN4101</b>	Specific engine guard <i>25 mm diameter steel tube / we recommend fitting by a qualified mechanic</i>	
 <b>02SKITK</b>	Specific kit to mounting the KS900A Smart Bar	
<b>KAWASAKI</b>	<b>Z800 (13 → 17)</b>	
 <b>KZ4109</b>	Specific rear rack for <b>MONOKEY</b> ® or <b>MONOLOCK</b> ® top-case <i>to be combined with the <b>MONOKEY</b>® KM5, KM7, KM8A, KM8B, KM9A or KM9B plate, or with the <b>MONOLOCK</b>® KM5M or KM6M plate / if combined with KM8A, KM8B, KM9A, KM9B it does not allow the assembly of the stop light kit or the remote control device on the case / maximum load allowed 6 kg</i>	
 <b>TE4109K</b>	Specific holder for soft side bags or for semi-rigid side bags [RA314] <i>it can be mounted without the specific rear rack KZ4109 using the 4109KIT</i>	













→ CODICE	DESCRIZIONE	PREZZO
<b>4109KITK</b>	Specific kit to install the TE4109K without the specific rear rack KZ109	
 <b>BF04K</b>	Specific flange for fitting the tank bags with TANKLOCK system	
 <b>KA4109</b>	Specific screen, smoked 28 x 38 cm (H x W) <i>complete with fitting kit</i>	
 <b>02SKITK</b>	Specific kit to mounting the KS900A Smart Bar	
<b>KAWASAKI VN 900 CLASSIC / CUSTOM / VULCAN 900 / CLASSIC / CUSTOM (06 → 18)</b>		
 <b>KL4102</b>	Specific pannier holder for <b>MONOKEY®</b> , RETRO FIT side-cases	
 <b>A37NK</b>	Specific screen, transparent 54 x 47,2 cm (H x W) <i>to be combined with the specific AS128A2K fitting kit / high and shaded bottom version / only for Classic version</i>	
<b>AS128A2K</b>	Specific chromed rack for screen A36 and A37NK <i>only for Classic version</i>	
<b>23A</b>	Specific screen, transparent 38,8 x 41 cm (H x W) <i>to be combined with the specific AS100A2K fitting kit / low, transparent version / only for Custom version</i>	
<b>A35NK</b>	specific screen, transparent 54,9 x 46,8 cm (H x W) <i>to be combined with the specific AS100A2K fitting kit / high and shaded bottom version / only for Custom version</i>	
<b>AS100A2K</b>	Specific chromed rack for screen 23A and A35NK <i>only for Custom version</i>	
<b>KAWASAKI Z 900 (17 → 18)</b>		
 <b>KZ4118</b>	Specific rear rack for <b>MONOKEY®</b> or <b>MONOLOCK®</b> top-case <i>to be combined with the MONOKEY® KM5, KM7, KM8A, KM8B, KM9A or KM9B plate, or with the MONOLOCK® KM5M or KM6M plate / if combined with KM8A, KM8B, KM9A, KM9B it does not allow the assembly of the stop light kit or the remote control device on the case / maximum load allowed 6 kg</i>	
 <b>TST4118K</b>	Specific holder for soft side bags <i>it can be mounted without the specific rear rack KZ4118 using the 4118KITK</i>	
 <b>4118KITK</b>	Specific kit to install the TST4118K without the specific rear rack KZ4118	
 <b>BF29K</b>	Specific flange for fitting the tank bags with TANKLOCK system	
 <b>KA4118</b>	Specific screen, smoked 37 x 32 cm (H x W) <i>complete with specific fitting kit</i>	
<b>KA4118GR</b>	Specific "LIME" screen 37 x 32 cm (H x W) <i>complete with specific fitting kit / when illuminated by vehicle headlights in low light conditions, the edge glows green in colour</i>	
 <b>KPR4118</b>	Stainless steel specific radiator guard black painted	
 <b>KHP4103</b>	Specific hands protector in ABS	
<b>KAWASAKI Z 900 RS (18) <span style="color: orange;">NEW</span></b>		
 <b>KR4124</b>	Specific rear rack for <b>MONOLOCK®</b> or <b>MONOKEY®</b> top-case <i>to be combined with the K636 MONOKEY® plate (sold separately), or with the plate already included in the MONOLOCK® top-cases</i>	
 <b>KL4124</b>	Specific pannier holder for <b>MONOKEY®</b> side-cases <i>you can only mount cases MONOKEY® K22 / it can be mounted only with the specific rear rack KR4124</i>	
 <b>TMT4124K</b>	Specific holder for soft side bags or for a pair of CR601U side bags	
 <b>BF04K</b>	Specific flange for fitting the tank bags with TANKLOCK system	
 <b>KA200</b>	Universal screen, smoked 29,5 x 34 cm <i>to be combined with the specific A4124AK fitting kit</i>	
<b>A4124AK</b>	Specific fitting kit for KA200	
<b>KA801</b>	Specific smoked screen with ABS fairing <i>to be combined with the specific AC4124AK fitting kit</i>	
<b>AC4124AK</b>	Specific fitting kit KA801	
 <b>KPR4124</b>	Stainless steel specific radiator guard black painted	
 <b>05SKITK</b>	Specific kit to mounting the KS900A Smart Bar <i>also for version Z 900 RS CAFE</i>	













CODICE	DESCRIZIONE	PRICE
<b>KAWASAKI KLV 1000 (04 → 09)</b>		
 <b>K528</b>	Specific rear rack for <b>MONOKEY</b> ® top-case <b>MONOKEY</b> ® plate included	
<b>K528M</b>	Specific rear rack for <b>MONOLOCK</b> ® top-case <i>to be combined with the plate already included in the <b>MONOLOCK</b>® top-case</i>	
 <b>KL528</b>	Specific pannier holder for <b>MONOKEY</b> ®, RETRO FIT side-cases	
<b>KLX528</b>	Specific pannier holder for K33 <b>MONOKEY</b> ® <b>SIDE</b> cases	
 <b>KD260ST</b>	Specific screen, transparent 57 x 48 cm (H x W) <i>18 cm higher than original / only with spoiler / to be mounted instead of the original screen</i>	
<b>KAF260</b>	Specific Airstream sliding wind-screen, transparent Maximum height 65 cm (12 cm of extension) width 44 cm <i>to be mounted instead of the original screen</i>	
 <b>KN46</b>	Specific engine guard <i>25 mm diameter steel tube / we recommend fitting by a qualified mechanic</i>	
<b>KAWASAKI VERSYS 1000 (12 → 14)</b>		
 <b>KR4105</b>	Specific rear rack for <b>MONOKEY</b> ® top-case <b>MONOKEY</b> ® plate included	
<b>KR4105M</b>	Specific rear rack for <b>MONOLOCK</b> ® top-case <i>to be combined with the plate already included in the <b>MONOLOCK</b>® top-case</i>	
 <b>KLXR4105</b>	Specific rapid release side-case holder for K33 <b>MONOKEY</b> ® <b>SIDE</b> cases	
 <b>BF04K</b>	Specific flange for fitting the tank bags with TANKLOCK system	
 <b>KD4105ST</b>	Specific screen, transparent 49 x 48 cm (H x W) <i>to be mounted instead of the original screen / 16 cm higher than the original</i>	
<b>KAF4105</b>	Specific Airstream sliding wind-screen transparent. Maximum height 52 cm (12 cm of extension), width 48 cm <i>complete with specific fitting kit / to be mounted instead of the original screen</i>	
 <b>KN4105</b>	Specific engine guard, chromed <i>25 mm diameter steel tube / we recommend fitting by a qualified mechanic</i>	
 <b>ES4105K</b>	Specific support in aluminium and stainless steel to widen the surface support area of the original side stand	
<b>02SKITK</b>	Specific kit to mounting the KS900A Smart Bar	
<b>KAWASAKI VERSYS 1000 (15 → 16)</b>		
 <b>KR4105</b>	Specific rear rack for <b>MONOKEY</b> ® top-case <b>MONOKEY</b> ® plate included	
<b>KR4105M</b>	Specific rear rack for <b>MONOLOCK</b> ® top-case <i>to be combined with the plate already included in the <b>MONOLOCK</b>® top-case</i>	
 <b>KLR4113</b>	Specific rapid release side-case holder for <b>MONOKEY</b> ®, RETRO FIT cases	
<b>KLXR4113</b>	Specific rapid release side-case holder for K33 <b>MONOKEY</b> ® <b>SIDE</b> cases	
 <b>BF04K</b>	Specific flange for fitting the tank bags with TANKLOCK system	
 <b>KD4113ST</b>	Specific screen, transparent, 53 x 45 cm (H x W) <i>to be mounted instead of the original screen</i>	
<b>KD4105ST</b>	Specific screen, transparent 49 x 48 cm (H x W) <i>to be mounted instead of the original screen / 16 cm higher than the original</i>	
<b>KAF4105</b>	Specific Airstream sliding wind-screen transparent. Maximum height 52 cm (12 cm of extension), width 48 cm <i>complete with specific fitting kit / to be mounted instead of the original screen</i>	
 <b>KN4113</b>	Specific engine guard <i>25 mm diameter steel tube / we recommend fitting by a qualified mechanic / black colour</i>	
 <b>KHP4103</b>	Specific hands protector in ABS	
<b>ES4105K</b>	Specific support in aluminium and stainless steel to widen the surface support area of the original side stand	
<b>05SKITK</b>	Specific kit to mounting the KS900A Smart Bar	















→	CODICE	DESCRIZIONE	PREZZO
<b>KAWASAKI VERSYS 1000 (17 → 18)</b>			
	<b>KR4105</b>	Specific rear rack for <b>MONOKEY</b> ® top-case <b>MONOKEY</b> ® plate included	
	<b>KR4105M</b>	Specific rear rack for <b>MONOLOCK</b> ® top-case <i>to be combined with the plate already included in the <b>MONOLOCK</b>® top-case</i>	
	<b>KLR4120</b>	Specific rapid release side-case holder for <b>MONOKEY</b> ®, RETRO FIT cases	
	<b>KTL1146KIT</b>	Specific kit to install the KS250 Tool Box on KLR4120 <i>to be combined with KS250 and KLR4120 / it can be mounted on either the right-hand side or left-hand side of the motorcycle</i>	
	<b>BF04K</b>	Specific flange for fitting the tank bags with TANKLOCK system	
	<b>KD4120ST</b>	Specific screen, transparent 53 x 48 cm (H x W) <i>to be mounted instead of the original screen / 20 cm higher than the original</i>	
	<b>KN4113</b>	Specific engine guard <i>25 mm diameter steel tube / we recommend fitting by a qualified mechanic / black colour</i>	
	<b>KPR4120</b>	Stainless steel specific radiator guard black painted	
<b>VARIOUS ACCESSORIES</b>	<b>KHP4103</b>	Specific hands protector in ABS	
	<b>ES4120K</b>	Specific support in aluminium and stainless steel to widen the surface support area of the original side stand	
	<b>KFB4120</b>	Fairing upper bracket to be mounted behind the windshield to install KS920M, KS920L and GPS-Smartphone holder <i>For KS920M, KS920L, KS952B, KS953B, KS954B, KS955B, KS956B, KS957B</i>	
	<b>05SKITK</b>	Specific kit to mounting the KS900A Smart Bar	
<b>KAWASAKI Z 1000 (07 → 09)</b>			
	<b>KZ448</b>	Specific rear rack for <b>MONOKEY</b> ® or <b>MONOLOCK</b> ® top-case <i>to be combined with the <b>MONOKEY</b>® KM5, KM7, KM8A, KM8B, KM9A or KM9B plate, or with the <b>MONOLOCK</b>® KM5M or KM6M plate / if combined with KM8A, KM8B, KM9A, KM9B it does not allow the assembly of the stop light kit or the remote control device on the case / maximum load allowed 6 kg / in order to install it you must reposition the indicators from their original position</i>	
	<b>TE265K</b>	Specific holder for soft side bags or for semi-rigid side bags (RA314) <i>it can be mounted without the specific rear rack KZ448 using the T265KIT / you must move the indicators from their original position</i>	
<b>KAWASAKI Z 1000 (10 → 13)</b>			
	<b>BF04K</b>	Specific flange for fitting the tank bags with TANKLOCK system	
<b>KAWASAKI Z 1000 (14 → 18)</b>			
	<b>BF32K</b>	Specific flange for fitting the tank bags with TANKLOCK system	
<b>KAWASAKI Z 1000 SX (11 → 16)</b>			
	<b>KZ4100</b>	Specific rear rack for <b>MONOKEY</b> ® or <b>MONOLOCK</b> ® top-case <i>to be combined with the <b>MONOKEY</b>® KM5, KM7, KM8A, KM8B, KM9A or KM9B plate, or with the <b>MONOLOCK</b>® KM5M or KM6M plate / if combined with KM8A, KM8B, KM9A, KM9B it does not allow the assembly of the stop light kit or the remote control device on the case / it is not compatible with the original sidecase holder</i>	
	<b>KLXR4100</b>	Specific rapid release side-case holder for K33 <b>MONOKEY</b> ® <b>SIDE</b> cases <i>it can be mounted without the specific rear rack KZ4100 using the 4100KITK</i>	
	<b>4100KITK</b>	Specific kit to install the KLXR4100 without the specific rear rack KZ4100	
	<b>BF04K</b>	Specific flange for fitting the tank bags with TANKLOCK system <i>only for years from 2011 to 2013</i>	
	<b>4100DK</b>	Specific screen, smoked 56 x 37 cm (H x W) <i>to be combined with the specific D4100KITK fitting kit / 14 cm higher than the original</i>	
	<b>D4100KITK</b>	Specific fitting kit for 4100DK	
<b>KAWASAKI Z 1000 SX (17 → 18)</b>			
	<b>KZ4100</b>	Specific rear rack for <b>MONOKEY</b> ® or <b>MONOLOCK</b> ® top-case <i>to be combined with the <b>MONOKEY</b>® KM5, KM7, KM8A, KM8B, KM9A or KM9B plate, or with the <b>MONOLOCK</b>® KM5M or KM6M plate / if combined with KM8A, KM8B, KM9A, KM9B it does not allow the assembly of the stop light kit or the remote control device on the case / it is not compatible with the original sidecase holder</i>	























CODICE	DESCRIZIONE	PRICE
 <b>KLXR4100</b>	Specific rapid release side-case holder for K33 <b>MONOKEY® SIDE</b> cases <i>it can be mounted without the specific rear rack KZ4100 using the 4100KITK</i>	
<b>4100KITK</b>	Specific kit to install the KLXR4100 without the specific rear rack KZ4100	
 <b>BF04K</b>	Specific flange for fitting the tank bags with TANKLOCK system	
<b>KAWASAKI</b>	<b>NINJA H2 SX (18) <span style="background-color: orange; color: white; padding: 2px;">NEW</span></b>	
 <b>KZ4123</b>	Specific rear rack for <b>MONOKEY®</b> or <b>MONOLOCK®</b> top-case <i>to be combined with the <b>MONOKEY®</b> KM5, KM7 plate, or with the <b>MONOLOCK®</b> KM5M or KM6M plate / maximum load allowed 6 kg / it is not compatible with the original sidecase holder</i>	
 <b>KLXR4123</b>	Specific rapid release side-case holder for K33 <b>MONOKEY® SIDE</b> cases <i>it can be mounted without the specific rear rack KZ4123 using the 4123KITK</i>	
<b>4123KITK</b>	Specific kit to install the KLXR4123 without the specific rear rack KZ4123	
 <b>BF35K</b>	Specific flange for fitting the tank bags with TANKLOCK system	
<b>KAWASAKI</b>	<b>ZRX 1100 / ZRX 1100 S (97 → 01)</b>	
 <b>K4330</b>	Specific rear rack for <b>MONOKEY®</b> or <b>MONOLOCK®</b> top-case <i>To be combined with the plate <b>MONOKEY®</b> K553N, or with the plate <b>MONOLOCK®</b> MKN / maximum load allowed 6 kg</i>	
 <b>KD174S</b>	Specific screen, smoked 36,2 x 32,1 cm (H x W) <i>Made only for faired version / to be mounted instead of the original screen</i>	
<b>KAWASAKI</b>	<b>ZZR 1100 (93 → 01)</b>	
 <b>K4220</b>	Specific rear rack for <b>MONOKEY®</b> or <b>MONOLOCK®</b> top-case <i>To be combined with the plate <b>MONOKEY®</b> K553N, or with the plate <b>MONOLOCK®</b> MKN</i>	
<b>KAWASAKI</b>	<b>ZRX 1200 (02)</b>	
 <b>K4330</b>	Specific rear rack for <b>MONOKEY®</b> or <b>MONOLOCK®</b> top-case <i>To be combined with the plate <b>MONOKEY®</b> K553N, or with the plate <b>MONOLOCK®</b> MKN / maximum load allowed 6 kg</i>	
<b>KAWASAKI</b>	<b>ZRX 1200 R (02)</b>	
 <b>K4330</b>	Specific rear rack for <b>MONOKEY®</b> or <b>MONOLOCK®</b> top-case <i>To be combined with the plate <b>MONOKEY®</b> K553N, or with the plate <b>MONOLOCK®</b> MKN / maximum load allowed 6 kg</i>	
 <b>KD174S</b>	Specific screen, smoked 36,2 x 32,1 cm (H x W) <i>Made only for faired version / to be mounted instead of the original screen</i>	
<b>KAWASAKI</b>	<b>ZRX 1200 S (01 → 02)</b>	
 <b>K4330</b>	Specific rear rack for <b>MONOKEY®</b> or <b>MONOLOCK®</b> top-case <i>To be combined with the plate <b>MONOKEY®</b> K553N, or with the plate <b>MONOLOCK®</b> MKN / maximum load allowed 6 kg</i>	
<b>KAWASAKI</b>	<b>ZZR 1200 (02 → 05)</b>	
 <b>KZ441</b>	Specific rear rack for <b>MONOKEY®</b> or <b>MONOLOCK®</b> top-case <i>to be combined with the <b>MONOKEY®</b> KM5, KM7, KM8A, KM8B, KM9A or KM9B plate, or with the <b>MONOLOCK®</b> KM5M or KM6M plate / if combined with KM8A, KM8B, KM9A, KM9B it does not allow the assembly of the stop light kit or the remote control device on the case / you must remove the original grab handles, these are reproduced by the rack itself</i>	
 <b>KL441</b>	Specific pannier holder for <b>MONOKEY®</b> , RETRO FIT side-cases <i>it can be mounted only with the specific rear rack KZ441</i>	
<b>KAWASAKI</b>	<b>ZX 10 R (10 → 12)</b>	
 <b>BF04K</b>	Specific flange for fitting the tank bags with TANKLOCK system	
<b>KAWASAKI</b>	<b>GTR 1400 (07 → 15)</b>	
 <b>KR410</b>	Specific rear rack for <b>MONOKEY®</b> top-case <b>MONOKEY®</b> plate included	
 <b>KD407ST</b> ↘	Specific screen, transparent 58 x 53 cm (H x W) <i>to be mounted instead of the original screen / 8,5 cm higher than the original (07 &gt; 09) / 2,5 cm higher than original (10)</i>	

CODICE	DESCRIZIONE	PREZZO
<b>KAWASAKI ZZR 1400 / ZX 14 (06 → 11)</b>		
 <b>KLX446</b>	Specific pannier holder for K33 <b>MONOKEY® SIDE</b> cases	
<b>KAWASAKI ZZR 1400 (12 → 18)</b>		
 <b>KZ4106</b>	Specific rear rack for <b>MONOKEY®</b> or <b>MONOLOCK®</b> top-case to be combined with the <b>MONOKEY®</b> KM5, KM7, KM8A, KM8B, KM9A or KM9B plate, or with the <b>MONOLOCK®</b> KM5M or KM6M plate / if combined with KM8A, KM8B, KM9A, KM9B it does not allow the assembly of the stop light kit or the remote control device on the case	
 <b>TE4106K</b>	Specific holder for soft side bags or for semi-rigid side bags (RA314)	
 <b>KD4106S</b> ↘	Specific screen, smoked colour (H x W) 42 cm x 36 cm to be mounted instead of the original screen	
<b>KEEWAY</b>		
<b>KEEWAY GOCCIA 50 (09 → 11)</b>		
 <b>107AK</b>	Specific screen, transparent 50,8 x 66 cm (H x W) only available if article A851A is already fitted	
<b>KEEWAY RY6 50 (10 → 11)</b>		
 <b>288AK</b>	Specific screen, transparent 56 x 71,5 cm (H x W) only available if article A853A is already fitted	
<b>KEEWAY RY8 50 EVO SPORT (10 → 11)</b>		
 <b>288AK</b>	Specific screen, transparent 56 x 71,5 cm (H x W) to be combined with the specific A852AK fitting kit	
<b>A852AK</b> ↘	Specific fitting kit for 288AK	
<b>KEEWAY LOGIK 125-150 (13 → 15)</b>		
 <b>308AK</b>	Specific screen, transparent with serigraphy 52 x 66,5 cm (H x W) to be combined with the specific A9100AK fitting kit	
<b>A9100AK</b>	Specific fitting kit for 308AK	
<b>KEEWAY OUTLOOK 125-150 (09)</b>		
 <b>120AK</b>	Specific screen, transparent 66 x 67 cm (H x W) only available if article A850A is already fitted	
<b>KTM</b>		
<b>KTM DUKE 125-200-390 (11 → 16)</b>		
 <b>KR7701</b>	Specific rear rack for <b>MONOLOCK®</b> top-case to be combined with the plate already included in the <b>MONOLOCK®</b> top-case	
 <b>BF12K</b>	Specific flange for fitting the tank bags with TANKLOCK system	
 <b>247AK</b> ↘	Universal screen, smoked 29 x 28,5 cm (H x W) only available if article A7701A is already fitted	
<b>247NK</b>	Specific screen, black 29 x 28,5 cm (H x W) only available if article A7701A is already fitted	
<b>VARIOUS ACCESSORIES</b> <b>03SKITK</b>	Specific kit to mounting the KS900A Smart Bar	

CODICE	DESCRIZIONE	PRICE
<b>KTM DUKE 125-390 (17 → 18)</b>		
 <b>KZ7707</b>	Specific rear rack for <b>MONOLOCK®</b> top-case <i>to be combined with the plate already included in the <b>MONOLOCK®</b> top-case</i>	
 <b>TE7707K</b>	Specific holder for soft side bags or for semi-rigid side bags (RA314)	
 <b>BF33K</b>	Specific flange for fitting the tank bags with TANKLOCK system	
<b>VARIOUS ACCESSORIES</b> <b>KHP7707</b>	Specific hands protector in ABS	
<b>05SKITK</b>	Specific kit to mounting the KS900A Smart Bar	
<b>KTM DUKE 690 (12 → 18)</b>		
 <b>KZ7702</b>	Specific rear rack for <b>MONOKEY®</b> or <b>MONOLOCK®</b> top-case <i>to be combined with the <b>MONOKEY®</b> KM5, KM7, KM8A, KM8B, KM9A or KM9B plate, or with the <b>MONOLOCK®</b> KM5M or KM6M plate / if combined with KM8A, KM8B, KM9A, KM9B it does not allow the assembly of the stop light kit or the remote control device on the case</i>	
 <b>245AK</b>	Universal screen, smoked 33,5 x 29 cm (H x W) <i>to be combined with the specific A7702AK fitting kit</i>	
<b>245NK</b>	Universal screen, black 33,5 x 29 cm (H x W) <i>to be combined with the specific A7702AK fitting kit</i>	
<b>A7702AK</b>	Specific fitting kit for 245AK and 245NK	
<b>VARIOUS ACCESSORIES</b> <b>01SKITK</b>	Specific kit to mounting the KS900A Smart Bar	
<b>KTM DUKE 790 (18) <span style="color: orange;">NEW</span></b>		
 <b>KR7708</b>	Specific rear rack for <b>MONOKEY®</b> top-case <i>to be combined with the <b>MONOKEY®</b> KM7, KM8A, KM8B, KM9A or KM9B plate / if combined with KM8A, KM8B, KM9A, KM9B it does not allow the assembly of the stop light kit or the remote control device on the case</i>	
 <b>BF37K</b>	Specific flange for fitting the tank bags with TANKLOCK system	
 <b>KA7708</b>	Specific screen, smoked 25 x 31 cm (H x W) <i>complete with specific fitting kit</i>	
<b>KA7708OR</b>	Specific "ORANGE" screen 25 x 31 cm (H x W) <i>complete with specific fitting kit / when illuminated by vehicle headlights in low light conditions, the edge glows orange in colour</i>	
 <b>KN7708</b>	Specific engine guard, black <i>25 mm diameter steel tube / we recommend fitting by a qualified mechanic</i>	
<b>VARIOUS ACCESSORIES</b> <b>05SKITK</b>	Specific kit to mounting the KS900A Smart Bar	
<b>KTM ADVENTURE 950 / 990 (03 → 14)</b>		
 <b>KR7700</b>	Specific rear rack for <b>MONOKEY®</b> top-case <i>maximum load allowed 6 kg / <b>MONOKEY®</b> plate included</i>	
 <b>KL650</b>	Specific pannier holder for <b>MONOKEY®</b> , RETRO FIT side-cases	
<b>VARIOUS ACCESSORIES</b> <b>ES7703K</b>	Specific support in aluminium and stainless steel to widen the surface support area of the original side stand <i>only for 2013</i>	
<b>01SKITK</b>	Specific kit to mounting the KS900A Smart Bar	
<b>KTM SUPERDUKE 990 (08)</b>		
 <b>BF02K</b>	Specific flange for fitting the tank bags with TANKLOCK system	
<b>VARIOUS ACCESSORIES</b> <b>01SKITK</b>	Specific kit to mounting the KS900A Smart Bar	
<b>KTM 990 SMT (09 → 16)</b>		
<b>VARIOUS ACCESSORIES</b> <b>01SKITK</b>	Specific kit to mounting the KS900A Smart Bar	

CODICE	DESCRIZIONE	PREZZO
<b>KTM 1050 ADVENTURE (15 → 16) / 1090 ADVENTURE (17 → 18)</b>		
 <b>KR7705</b>	Specific rear rack for <b>MONOLOCK®</b> or <b>MONOKEY®</b> top-case <i>to be combined with the <b>MONOKEY®</b> KM5, KM7 plate, or with the <b>MONOLOCK®</b> KM5M or KM6M plate</i>	
<b>KRA7703</b>	Specific rear rack in aluminium for <b>MONOKEY®</b> top-case <i>maximum load allowed 6kg / it does not allow the assembly of the stop light kit or the remote control device on the case</i>	
 <b>KLR7706</b>	Specific rapid release side-case holder for <b>MONOKEY®</b> , RETRO FIT cases	
 <b>BF11K</b>	Specific flange for fitting the tank bags with TANKLOCK system <i>only with tank bag with TANKLOCK system RA311R</i>	
 <b>KD7703ST</b>	Specific screen, transparent 37 x 41 cm (H x W) <i>to be mounted instead of the original screen / 17 cm higher than original</i>	
<b>KAF7703</b>	Specific Airstream sliding wind-screen transparent. Maximum height 64 cm (12 cm of excursion) width 41 cm <i>complete with specific fitting kit / to be mounted instead of the original screen</i>	
 <b>KN7703</b>	Specific engine guard <i>25 mm diameter steel tube / we recommend fitting by a qualified mechanic / black colour</i>	
<b>RP7703K</b>	Oil carter protector in Aluminium	
<b>VARIOUS ACCESSORIES</b> <b>ES7704K</b>	Specific support in aluminium and stainless steel to widen the surface support area of the original side stand	
<b>05SKITK</b>	Specific kit to mounting the KS900A Smart Bar	
<b>KTM 1190 ADVENTURE / 1190 ADVENTURE R (13 → 16)</b>		
 <b>KR7705</b>	Specific rear rack for <b>MONOLOCK®</b> or <b>MONOKEY®</b> top-case <i>to be combined with the <b>MONOKEY®</b> KM5, KM7 plate, or with the <b>MONOLOCK®</b> KM5M or KM6M plate</i>	
<b>KRA7703</b>	Specific rear rack in aluminium for <b>MONOKEY®</b> top-case <i>maximum load allowed 6kg / it does not allow the assembly of the stop light kit or the remote control device on the case</i>	
 <b>KLR7706</b>	Specific rapid release side-case holder for <b>MONOKEY®</b> , RETRO FIT cases	
 <b>BF11K</b>	Specific flange for fitting the tank bags with TANKLOCK system <i>only with tank bag with TANKLOCK system RA311R</i>	
 <b>KD7703ST</b>	Specific screen, transparent 37 x 41 cm (H x W) <i>to be mounted instead of the original screen / 17 cm higher than original</i>	
<b>KAF7703</b>	Specific Airstream sliding wind-screen transparent. Maximum height 64 cm (12 cm of excursion) width 41 cm <i>complete with specific fitting kit / to be mounted instead of the original screen</i>	
 <b>KN7703</b>	Specific engine guard <i>only for 1190 Adventure / 25 mm diameter steel tube / we recommend fitting by a qualified mechanic / black colour</i>	
<b>RP7703K</b>	Oil carter protector in Aluminium	
<b>VARIOUS ACCESSORIES</b> <b>ES7703K</b>	Specific support in aluminium and stainless steel to widen the surface support area of the original side stand <i>only for 2013</i>	
<b>ES7704K</b>	Specific support in aluminium and stainless steel to widen the surface support area of the original side stand <i>compatible from 2014</i>	
<b>01SKITK</b>	Specific kit to mounting the KS900A Smart Bar	
<b>KTM 1290 SUPERDUKE (13 → 18)</b>		
 <b>BF11K</b>	Specific flange for fitting the tank bags with TANKLOCK system	
<b>KTM 1290 SUPER ADVENTURE (15 → 16) / 1290 SUPER ADVENTURE T (17)</b>		
 <b>KR7705</b>	Specific rear rack for <b>MONOLOCK®</b> or <b>MONOKEY®</b> top-case <i>to be combined with the <b>MONOKEY®</b> KM5, KM7 plate, or with the <b>MONOLOCK®</b> KM5M or KM6M plate</i>	
<b>KRA7703</b>	Specific rear rack in aluminium for <b>MONOKEY®</b> top-case <i>maximum load allowed 6kg / it does not allow the assembly of the stop light kit or the remote control device on the case</i>	
 <b>KLR7706</b>	Specific rapid release side-case holder for <b>MONOKEY®</b> , RETRO FIT cases	
 <b>BF11K</b>	Specific flange for fitting the tank bags with TANKLOCK system <i>only with tank bag with TANKLOCK system RA311R</i>	
<b>VARIOUS ACCESSORIES</b> <b>ES7704K</b>	Specific support in aluminium and stainless steel to widen the surface support area of the original side stand	
<b>05SKITK</b>	Specific kit to mounting the KS900A Smart Bar	

CODICE	DESCRIZIONE	PRICE
<b>KTM 1290 SUPER ADVENTURE R (17 → 18)</b>		
 <b>KRA7703</b>	Specific rear rack in aluminium for <b>MONOKEY</b> ® top-case <i>maximum load allowed 6kg / it does not allow the assembly of the stop light kit or the remote control device on the case</i>	
<b>KR7705</b>	Specific rear rack for <b>MONOLOCK</b> ® or <b>MONOKEY</b> ® top-case <i>to be combined with the <b>MONOKEY</b>® KM5, KM7 plate, or with the <b>MONOLOCK</b>® KM5M or KM6M plate</i>	
 <b>KLR7706</b>	Specific rapid release side-case holder for <b>MONOKEY</b> ®, RETRO FIT cases	
 <b>BF11K</b>	Specific flange for fitting the tank bags with TANKLOCK system <i>only with tank bag with TANKLOCK system RA311R</i>	
 <b>KD7706ST</b>	Specific screen, transparent 44 x 41 cm (H x W) <i>to be mounted instead of the original screen</i>	
<b>KD7706S</b>	Specific screen, smoked 38 x 40 cm (H x W) <i>to be mounted instead of the original screen</i>	
 <b>RP7703K</b>	Oil carter protector in Aluminium	
<b>VARIOUS ACCESSORIES</b> <b>ES7704K</b>	Specific support in aluminium and stainless steel to widen the surface support area of the original side stand	
<b>KFB7706</b>	Fairing upper bracket to be mounted behind the windshield to install KS920M, KS920L and GPS-Smartphone holder <i>For KS920M, KS920L, KS952B, KS953B, KS954B, KS955B, KS956B, KS957B</i>	
<b>05SKITK</b>	Specific kit to mounting the KS900A Smart Bar	
<b>KTM 1290 SUPER ADVENTURE S (17 → 18) <span style="background-color: orange; color: white; padding: 2px;">NEW</span></b>		
 <b>KRA7703</b>	Specific rear rack in aluminium for <b>MONOKEY</b> ® top-case <i>maximum load allowed 6kg / it does not allow the assembly of the stop light kit or the remote control device on the case</i>	
<b>KR7705</b>	Specific rear rack for <b>MONOLOCK</b> ® or <b>MONOKEY</b> ® top-case <i>to be combined with the <b>MONOKEY</b>® KM5, KM7 plate, or with the <b>MONOLOCK</b>® KM5M or KM6M plate</i>	
 <b>KLR7706</b>	Specific rapid release side-case holder for <b>MONOKEY</b> ®, RETRO FIT cases	
 <b>BF11K</b>	Specific flange for fitting the tank bags with TANKLOCK system <i>only with tank bag with TANKLOCK system RA311R</i>	
 <b>KD7706ST</b>	Specific screen, transparent 44 x 41 cm (H x W) <i>to be mounted instead of the original screen</i>	
<b>KD7706S</b>	Specific screen, smoked 38 x 40 cm (H x W) <i>to be mounted instead of the original screen</i>	
 <b>RP7703K</b>	Oil carter protector in Aluminium	
<b>VARIOUS ACCESSORIES</b> <b>ES7704K</b>	Specific support in aluminium and stainless steel to widen the surface support area of the original side stand	
<b>KFB7706</b>	Fairing upper bracket to be mounted behind the windshield to install KS920M, KS920L and GPS-Smartphone holder <i>For KS920M, KS920L, KS952B, KS953B, KS954B, KS955B, KS956B, KS957B</i>	
<b>05SKITK</b>	Specific kit to mounting the KS900A Smart Bar	
<b>KYMCO</b>		
<b>KYMCO AGILITY 50-125-150-200 R16 (08 → 13)</b>		
 <b>KE1370</b>	Specific rear rack for <b>MONOLOCK</b> ® top-case <i>to be combined with the plate already included in the <b>MONOLOCK</b>® top-case</i>	
 <b>440AK</b>	Specific screen, transparent 66 x 64 cm (H x W) <i>to be combined with the specific A440AK fitting kit</i>	
<b>441AK</b>	Specific screen, transparent 72 x 66 cm (H x W) <i>to be combined with the specific A440AK fitting kit / 6 cm higher than 440AK</i>	
<b>A440AK</b>	Specific fitting kit for 440AK and 441AK	
<b>105AK</b>	Specific screen, transparent 66 x 67 cm (H x W) <i>only available if article A439A is already fitted to be mounted instead of the original screen / to be combined with the specific A439A fitting kit</i>	
<b>128AK</b>	Specific screen, transparent 74 x 67 cm (H x W) <i>/ only available if article A439A is already fitted to be combined with the specific A439A fitting kit / 8 cm higher than 105AK</i>	

CODICE	DESCRIZIONE	PREZZO
<b>KYMC0 AGILITY 50-125-150-200 R16+ (14 → 18)</b>		
 <b>KR6106</b>	Specific rear rack for <b>MONOLOCK®</b> top-case <i>to be combined with the plate already included in the <b>MONOLOCK®</b> top-case</i>	
 <b>440AK</b>	Specific screen, transparent 66 x 64 cm (H x W) <i>to be combined with the specific A6106AK fitting kit</i>	
<b>441AK</b>	Specific screen, transparent 72 x 66 cm (H x W) <i>to be combined with the specific A6106AK fitting kit / 6 cm higher than 440AK</i>	
<b>A6106AK</b>	Specific fitting kit for 440AK and 441AK	
<b>KYMC0 DINK 50-125-200 I (06 → 16)</b>		
 <b>KR90</b>	Specific rear rack for <b>MONOLOCK®</b> top-case <i>to be combined with the plate already included in the <b>MONOLOCK®</b> top-case</i>	
 <b>292DTK</b>	Specific screen, transparent 67 x 58 cm (H x W) <i>to be combined with the specific D292KITK fitting kit / 37 cm higher than the original</i>	
<b>D292KITK</b>	Specific fitting kit for 292DTK	
<b>KYMC0 LIKE 125-150 (17 → 18)</b>		
 <b>KR6109</b>	Specific rear rack for <b>MONOLOCK®</b> top-case <i>to be combined with the plate already included in the <b>MONOLOCK®</b> top-case</i>	
 <b>6109AK</b>	Specific screen, transparent 49,5 x 65,5 cm (H x W) <i>to be combined with the specific A6109AK fitting kit</i>	
<b>A6109AK</b>	Specific fitting kit for 6109AK	
<b>KYMC0 LIKE 50-125-200I (09 → 16)</b>		
 <b>6102AK</b>	Specific screen, transparent 52 x 66,6 cm (H x W) <i>to be combined with the specific A6102AK fitting kit</i>	
<b>A6102AK</b>	Specific fitting kit for 6102AK	
<b>KYMC0 PEOPLE S 50-125-200 (05 → 15)</b>		
 <b>137AK</b>	Specific screen, transparent 64 x 71 cm (H x W) <i>to be combined with the specific A137AK fitting kit</i>	
<b>A137AK</b>	Specific fitting kit for 137AK	
<b>You can fit a MONOLOCK® top-case using the universal plate included</b>		
<b>KYMC0 DOWNTOWN 125I-200I-300I (09 → 17)</b>		
 <b>KR92</b>	Specific rear rack for <b>MONOKEY®</b> top-case <b>MONOKEY®</b> plate included / maximum load allowed 6 kg	
<b>KR920</b>	Specific rear rack for <b>MONOLOCK®</b> top-case <i>to be combined with the plate already included in the <b>MONOLOCK®</b> top-case</i>	
 <b>KD294ST</b>	Specific screen, transparent 81.5 x 64 cm (H x W) <i>to be mounted instead of the original screen / 15,5 cm higher than the original</i>	
<b>VARIOUS ACCESSORIES</b> <b>KTB82</b>	Specific backrest <i>It cannot be mounted if rack and case are installed</i>	
<b>KYMC0 GRAND DINK 125-150-250 (00 → 07)</b>		
 <b>290DTK</b>	Specific screen, transparent 60,6 x 70 cm (H x W) <i>to be combined with the specific D290KITK fitting kit</i>	
<b>D290KITK</b> ↘	Specific fitting kit for 290DTK	
<b>KYMC0 G-DINK 125-300 (12 → 17)</b>		
 <b>KR6101</b>	Specific rear rack for <b>MONOLOCK®</b> top-case <i>to be combined with the plate already included in the <b>MONOLOCK®</b> top-case</i>	
 <b>KD6101ST</b>	Specific screen, transparent 75,5 x 57 cm (H x W) <i>to be mounted instead of the original screen / 24,5 cm higher than the original</i>	

CODICE	DESCRIZIONE	PRICE
<b>KYMCO K-XCT 125I-300I (13 → 17)</b>		
 <b>KR6103</b>	Specific rear rack for <b>MONOKEY</b> ® top-case <i>maximum load allowed 6 kg / <b>MONOKEY</b>® plate included</i>	
<b>KR6103M</b>	Specific rear rack for <b>MONOLOCK</b> ® top-case <b>MONOLOCK</b> ® plate included	
 <b>KAF6103</b>	Specific Airstream sliding wind-screen transparent. Maximum height 81,5 cm (12 cm of excursion), width 57 cm <i>to be mounted instead of the original screen</i>	
<b>KD6103ST</b>	Specific screen, transparent 83 x 57 cm (H x W) <i>to be mounted instead of the original screen</i>	
<b>KYMCO PEOPLE GTI 125-200-300 (10 → 18)</b>		
 <b>KE1390</b>	Specific rear rack for <b>MONOLOCK</b> ® top-case <i>to be combined with the plate already included in the <b>MONOLOCK</b>® top-case</i>	
 <b>443AK</b>	Specific screen, transparent 53 x 72 cm (H x W) <i>to be combined with the specific A443AK fitting kit</i>	
<b>A443AK</b>	Specific fitting kit for 443AK	
<b>KYMCO XTOWN 125-300 (16 → 18)</b>		
 <b>KR6108</b>	Specific rear black rack for <b>MONOLOCK</b> ® or <b>MONOKEY</b> ® top-case <i>to be combined with the <b>MONOKEY</b>® KM5, KM7 plate, or with the <b>MONOLOCK</b>® KM5M or KM6M plate, or with the plate already included in the <b>MONOLOCK</b>® top-cases</i>	
 <b>KD294ST</b>	Specific screen, transparent 81.5 x 64 cm (H x W) <i>to be mounted instead of the original screen / 15,5 cm higher than the original</i>	
 <b>KTB6108</b>	Specific backrest <i>it cannot be mounted if rack and case are installed</i>	
<b>VARIOUS ACCESSORIES</b>		
<b>KYMCO XCITING 250-300-500 (05 → 09)</b>		
 <b>KR89M</b>	Specific rear rack for <b>MONOLOCK</b> ® top-case <i>to be combined with the plate already included in the <b>MONOLOCK</b>® top-case</i>	
 <b>KD293ST</b>	Specific screen, transparent 87 x 64 cm (H x W) <i>to be mounted instead of the original screen / with hand protectors</i>	
<b>KYMCO XCITING 300I-500I R (09 → 14)</b>		
 <b>KR910</b>	Specific rear rack for <b>MONOLOCK</b> ® top-case <i>to be combined with the plate already included in the <b>MONOLOCK</b>® top-case</i>	
 <b>KD295ST</b>	Specific screen, transparent 85.5 x 66 cm (H x W) <i>to be mounted instead of the original screen / 25 cm higher than original</i>	
<b>KYMCO G-DINK 300 (18) <span style="background-color: orange; color: white; padding: 2px;">NEW</span></b>		
 <b>KR6111</b>	Specific rear rack for <b>MONOLOCK</b> ® top-case <i>to be combined with the plate already included in the <b>MONOLOCK</b>® top-case</i>	
 <b>6111DTK</b>	Specific screen, transparent 86 x 71 cm (H x W) <i>to be combined with the specific D6111KITK fitting kit</i>	
<b>D6111KITK</b>	Specific fitting kit for 6111DTK	
<b>KYMCO DOWNTOWN ABS 125I / 350I (15 → 18)</b>		
 <b>KR6107</b>	Specific rear rack for <b>MONOLOCK</b> ® or <b>MONOKEY</b> ® top-case <i>to be combined with the <b>MONOKEY</b>® KM5, KM7 plate, or with the <b>MONOLOCK</b>® KM6M plate, or with the plate already included in the <b>MONOLOCK</b>® top-case</i>	
 <b>KD6107ST</b>	Specific screen, transparent 92,5 x 63,5 cm (H x W) <i>to be mounted instead of the original screen / 31,5 cm higher than the original</i>	
 <b>KTB6107</b>	Specific backrest <i>it cannot be mounted if rack and case are installed</i>	
<b>VARIOUS ACCESSORIES</b>		
<b>KYMCO XCITING 400I (13 → 17)</b>		
 <b>KR6104</b>	Specific rear rack for <b>MONOKEY</b> ® top-case <i>maximum load allowed 6 kg / <b>MONOKEY</b>® plate included</i>	
<b>KR6104M</b>	Specific rear rack for <b>MONOLOCK</b> ® top-case <b>MONOLOCK</b> ® plate included	
 <b>KD6104ST</b>	Specific wind-screen, colour transparent. 85 x 63 cm (H x W) <i>to be mounted instead of the original screen / 28 cm higher than the original</i>	
 <b>KTB6104</b>	Specific backrest <i>it cannot be mounted if rack and case are installed</i>	
<b>VARIOUS ACCESSORIES</b>		

CODICE	DESCRIZIONE	PREZZO
--------	-------------	--------

## KYMCO XCITING S400I (18)



**KR6112**

Specific rear rack for **MONOLOCK**® or **MONOKEY**® top-case to be combined with the **MONOKEY**® KM5, KM8A, KM8B, KM9A or KM9B plate, or with the **MONOLOCK**® KM5M or KM6M plate or with the plate already included in the **MONOLOCK**® top-cases / if combined with KM8A, KM8B, KM9A, KM9B it does not allow the assembly of the stop light kit or the remote control device on the case / maximum load allowed 6 kg



**KD6104ST**

Specific screen, transparent, 85 x 63 cm (H x W) to be combined with the specific D6112KITK fitting kit / to be mounted instead of the original screen / 28 cm higher than the original

**D6112KITK**

Specific fitting kit for KD6104ST

## KYMCO AK 550 (17 → 18)



**KR6110**

Specific rear rack for **MONOLOCK**® or **MONOKEY**® top-case to be combined with the **MONOKEY**® KM5, KM7, KM8A, KM8B, KM9A or KM9B plate, or with the **MONOLOCK**® KM5M or KM6M plate / if combined with KM8A, KM8B, KM9A, KM9B it does not allow the assembly of the stop light kit or the remote control device on the case



**KD6110ST**

Specific screen, transparent 70 x 66 cm (H x W) to be mounted instead of the original screen

**KD6110S**

Specific low sports screen smoked 42 x 48,5 cm (H x W) to be mounted instead of the original screen

## LML

### LML STAR 125-150 (09 → 18)



**642AK**

Specific screen, transparent 54 x 62 cm (H x W) to be combined with the specific A642AK fitting kit

## MASH

### MASH SEVENTY FIVE 125 (14 → 18)



**KR9200**

Specific rear black rack for **MONOLOCK**® top-case to be combined with the plate already included in the **MONOLOCK**® top-case



**KL9200**

Specific pannier holder for **MONOKEY**® side-cases you can only mount cases **MONOKEY**® K22

**VARIOUS ACCESSORIES**

**02SKITK**

Specific kit to mounting the KS900A Smart Bar

## MBK

### MBK BOOSTER 50 (05 → 17)



**KR3560**

Specific rear rack for **MONOLOCK**® top-case it is necessary to remove the original grab handle / to be combined with the plate already included in the **MONOLOCK**® top-case



**KR366**

Specific rear rack for **MONOLOCK**® top-case to be combined with the plate already included in the **MONOLOCK**® top-case



**105AK**

Specific screen, transparent 66 x 67 cm (H x W) to be combined with the specific A285AK fitting kit / With hand protectors













**128AK**













Specific screen, transparent 74 x 67 cm (H x W) to be combined with the specific A285AK fitting kit/ 8 cm higher than 105AK





**A285AK**

Specific fitting kit for 105AK and 128AK



















CODICE	DESCRIZIONE	PRICE
<b>MBK</b>	<b>OVETTO 50-100 (97 → 02)</b>	
 <b>KR86</b>	Specific rear rack for <b>MONOLOCK®</b> top-case <i>to be combined with the plate already included in the <b>MONOLOCK®</b> top-case</i>	
<b>MBK</b>	<b>FLIPPER 114 (13 → 17)</b>	
 <b>KR2114</b>	Specific rear rack for <b>MONOLOCK®</b> top-case <i>to be combined with the plate already included in the <b>MONOLOCK®</b> top-case</i>	
 <b>2114AK</b>	Specific screen, transparent, 40 x 72 cm (H x W) <i>to be combined with the specific A2114AK fitting kit</i>	
<b>A2114AK</b>	Specific fitting kit for 2114AK	
<b>MBK</b>	<b>TRYPTIK 125 (14 → 17)</b>	
 <b>2120DTK</b>	Specific screen, transparent, 74 x 63 cm (H x W) <i>to be mounted instead of the original screen / to be combined with the specific D2120KITK fitting kit</i>	
<b>D2120KITK</b>	Specific fitting kit for 2120DTK	
 <b>KR2120</b>	Specific rear rack for <b>MONOLOCK®</b> top-case <i>to be combined with the plate already included in the <b>MONOLOCK®</b> top-case or KM6M</i>	
<b>VARIOUS ACCESSORIES</b> <b>KTB2120</b>	Specific backrest <i>it cannot be mounted if rack and case are installed</i>	
<b>MBK</b>	<b>CITYLINER 125 (07 → 12)</b>	
 <b>KD439ST</b>	Specific screen, transparent with serigraphy 71 x 77 cm (H x W) <i>to be mounted instead of the original screen / 22 cm higher than the original</i>	
<b>MBK</b>	<b>FLAME X 125 (07 → 12)</b>	
 <b>KR354</b>	Specific rear rack for <b>MONOLOCK®</b> top-case <i>to be combined with the plate already included in the <b>MONOLOCK®</b> top-case</i>	
 <b>128AK</b>	Specific screen, transparent 74 x 67 cm (H x W) <i>to be combined with the specific A283AK fitting kit / 8 cm higher than 102AK</i>	
<b>102AK</b>	Specific screen, transparent 66 x 68 cm (H x W) <i>to be combined with the specific A283AK fitting kit</i>	
<b>A283AK</b>	Specific fitting kit for 102AK and 128AK	
<b>MBK</b>	<b>SKYCRUISER 125 (05 → 09)</b>	
 <b>KR355</b>	Specific rear rack for <b>MONOKEY®</b> top-case <i>you must puncture the housing behind the saddle in arranged sections / <b>MONOKEY®</b> plate included</i>	
<b>KR3550</b>	Specific rear rack for <b>MONOLOCK®</b> top-case <i>you must puncture the housing behind the saddle in arranged sections / to be combined with the plate already included in the <b>MONOLOCK®</b> top-case</i>	
 <b>KD438ST</b>	Specific screen, transparent 63,5 x 69,5 cm (H x W) <i>to be mounted instead of the original screen / 25,5 cm higher than original</i>	
<b>VARIOUS ACCESSORIES</b> <b>KTB49</b>	Specific backrest <i>It cannot be mounted if rack and case are installed</i>	
<b>MBK</b>	<b>SKYCRUISER 125 (10 → 12)</b>	
 <b>KR370</b>	Specific rear rack for <b>MONOKEY®</b> top-case <i>maximum load allowed 6 kg / <b>MONOKEY®</b> plate included / it is necessary to puncture the housing behind the saddle</i>	
<b>KR3700</b>	Specific rear rack for <b>MONOLOCK®</b> top-case <i>it is necessary to puncture the housing behind the saddle / to be combined with the plate already included in the <b>MONOLOCK®</b> top-case</i>	
 <b>446DTK</b>	Specific screen, transparent 73,5 x 63 cm (H x W) <i>to be combined with the specific D446KITK fitting kit / 30 cm higher than original</i>	
<b>D446KITK</b>	Specific fitting kit for 446DTK	
<b>KD446B</b>	Specific low and sports screen gloss black 37 x 43 cm (H x W) <i>to be mounted instead of the original screen</i>	
<b>VARIOUS ACCESSORIES</b> <b>KTB55</b>	Specific backrest <i>It cannot be mounted if rack and case are installed</i>	

CODICE	DESCRIZIONE	PREZZO
<b>MBK</b>	<b>WAAP 125 (10 → 12)</b>	
 <b>288AK</b>	Specific screen, transparent 56 x 71,5 cm (H x W) <i>only available if article A289A is already fitted</i>	
<b>MBK</b>	<b>SKYLINER S 125 (14)</b>	
 <b>KR2121</b>	Specific rear rack for <b>MONOLOCK®</b> top-case <i>to be combined with the plate already included in the MONOLOCK® top-case or with the MONOLOCK® KM5M or KM6M plate</i>	
 <b>2121DTK</b>	Specific screen, transparent 70,5 x 50 cm (H x W) <i>to be combined with the specific D2121KITK fitting kit</i>	
<b>D2121KITK</b>	Specific fitting kit for 2121DTK	
<b>MBK</b>	<b>SKYLINER 125-150 CAT. (01 → 13)</b>	
 <b>KR460</b>	Specific rear rack for <b>MONOLOCK®</b> top-case <i>to be combined with the plate already included in the MONOLOCK® top-case</i>	
 <b>130DTK</b>	Specific screen, transparent 69,2 x 68,2 cm (H x W) <i>to be combined with the specific D130KITK fitting kit</i>	
<b>D130KITK</b>	Specific fitting kit for 130DTK	
<b>MBK</b>	<b>OCEO 125-150 (12 → 14)</b>	
 <b>KR2102</b>	Specific rear rack for <b>MONOLOCK®</b> or <b>MONOKEY®</b> top-case <i>to be combined with the K636 MONOKEY® plate (sold separately), or with the plate already included in the MONOLOCK® top-cases / maximum load allowed 6 kg</i>	
 <b>KD2102ST</b>	Specific screen, transparent 65 x 70 cm (H x W) <i>to be mounted instead of the original screen / 14 cm higher than the original wind-screen</i>	
<b>MBK</b>	<b>EVOLYS 125-250 (14 → 17)</b>	
 <b>KR2117</b>	Specific rear rack for <b>MONOKEY®</b> top-case <i>maximum load allowed 6 kg / MONOKEY® plate included</i>	
<b>KR2117M</b>	Specific rear rack for <b>MONOLOCK®</b> top-case <i>to be combined with the plate already included in the MONOLOCK® top-case</i>	
 <b>2111DTK</b>	Specific screen, transparent 73 x 59 cm (H x W) <i>to be combined with the specific D2111KITK fitting kit</i>	
<b>D2111KITK</b>	Specific fitting kit for 2111DTK	
<b>VARIOUS ACCESSORIES</b> <b>KTB2111</b>	Specific backrest <i>it cannot be mounted if rack and case are installed</i>	
<b>MBK</b>	<b>SKYLINER 125-250 (14)</b>	
 <b>KR2117</b>	Specific rear rack for <b>MONOKEY®</b> top-case <i>maximum load allowed 6 kg / MONOKEY® plate included</i>	
<b>KR2117M</b>	Specific rear rack for <b>MONOLOCK®</b> top-case <i>to be combined with the plate already included in the MONOLOCK® top-case</i>	
 <b>2111DTK</b>	Specific screen, transparent 73 x 59 cm (H x W) <i>to be combined with the specific D2111KITK fitting kit</i>	
<b>D2111KITK</b>	Specific fitting kit for 2111DTK	
<b>VARIOUS ACCESSORIES</b> <b>KTB2111</b>	Specific backrest <i>it cannot be mounted if rack and case are installed</i>	
<b>MBK</b>	<b>SKYLINER 250 (00 → 07)</b>	
 <b>KR44</b>	Specific rear rack for <b>MONOKEY®</b> top-case <b>MONOKEY® plate included</b>	
<b>KR44M</b>	Specific rear rack for <b>MONOLOCK®</b> top-case <b>MONOLOCK® plate included</b>	
 <b>KD127ST</b>	Specific screen, transparent 80 x 70,7 cm (H x W) <i>to be mounted instead of the original screen / without moulding steel / without air intake</i>	





CODICE	DESCRIZIONE	PRICE
<b>MBK</b>	<b>KILIBRE 300 (03 → 07)</b>	
 <b>KD432ST</b>	Specific screen, transparent 72 x 75 cm (H x W) <i>to be mounted instead of the original screen / 22 cm higher than the original</i>	
<b>MBK</b>	<b>NITRO (13 → 17)</b>	
 <b>KR2113</b>	Specific rear rack for <b>MONOLOCK®</b> top-case <i>to be combined with the plate already included in the <b>MONOLOCK®</b> top-case</i>	
 <b>288AK</b>	Specific screen, transparent 56 x 71,5 cm (H x W) <i>to be combined with the specific A2113AK fitting kit</i>	
<b>A2113AK</b> ↘	Specific fitting kit, black for 288AK	
<b>MBK</b>	<b>X-OVER (10)</b>	
 <b>KR372</b>	Specific rear rack for <b>MONOLOCK®</b> top-case <i>to be combined with the plate already included in the <b>MONOLOCK®</b> top-case / you must remove the grab rails, they are replaced by the rack itself</i>	
 <b>288AK</b>	Specific screen, transparent 56 x 71,5 cm (H x W) <i>to be combined with the specific A288AK fitting kit</i>	
<b>A288AK</b>	Specific fitting kit, black for 288AK	



## MOTO GUZZI

<b>MOTO GUZZI</b>	<b>BREVA 750 (03 → 12)</b>	
 <b>K7030</b>	Specific rear rack for <b>MONOKEY®</b> or <b>MONOLOCK®</b> top-case <i>To be combined with the plate <b>MONOKEY®</b> K553N, or with the plate <b>MONOLOCK®</b> MKN/ it is compatible with the original side-case holder / black colour</i>	
<b>MOTO GUZZI</b>	<b>BREVA 850-1100-1200 (05 → 12)</b>	
 <b>KR210</b>	Specific rear rack for <b>MONOKEY®</b> top-case <i>is compatible with the original side-case holder / <b>MONOKEY®</b> plate included</i>	
<b>KR210M</b>	Specific rear rack for <b>MONOLOCK®</b> top-case <i>is compatible with the original side-case holder / <b>MONOLOCK®</b> plate included</i>	
<b>MOTO GUZZI</b>	<b>NORGE 850-1200 (06 → 16)</b>	
 <b>KR210</b>	Specific rear rack for <b>MONOKEY®</b> top-case <i>is compatible with the original side-case holder / <b>MONOKEY®</b> plate included</i>	
<b>KR210M</b>	Specific rear rack for <b>MONOLOCK®</b> top-case <i>is compatible with the original side-case holder / <b>MONOLOCK®</b> plate included</i>	
<b>MOTO GUZZI</b>	<b>STELVIO 1200 (08 → 16)</b>	
 <b>K708</b>	Specific rear rack for <b>MONOKEY®</b> top-case <b>MONOKEY®</b> plate included	
 <b>KD610ST</b> ↘	Specific screen, transparent 61 x 46 cm (H x W) <i>only for (08 &gt; 10) / to be mounted instead of the original screen / 13 cm higher than the original</i>	
<b>VARIOUS ACCESSORIES</b> <b>01SKITK</b>	Specific kit to mounting the KS900A Smart Bar	
<b>MOTO GUZZI</b>	<b>V7 (12 → 16)</b>	
 <b>TE8201K</b>	Specific holder for soft side bags or for semi-rigid side bags (RA314)	
<b>MOTO GUZZI</b>	<b>V7 III STONE / SPECIAL (17 → 18)</b>	
 <b>KR8201</b>	Specific rear black rack for <b>MONOLOCK®</b> or <b>MONOKEY®</b> top-case <i>to be combined with the K636 <b>MONOKEY®</b> plate (sold separately), or with the plate already included in the <b>MONOLOCK®</b> top-cases / maximum load allowed 6 kg</i>	

CODICE	DESCRIZIONE	PREZZO
 <b>KL8201</b>	Specific pannier holder for <b>MONOKEY®</b> side-cases <i>for version V7 Special it is necessary to remove the original grab handle / you can only mount cases <b>MONOKEY®</b> K22</i>	
 <b>TMT8201K</b>	Specific holder for soft side bags <i>for version V7 Special it is necessary to remove the original grab handle / it is not compatible with CR601U side bags</i>	
 <b>100ALK</b>	Grey anodized aluminium universal screen Race Cafe, for naked motorcycles 20,5 x 26,5 cm (H x W) <i>to be combined with the specific AL8201AK fitting kit</i>	
<b>100ALBK</b>	Black anodized aluminium universal screen Race Cafe, for naked motorcycles 20,5 x 26,5 cm (H x W) <i>to be combined with the specific AL8201AK fitting kit</i>	
<b>140AK</b>	Universal transparent screen 35 x 41cm (H x W) <i>to be combined with the specific AL8201AK fitting kit</i>	
<b>140SK</b>	Universal smoked screen 35 x 41 cm (H x W) <i>to be combined with the specific AL8201AK fitting kit</i>	
<b>AL8201AK</b>	Specific fitting kit for 100ALK, 100ALBK, 140AK, 140SK	
<b>A8201AK</b>	Specific fitting kit A800NK	
 <b>KN8202</b>	Specific engine guard, black <i>25 mm diameter steel tube / we recommend fitting by a qualified mechanic</i>	
<b>MOTO GUZZI V9 ROAMER / V9 BOBBER (16 → 18)</b>		
 <b>KR8202</b>	Specific rear black rack for <b>MONOLOCK®</b> or <b>MONOKEY®</b> top-case <i>Compatibility with the V9 Bobber model is to be confirmed / only for version 2016 / to be combined with the K636 <b>MONOKEY®</b> plate (sold separately), or with the plate already included in the <b>MONOLOCK®</b> top-cases</i>	
 <b>KL8202</b>	Specific pannier holder for <b>MONOKEY®</b> , RETRO FIT side-cases	
 <b>100ALK</b>	Grey anodized aluminium universal screen Race Cafe, for naked motorcycles 20,5 x 26,5 cm (H x W) <i>to be combined with the specific AL8202AK fitting kit</i>	
<b>100ALBK</b>	Black anodized aluminium universal screen Race Cafe, for naked motorcycles 20,5 x 26,5 cm (H x W) <i>to be combined with the specific AL8202AK fitting kit</i>	
<b>140AK</b>	Universal transparent screen 35 x 41cm (H x W) <i>to be combined with the specific AL8202AK fitting kit</i>	
<b>140SK</b>	Universal smoked screen 35 x 41 cm (H x W) <i>to be combined with the specific AL8202AK fitting kit</i>	
<b>AL8202AK</b>	Specific fitting kit for 100ALK, 100ALBK, 140AK, 140SK	
 <b>KN8202</b>	Specific engine guard, black <i>25 mm diameter steel tube / we recommend fitting by a qualified mechanic</i>	
 <b>KTS8202B</b>	Backrest with detachable small luggage carrier, black <i>only for V9 Bobber</i>	
<b>03SKITK</b>	Specific kit to mounting the KS900A Smart Bar	

## MV AGUSTA

<b>MV AGUSTA</b>	<b>AGUSTA BRUTALE 675-800 (13 → 15)</b>
 <b>TST9000K</b>	Specific holder for soft side bags
 <b>BF02K</b>	Specific flange for fitting the tank bags with TANKLOCK system
<b>MV AGUSTA</b>	<b>AGUSTA BRUTALE 750-910</b>
 <b>BF05K</b>	Specific flange for fitting the tank bags with TANKLOCK system
<b>MV AGUSTA</b>	<b>TURISMO VELOCE 800 (15)</b>
 <b>BF02K</b>	Specific flange for fitting the tank bags with TANKLOCK system

CODICE	DESCRIZIONE	PRICE
<b>MV AGUSTA</b>  <b>BF02K</b>	<b>F3 675-800</b> Specific flange for fitting the tank bags with TANKLOCK system	
<b>MV AGUSTA</b>  <b>BF05K</b>	<b>F4 750-1000</b> Specific flange for fitting the tank bags with TANKLOCK system	



## PEUGEOT

PEUGEOT	TWEET 50-125-150 (10 → 18)
 <b>107AK</b>	Specific screen, transparent 50,8 x 66 cm (H x W) <i>only available if article A299A is already fitted</i>
<b>8100AK</b>	Specific screen, transparent 50,8 x 66 cm (H x W) <i>to be combined with the specific A8100AK fitting kit</i>
<b>A8100AK</b>	Specific fitting kit for 8100AK

PEUGEOT	BELVILLE 125-200 (17 → 18)
 <b>107AK</b>	Specific screen, transparent 50,8 x 66 cm (H x W) <i>to be combined with the specific A8101AK fitting kit</i>
<b>A8101AK</b>	Specific fitting kit for 107AK















a MONOLOCK® top-case can be fitted using the universal plate included











PEUGEOT	LXR 125-200 (09 → 16)
 <b>105AK</b>	Specific screen, transparent 66 x 67 cm (H x W) <i>to be combined with the specific A298AK fitting kit</i>
<b>128AK</b>	Specific screen, transparent 74 x 67 cm (H x W) <i>to be combined with the specific A298AK fitting kit / 8 cm higher than 105AK</i>
<b>A298AK</b>	Specific fitting kit for 105AK and 128AK













PEUGEOT	SV 250 (02)
 <b>KR140</b>	Specific rear rack for <b>MONOLOCK®</b> or <b>MONOKEY®</b> top-case <i>to be combined with the K636 MONOKEY® plate (sold separately), or with the plate already included in the MONOLOCK® top-cases</i>
 <b>KD199ST</b>	Specific screen, transparent 49,9 x 72,5 cm (H x W) <i>to be mounted instead of the original screen</i>
<b>KD202ST</b>	Specific screen, transparent 60 x 74,4 cm (H x W) <i>to be mounted instead of the original screen / 10 cm higher than KD199ST</i>
<b>D199KITK</b>	Kit for a better anchorage of the spoilers: KD199ST and KD202ST

## PIAGGIO

PIAGGIO	ZIP 50 2T / 50 4T (13 → 18)
 <b>6102AK</b>	Specific screen, transparent 52 x 66,6 cm (H x W) <i>only available if article A5607A is already fitted</i>









CODICE	DESCRIZIONE	PREZZO
<b>PIAGGIO</b>  <b>KR5605</b>	<b>NEW FLY 50-125 (12 → 17)</b> Specific rear rack for <b>MONOLOCK®</b> top-case <i>to be combined with the plate already included in the <b>MONOLOCK®</b> top-case / it is necessary to puncture the housing behind the saddle in arranged sections</i>	
<b>PIAGGIO</b>  <b>KR5602</b>	<b>TYPHOON 50-125 (11 → 17)</b> Specific rear rack for <b>MONOLOCK®</b> top-case <i>maximum load allowed 3 kg / to be combined with the plate already included in the <b>MONOLOCK®</b> top-case</i>	
 <b>288AK</b>	Specific screen, transparent 56 x 71,5 cm (H x W) <i>to be combined with the specific A5602AK fitting kit</i>	
<b>A5602AK</b>	Specific fitting kit, black for 288AK	
<b>PIAGGIO</b>  <b>KR5608</b>	<b>VESPA PRIMAVERA 50-125-150 (14 → 18)</b> Specific rear black rack for <b>MONOLOCK®</b> top-case <i>to be combined with the plate already included in the <b>MONOLOCK®</b> top-case</i>	
 <b>5608AK</b>	Specific screen, transparent 50 x 69 cm (H x W) <i>to be combined with the specific A5608AK fitting kit</i>	
<b>A5608AK</b>	Specific fitting kit for 5608AK	
<b>PIAGGIO</b>  <b>KR5608</b>	<b>VESPA SPRINT 50-125-150 (14 → 18)</b> Specific rear black rack for <b>MONOLOCK®</b> top-case <i>to be combined with the plate already included in the <b>MONOLOCK®</b> top-case</i>	
 <b>5610AK</b>	Specific screen, transparent 50 x 69 cm (H x W) <i>to be combined with the specific A5608AK fitting kit</i>	
<b>A5608AK</b>	Specific fitting kit for 5610AK	
<b>PIAGGIO</b>  <b>KR56</b>	<b>ZIP 50-125 (00 → 12)</b> Specific rear rack for <b>MONOLOCK®</b> or <b>MONOKEY®</b> top-case <i>to be combined with the K636 <b>MONOKEY®</b> plate (sold separately), or with the plate already included in the <b>MONOLOCK®</b> top-cases</i>	
 <b>6102AK</b>	Specific screen, transparent 52 x 66,6 cm (H x W) <i>only available if article A5607A is already fitted</i>	
<b>PIAGGIO</b>  <b>KR104</b>	<b>FLY 50-100-125-150 (04 → 17)</b> Specific rear rack for <b>MONOLOCK®</b> top-case <i>to be combined with the plate already included in the <b>MONOLOCK®</b> top-case</i>	
 <b>107AK</b>	Specific screen, transparent 50,8 x 66 cm (H x W) <i>to be combined with the specific A110AK fitting kit</i>	
<b>A110AK</b>	Specific fitting kit for 107AK	
<b>PIAGGIO</b>  <b>KR5611</b>	<b>LIBERTY 50-125-150 (09 → 15)</b> Specific rear rack for <b>MONOLOCK®</b> top-case <i>to be combined with the plate already included in the <b>MONOLOCK®</b> top-case</i>	
 <b>107AK</b>	Specific screen, transparent 50,8 x 66 cm (H x W) <i>to be combined with the specific A107AK fitting kit</i>	
<b>A107AK</b>	Specific fitting kit for 107AK	
<b>PIAGGIO</b>  <b>KR5611</b>	<b>LIBERTY 50-125-150 I-GET (16 → 18)</b> Specific rear rack for <b>MONOLOCK®</b> top-case <i>to be combined with the plate already included in the <b>MONOLOCK®</b> top-case</i>	
 <b>107AK</b>	Specific screen, transparent 50,8 x 66 cm (H x W) <i>to be combined with the specific A107AK fitting kit</i>	
<b>A107AK</b>	Specific fitting kit for 107AK	

CODICE	DESCRIZIONE	PRICE
<b>PIAGGIO VESPA LX 50-125-150 (05 → 14)</b>		
 <b>KR105</b>	Specific rear rack for <b>MONOLOCK®</b> top-case <i>to be combined with the plate already included in the <b>MONOLOCK®</b> top-case</i>	
 <b>104AK</b>	Specific screen, transparent 51,5 x 69,5 cm (H x W) <i>to be combined with the specific A104AK fitting kit</i>	
<b>A104AK</b>	Specific fitting kit for 104AK	
<b>PIAGGIO VESPA S 50-125-150 (07 → 14)</b>		
 <b>KR105</b>	Specific rear rack for <b>MONOLOCK®</b> top-case <i>to be combined with the plate already included in the <b>MONOLOCK®</b> top-case</i>	
 <b>A354AK</b>	Specific fitting kit for 354A <i>only available if article 354A is already fitted</i>	
<b>PIAGGIO LIBERTY 50-125-150-200 (02 → 08)</b>		
 <b>KR5611</b>	Specific rear rack for <b>MONOLOCK®</b> top-case <i>to be combined with the plate already included in the <b>MONOLOCK®</b> top-case</i>	
 <b>107AK</b>	Specific screen, transparent 50,8 x 66 cm (H x W) <i>to be combined with the specific A107AK fitting kit</i>	
<b>A107AK</b>	Specific fitting kit for 107AK	
<b>PIAGGIO LIBERTY S 50-125-200 (06 → 12)</b>		
 <b>KR107</b>	Specific rear rack for <b>MONOLOCK®</b> top-case <i>it is necessary to remove the original grab handle / to be combined with the plate already included in the <b>MONOLOCK®</b> top-case</i>	
<b>PIAGGIO MEDLEY 125-150 (16 → 18)</b>		
 <b>KR5612</b>	Specific rear black rack for <b>MONOLOCK®</b> top-case <i>to be combined with the plate already included in the <b>MONOLOCK®</b> top-case</i>	
 <b>5612AK</b>	Specific screen, transparent 46,5 x 67 cm (H x W) <i>to be combined with the specific A5606AK fitting kit</i>	
<b>5612SK</b>	Specific screen, smoked 22,5 x 44 cm (H x W) <i>to be combined with the specific fitting kit A5606AK</i>	
<b>A5606AK</b>	Specific fitting kit for 5612AK, 5612SK	
<b>PIAGGIO VESPA PX 125-150 (11 → 17)</b>		
 <b>KR5603</b>	Specific rear rack for <b>MONOLOCK®</b> top-case <i>to be combined with the plate already included in the <b>MONOLOCK®</b> top-case</i>	
 <b>642AK</b>	Specific screen, transparent 54 x 62 cm (H x W) <i>to be combined with the specific A5603AK fitting kit</i>	
<b>A5603AK</b>	Specific fitting kit, black for 642AK	
<b>PIAGGIO X9 125-180-250 (00 → 02)</b>		
 <b>KR57</b>	Specific rear rack for <b>MONOLOCK®</b> top-case <i>to be combined with the plate already included in the <b>MONOLOCK®</b> top-case</i>	
<b>PIAGGIO BEVERLY 125-200 (01 → 04)</b>		
 <b>KE3411</b>	Specific rear rack for <b>MONOLOCK®</b> top-case <i>to be combined with the plate already included in the <b>MONOLOCK®</b> top-case</i>	
<b>PIAGGIO VESPA 125-200 GRANTURISMO (03 → 08)</b>		
 <b>104AK</b>	Specific screen, transparent 51,5 x 69,5 cm (H x W) <i>to be combined with the specific A104AK fitting kit</i>	
<b>A104AK</b>	Specific fitting kit for 104AK	





CODICE	DESCRIZIONE	PREZZO
<b>PIAGGIO VESPA GTS 125-150-250-300 (06 → 18)</b>		
 <b>104AK</b>	Specific screen, transparent 51,5 x 69,5 cm (H x W) <i>to be combined with the specific A104AK fitting kit</i>	
<b>A104AK</b>	Specific fitting kit for 104AK	
<b>PIAGGIO X8 125-150-200-250-400 (04 → 10)</b>		
 <b>KR102</b>	Specific rear rack for <b>MONOKEY</b> ® top-case <b>MONOKEY</b> ® plate included / maximum load allowed 6 kg	
<b>KR102M</b>	Specific rear rack for <b>MONOLOCK</b> ® top-case <b>MONOLOCK</b> ® plate included	
 <b>KD500ST</b>	Specific screen, transparent 80 x 60 cm (H x W) <i>to be mounted instead of the original screen / 20 cm higher than the original</i>	
<b>PIAGGIO MP3 YOURBAN 125-300 (11 → 18)</b>		
 <b>KR5600</b>	Specific rear rack for <b>MONOKEY</b> ® top-case <i>maximum load allowed 6 kg / MONOKEY</i> ® plate included	
<b>KR5600M</b>	Specific rear rack for <b>MONOLOCK</b> ® top-case <i>to be combined with the plate already included in the MONOLOCK</i> ® top-case	
 <b>5600DTK</b>	Specific screen, transparent 67 x 74 cm (H x W) <i>to be combined with the specific KD5600KIT fitting kit / 35,5 cm higher than the original</i>	
<b>KAF5600</b>	Specific Airstream sliding wind-screen transparent. Maximum height 63 cm (12 cm of extension), width 74 cm <i>complete with specific fitting kit</i>	
<b>KD5600ST</b>	Specific screen, transparent 57 x 44,5 cm (H x W) <i>to be mounted instead of the original screen / 25,5 cm higher than original</i>	
<b>VARIOUS ACCESSORIES</b> <b>KTB5600</b>	Specific backrest <i>it cannot be mounted if rack and case are installed</i>	
<b>PIAGGIO VESPA GTS 125-150-300 SUPER (08 → 18)</b>		
 <b>KR131</b>	Specific rear rack for <b>MONOLOCK</b> ® top-case <i>to be combined with the plate already included in the MONOLOCK</i> ® top-case	
 <b>104AK</b>	Specific screen, transparent 51,5 x 69,5 cm (H x W) <i>to be combined with the specific A104AK fitting kit</i>	
<b>A104AK</b>	Specific fitting kit for 104AK	
<b>PIAGGIO BEVERLY 125-250-400 (04 → 07)</b>		
 <b>KE3411</b>	Specific rear plate for <b>MONOLOCK</b> ® top-case <i>maximum load allowed 6 kg</i> <i>only for '04 version</i>	
<b>KE3440</b>	Specific rear plate for <b>MONOLOCK</b> ® top-case <i>maximum load allowed 6 kg</i> <i>compatible from model '05</i>	
<b>PIAGGIO BEVERLY TOURER 125-250-300-400 (08 → 10)</b>		
 <b>KE3440</b>	Specific rear rack for <b>MONOLOCK</b> ® top-case <i>to be combined with the plate already included in the MONOLOCK</i> ® top-case	
 <b>103AK</b>	Specific screen, transparent 43,5 x 70 cm (H x W) <i>to be combined with the specific A103AK fitting kit</i>	
<b>A103AK</b>	Specific fitting kit for 103AK	
<b>106AK</b>	Specific screen, transparent 32 x 61,5 cm (H x W) <i>to be combined with the specific A106AK fitting kit / With hand protectors</i>	
<b>A106AK</b>	Specific fitting kit for 106AK	
<b>PIAGGIO BEVERLY 125IE-300IE (10 → 18) / BEVERLY 350 SPORT TOURING (12 → 18)</b>		
 <b>KE3490</b>	Specific rear rack for <b>MONOLOCK</b> ® top-case <i>to be combined with the plate already included in the MONOLOCK</i> ® top-case	
 <b>357AK</b>	Specific screen, transparent 32 x 46 cm (H x W) <i>to be combined with the specific A357AK fitting kit</i>	
<b>5606BLK</b>	Specific BLUE LINE screen, 29 x 45 cm (H x W) <i>to be combined with the specific A357AK fitting kit / when illuminated by vehicle headlights in low light conditions, the edge glows blue in colour</i>	













CODICE	DESCRIZIONE	PRICE
<b>5606SK</b>	Specific smoked screen, 29 x 45 cm (H x W) <i>to be combined with the specific A357AK fitting kit</i>	
<b>A357AK</b>	Specific fitting kit for 357AK, 5606BLK, 5606SK	
<b>358AK</b>	Specific screen, transparent 48,5 x 71 cm (H x W) <i>only available if article A358A is already fitted</i>	
<b>5606AK</b>	Specific screen, transparent 47 x 72 cm (H x W) <i>to be combined with the specific A5606AK fitting kit</i>	
<b>A5606AK</b>	Specific fitting kit for 5606AK	
<b>PIAGGIO MP3 125 / 250 / 300/ 400 (06 → 11)</b>		
 <b>KR134M</b>	"Folding" specific rear rack for <b>MONOLOCK</b> ® top-case <b>MONOLOCK</b> ® plate included / complete with polyurethane backrest / allows hardware to be raised in order to fully open the rear trunk	
<b>KR134</b>	"Folding" specific rear rack for <b>MONOKEY</b> ® top-case <b>MONOKEY</b> ® plate included / complete with polyurethane backrest / Allows hardware to be raised in order to fully open the rear trunk / maximum load allowed 6 kg	
 <b>KD501ST</b>	Specific screen, transparent 82 x 64 cm (H x W) <i>to be mounted instead of the original screen / 40 cm higher than original (06 &gt; 08 model), 24 cm higher than original (09 &gt; 11 model)</i>	
<b>PIAGGIO X-EVO 125-250-400 (07 → 11)</b>		
 <b>KR102</b>	Specific rear rack for <b>MONOKEY</b> ® top-case <b>MONOKEY</b> ® plate included / maximum load allowed 6 kg	
<b>KR102M</b>	Specific rear rack for <b>MONOLOCK</b> ® top-case <b>MONOLOCK</b> ® plate included	
 <b>KD500ST</b>	Specific screen, transparent 80 x 60 cm (H x W) <i>to be mounted instead of the original screen / 20 cm higher than the original</i>	
<b>PIAGGIO X10 125-350-500 (12 → 16)</b>		
 <b>KD5604ST</b>	Specific screen, transparent 85,5 x 69 cm (H x W) <i>to be mounted instead of the original screen</i>	
<b>KAF5604</b>	Specific Airstream sliding wind-screen transparent. Maximum height 77 cm (12 cm of extension), width 68 cm <i>to be mounted instead of the original screen</i>	
<b>PIAGGIO X9 200-250-500 EVOLUTION (03 → 08)</b>		
 <b>KR57</b>	Specific rear rack for <b>MONOLOCK</b> ® top-case <i>to be combined with the plate already included in the <b>MONOLOCK</b>® top-case</i>	
 <b>KD229ST</b>	Specific screen, transparent 65 x 50 cm (H x W) <i>to be mounted instead of the original screen / 16 cm higher than the original</i>	
<b>PIAGGIO BEVERLY CRUISER 250 - 500 (07 → 11)</b>		
 <b>352AK</b>	Specific screen, transparent with serigraphy 50,5 x 78,5 cm (H x W) <i>to be combined with the specific A352AK fitting kit</i>	
<b>A352AK</b>	Specific fitting kit for 352AK	
<b>PIAGGIO CARNABY CRUISER 300 (09 → 12)</b>		
 <b>KE3480</b>	Specific rear rack for <b>MONOLOCK</b> ® top-case <i>to be combined with the plate already included in the <b>MONOLOCK</b>® top-case</i>	
 <b>A352AK</b>	Specific fitting kit for 356A <i>only available if article 356A is already fitted</i>	
<b>PIAGGIO MP3 TOURING 300 - 400 (11) / MP3 BUSINESS 300 (12 → 14) / MP3 SPORT 300 (12 → 14) / MP3 BUSINESS 500 (12 → 13) / MP3 SPORT 500 (12 → 13)</b>		
 <b>KR134M</b>	"Folding" specific rear rack for <b>MONOLOCK</b> ® top-case <b>MONOLOCK</b> ® plate included / complete with polyurethane backrest / allows hardware to be raised in order to fully open the rear trunk	
<b>KR134</b>	"Folding" specific rear rack for <b>MONOKEY</b> ® top-case <b>MONOKEY</b> ® plate included / complete with polyurethane backrest / Allows hardware to be raised in order to fully open the rear trunk / maximum load allowed 6 kg	

CODICE	DESCRIZIONE	PREZZO
 <b>KAF5601</b>	Specific Airstream sliding wind-screen transparent. Maximum height 67 cm (12 cm of extension), width 65 cm <i>to be mounted instead of the original screen</i>	
<b>KD5601ST</b>	Specific screen, transparent 75 x 65 cm (H x W) <i>to be mounted instead of the original screen / 12 cm higher than the original</i>	
<b>PIAGGIO MP3 300IE-500IE SPORT / BUSINESS (08/14 → 17)</b>		
 <b>KR5609</b>	Specific rear rack for <b>MONOKEY</b> ® top-case <b>MONOKEY</b> ® plate included	
<b>KR5609M</b>	Specific rear rack for <b>MONOLOCK</b> ® top-case <i>to be combined with the plate already included in the <b>MONOLOCK</b>® top-case</i>	
 <b>KAF5601</b>	Specific Airstream sliding wind-screen transparent. Maximum height 67 cm (12 cm of extension), width 65 cm <i>to be mounted instead of the original screen</i>	
<b>KD5601ST</b>	Specific screen, transparent 75 x 65 cm (H x W) <i>to be mounted instead of the original screen / 12 cm higher than the original</i>	
<b>PIAGGIO MP3 350-500 SPORT / BUSINESS (18)</b>		
 <b>KR5613</b>	Specific rear rack for <b>MONOLOCK</b> ® or <b>MONOKEY</b> ® top-case <i>to be combined with the <b>MONOKEY</b>® KM5, KM8A, KM8B, KM9A or KM9B plate, or with the <b>MONOLOCK</b>® KM5M or KM6M plate or with the plate already included in the <b>MONOLOCK</b>® top-cases / if combined with KM8A, KM8B, KM9A, KM9B it does not allow the assembly of the stop light kit or the remote control device on the case</i>	
 <b>KD5613ST</b>	Specific screen, transparent 71,5 x 65 cm (H x W) <i>to be mounted instead of the original screen / 10 cm higher than the original</i>	
<b>PIAGGIO BEVERLY 500 (03 → 07)</b>		
 <b>KE3411</b>	Specific rear plate for <b>MONOLOCK</b> ® top-case <i>maximum load allowed 6 kg / compatible with '03 and '04</i>	
<b>KE3440</b>	Specific rear plate for <b>MONOLOCK</b> ® top-case <i>maximum load allowed 6 kg / compatible from '05</i>	
 <b>103AK</b>	Specific screen, transparent 43,5 x 70 cm (H x W) <i>to be combined with the specific A103AK fitting kit</i>	
<b>A103AK</b>	Specific fitting kit for 103AK	
<b>106AK</b>	Specific screen, transparent 32 x 61,5 cm (H x W) <i>to be combined with the specific A106AK fitting kit / With hand protectors</i>	
<b>A106AK</b>	Specific fitting kit for 106AK	
<b>PIAGGIO X9 500 (01 → 02)</b>		
 <b>KR57</b>	Specific rear rack for <b>MONOLOCK</b> ® top-case <i>to be combined with the plate already included in the <b>MONOLOCK</b>® top-case</i>	



## ROYAL ENFIELD

ROYAL ENFIELD	HIMALAYAN (18) <b>NEW</b>	
 <b>KR9050</b>	Specific rear rack for <b>MONOLOCK</b> ® or <b>MONOKEY</b> ® top-case <i>to be combined with the <b>MONOKEY</b>® KM5, KM7 plate, or with the <b>MONOLOCK</b>® KM5M or KM6M plate</i>	
 <b>KL9050</b>	Specific pannier holder for <b>MONOKEY</b> ® side-cases <i>you can only mount cases <b>MONOKEY</b>® K22</i>	
<b>KTL1146KIT</b>	Specific kit to install the KS250 Tool Box on KL9050 <i>to be combined with KS250 and KL9050 / it can be mounted on either the right-hand side or left-hand side of the motorcycle</i>	
 <b>BF39K</b>	Specific flange for fitting the tank bags with TANKLOCK system	
 <b>KN9050</b>	Specific engine guard, black <i>25 mm diameter steel tube / we recommend fitting by a qualified mechanic</i>	



CODICE	DESCRIZIONE	PRICE
<b>SUZUKI</b>		
<b>SUZUKI ADDRESS 110 (15 → 18)</b>		
	<b>107AK</b> Specific screen, transparent 50,8 x 66 cm (H x W) <i>to be combined with the specific A3109AK fitting kit</i>	
	<b>A3109AK</b> Specific fitting kit for 107AK	
<b>SUZUKI SIXTEEN 125-150 (08 → 16)</b>		
	<b>169AK</b> Specific screen, transparent with serigraphy 56,5 x 71,5 cm (H x W) <i>to be combined with the specific A169AK fitting kit / With hand protectors</i>	
	<b>A169AK</b> Specific fitting kit for 169AK	
<b>SUZUKI UH 125-150 BURGMAN (02 → 06)</b>		
	<b>KR114</b> Specific rear rack for <b>MONOLOCK®</b> top-case <i>to be combined with the plate already included in the MONOLOCK® top-case / it is necessary to puncture the housing behind the saddle</i>	
	<b>KD256ST</b> Specific screen, transparent 83 x 53 cm (H x W) <i>to be mounted instead of the original screen / 20 cm higher than the original / with hand protectors</i>	
<b>SUZUKI BURGMAN 125-200 K7-K8-K9-L0-L1-L2-L3 (06 → 13)</b>		
	<b>KR3106</b> Specific rear rack for <b>MONOLOCK®</b> top-case <i>to be combined with the plate already included in the MONOLOCK® top-case</i>	
	<b>3106DTK</b> Specific screen, transparent 84,5 x 65,5 cm (H x W) <i>to be combined with the specific D267KITK fitting kit / 21,5 cm higher than the original</i>	
	<b>D267KITK</b> Specific fitting kit for 3106DTK	
	<b>KD3106ST</b> Specific screen, transparent 72 x 67 cm (H x W) <i>to be mounted instead of the original screen</i>	
<b>VARIOUS ACCESSORIES</b>	<b>KT3106</b> Specific backrest <i>it is necessary to puncture the housing behind the saddle in arranged sections</i>	
<b>SUZUKI BURGMAN 125-200 ABS (14 → 18)</b>		
	<b>KR3106</b> Specific rear rack for <b>MONOLOCK®</b> top-case <i>to be combined with the plate already included in the MONOLOCK® top-case</i>	
	<b>3106DTK</b> Specific screen, transparent 84,5 x 65,5 cm (H x W) <i>to be combined with the specific D267KITK fitting kit / 21,5 cm higher than the original</i>	
	<b>D267KITK</b> Specific fitting kit for 3106DTK	
	<b>KD3106ST</b> Specific screen, transparent 72 x 67 cm (H x W) <i>to be mounted instead of the original screen</i>	
<b>VARIOUS ACCESSORIES</b>	<b>KT3106</b> Specific backrest <i>it is necessary to puncture the housing behind the saddle in arranged sections</i>	
<b>SUZUKI AN 250-400 BURGMAN (98 → 02)</b>		
	<b>KR111</b> Specific rear rack for <b>MONOKEY®</b> top-case <b>MONOKEY®</b> plate included / <i>it is necessary to puncture the housing behind the saddle</i>	
	<b>KR111M</b> Specific rear rack for <b>MONOLOCK®</b> top-case <b>MONOLOCK®</b> plate included / <i>it is necessary to puncture the housing behind the saddle</i>	
	<b>156ST</b> Specific screen, transparent 72,5 x 79,5 cm (H x W) <i>to be combined with the specific 156DK fitting kit</i>	
	<b>156DK</b> Specific fitting kit for 156S and 156ST	
<b>SUZUKI AN 250-400 BUSINESS (01 → 03)</b>		
	<b>156ST</b> Specific screen, transparent 72,5 x 79,5 cm (H x W) <i>to be combined with the specific 156DK fitting kit</i>	
	<b>156DK</b> Specific fitting kit for 156S and 156ST	

CODICE	DESCRIZIONE	PREZZO
--------	-------------	--------





**SUZUKI AN 250-400 BURGMAN (03 → 06)**

 <b>KR115</b>	Specific rear rack for <b>MONOKEY</b> ® top-case <b>MONOKEY</b> ® plate included / it is necessary to puncture the housing behind the saddle / maximum load allowed 6 kg
<b>KR1150</b>	Specific rear rack for <b>MONOLOCK</b> ® top-case <b>MONOLOCK</b> ® plate included
 <b>KD258ST</b>	Specific screen, transparent 80 x 71 cm (H x W) to be mounted instead of the original screen / 17 cm higher than the original / with hand protectors

**SUZUKI INAZUMA 250 (12 → 16)**

 <b>KR3103</b>	Specific rear rack for <b>MONOLOCK</b> ® top-case to be combined with the plate already included in the <b>MONOLOCK</b> ® top-case / it is necessary to puncture the housing behind the saddle
 <b>KL3103</b>	Specific pannier holder for <b>MONOKEY</b> ® side-cases not compatible with the side-cases in aluminium KVE37 K-venture / it can be mounted only with the specific rear rack KR3103 / you can only mount cases <b>MONOKEY</b> ® K22



**SUZUKI V-STROM 250 (17 → 18)**

 <b>KR3116</b>	Specific rear rack for <b>MONOLOCK</b> ® or <b>MONOKEY</b> ® top-case to be combined with the K636 <b>MONOKEY</b> ® plate (sold separately), or with the plate already included in the <b>MONOLOCK</b> ® top-cases
 <b>KL3116</b>	Specific pannier holder for <b>MONOKEY</b> ®, RETRO FIT side-cases
<b>KTL3116KIT</b>	Specific kit to install the KS250 Tool Box on KL3116 to be combined with KS250 and KL3116 / it can be mounted on either the right-hand side or left-hand side of the motorcycle
 <b>BF01K</b>	Specific flange for fitting the tank bags with TANKLOCK system
 <b>KN3116</b>	Specific engine guard, black 25 mm diameter steel tube / we recommend fitting by a qualified mechanic



**SUZUKI AN 400 BURGMAN TYPE-S (05)**

 <b>KD258ST</b>	Specific screen, transparent 80 x 71 cm (H x W) to be mounted instead of the original screen / 17 cm higher than the original / with hand protectors
--	---

**SUZUKI BURGMAN 400 K7-K8-K9-L0-L1-L2-L3-L4-L5-L6 (06 → 16)**

 <b>KR3115</b>	Specific rear rack for <b>MONOLOCK</b> ® or <b>MONOKEY</b> ® top-case to be combined with the <b>MONOKEY</b> ® KM5, KM8A, KM8B, KM9A or KM9B plate, or with the <b>MONOLOCK</b> ® KM5M or KM6M plate, or with the plate already included in the <b>MONOLOCK</b> ® top-cases / if combined with KM8A, KM8B it does not allow the assembly of the stop light kit or the remote control device on the case
 <b>266DTK</b>	Specific screen, transparent 84 x 68 cm (H x W) to be combined with the specific D266KITK fitting kit / 16 cm higher than the original
<b>D266KITK</b>	Specific fitting kit for 266DTK

















**SUZUKI BURGMAN 400 (17 → 18)**







 <b>KR3115</b>	Specific rear rack for <b>MONOLOCK</b> ® or <b>MONOKEY</b> ® top-case to be combined with the <b>MONOKEY</b> ® KM5, KM7, KM8A, KM8B, KM9A or KM9B plate, or with the <b>MONOLOCK</b> ® KM5M or KM6M plate, or with the plate already included in the <b>MONOLOCK</b> ® top-cases / if combined with KM8A, KM8B it does not allow the assembly of the stop light kit or the remote control device on the case
 <b>KD3115ST</b>	Specific screen, transparent 75 x 67 cm (H x W) - ABE in Vorbereitung to be mounted instead of the original screen / 21 cm higher than the original
<b>KD3115S</b>	Specific low sports screen smoked 41 x 43 cm (H x W) - ABE in Vorbereitung to be mounted instead of the original screen
<b>KAF3115</b>	Specific sliding wind-screen transparent, AIRSTREAM. Maximum height 77 cm (12 cm of extension) width 67 cm to be mounted instead of the original screen / 23 cm higher than the original
<b>VARIOUS ACCESSORIES</b> <b>KTB3115</b>	Specific backrest it cannot be mounted if rack and case are installed
<b>KHP3115</b>	Specific hands protector in ABS

**SUZUKI GS 500 E (01 → 07) / GS 500 F (04)**



 <b>K5260</b>	Specific rear rack for <b>MONOKEY</b> ® or <b>MONOLOCK</b> ® top-case To be combined with the plate <b>MONOKEY</b> ® K553N, or with the plate <b>MONOLOCK</b> ® MKN
--	--

CODICE	DESCRIZIONE	PRICE
<b>SUZUKI GSF 600 BANDIT / S (96 → 99)</b>		
 <b>K5110</b>	Specific rear rack for <b>MONOKEY®</b> or <b>MONOLOCK®</b> top-case <i>To be combined with the plate <b>MONOKEY®</b> K553N, or with the plate <b>MONOLOCK®</b> MKN</i>	
 <b>KN43</b>	Specific engine guard <i>25 mm diameter steel tube / we recommend fitting by a qualified mechanic</i>	
<b>SUZUKI GSF 600 BANDIT / S (00 → 04)</b>		
 <b>K5220</b>	Specific rear rack for <b>MONOKEY®</b> or <b>MONOLOCK®</b> top-case <i>To be combined with the plate <b>MONOKEY®</b> K553N, or with the plate <b>MONOLOCK®</b> MKN</i>	
 <b>KN43</b>	Specific engine guard <i>25 mm diameter steel tube / we recommend fitting by a qualified mechanic</i>	
<b>SUZUKI GSR 600 (06 → 11)</b>		
 <b>KR116</b>	Specific rear rack for <b>MONOKEY®</b> top-case <b>MONOKEY®</b> plate included / you must remove the grabrails / maximum load allowed 6 kg	
<b>KR116M</b>	Specific rear rack for <b>MONOLOCK®</b> top-case <b>MONOLOCK®</b> plate included / you must remove the grabrails	
 <b>KLX538</b>	Specific pannier holder for K33 <b>MONOKEY®</b> <b>SIDE</b> cases <i>it can be mounted only with the specific rear rack KR116 / KR116M</i>	
 <b>TK255</b>	Specific holder for soft side bags <i>to be mounted only with KR116 / KR116M</i>	
 <b>BF01K</b>	Specific flange for fitting the tank bags with TANKLOCK system	
 <b>245AK</b>	Universal screen, smoked 33,5 x 29 cm (W x H) <i>compatible with '06 and '07 / to be combined with the specific A167AK fitting kit</i>	
<b>245NK</b>	Universal screen, black 33,5 x 29 cm (H x W) <i>compatible with '06 and '07 / to be combined with the specific A167AK fitting kit / The inside is painted in matt colour to prevent the front light from reflecting</i>	
<b>A167AK</b>	Specific fitting kit for 245AK, 245NK <i>compatible with '06 and '07</i>	
<b>247AK</b> ↘	Universal screen, smoked 29 x 28,5 cm (H x W) <i>compatible with '08 - '11 / to be combined with the specific A170AK fitting kit</i>	
<b>247NK</b>	Specific screen, black 29 x 28,5 cm (H x W) <i>compatible with '08 - '11 / to be combined with the specific A170AK fitting kit</i>	
<b>A170AK</b>	Specific fitting kit for 247AK and 247NK <i>compatible with '08 - '11</i>	
 <b>KN535</b>	Specific engine guard <i>25 mm diameter steel tube / we recommend fitting by a qualified mechanic</i>	
<b>SUZUKI GSX 600 F (98 → 02)</b>		
 <b>K5180</b>	Specific rear rack for <b>MONOKEY®</b> or <b>MONOLOCK®</b> top-case <i>To be combined with the plate <b>MONOKEY®</b> K553N, or with the plate <b>MONOLOCK®</b> MKN</i>	
<b>SUZUKI GSX 600 F (03 → 06)</b>		
 <b>KZ530</b>	Specific rear rack for <b>MONOKEY®</b> or <b>MONOLOCK®</b> top-case <i>to be combined with the <b>MONOKEY®</b> KM5, KM7, KM8A, KM8B, KM9A or KM9B plate, or with the <b>MONOLOCK®</b> KM5M or KM6M plate / if combined with KM8A, KM8B, KM9A, KM9B it does not allow the assembly of the stop light kit or the remote control device on the case</i>	
<b>SUZUKI GSX R 600 / 750 (06 → 07)</b>		
 <b>BF01K</b>	Specific flange for fitting the tank bags with TANKLOCK system	
<b>SUZUKI GSX R 600 / 750 (08 → 10)</b>		
 <b>BF01K</b>	Specific flange for fitting the tank bags with TANKLOCK system <i>only for SUZUKI GSX R 600/750 (06 &gt; 10)</i>	
<b>SUZUKI AN 650 BURGMAN EXECUTIVE (02 → 12)</b>		
 <b>KR3104</b>	Specific rear rack for <b>MONOKEY®</b> top-case <b>MONOKEY®</b> plate included / it is necessary to puncture the housing behind the saddle in arranged sections	
<b>KR3104MM</b>	Specific rear rack for <b>MONOLOCK®</b> top-case <b>MONOLOCK®</b> plate with place for the "u" type padlock included / it is necessary to puncture the housing behind the saddle in arranged sections	



CODICE	DESCRIZIONE	PREZZO
 <b>KD257ST</b>	Specific screen, transparent 80 x 72 cm (H x W) <i>compatible with all years '02 - '04 / to be mounted instead of the original screen / With hand protectors</i>	
<b>KD263ST</b>	Specific screen, transparent 78,5 x 72 cm (H x W) <i>compatible from '05 / to be mounted instead of the original screen / made for models having electrically adjustable screen</i>	
<b>SUZUKI 650 BURGMAN / 650 BURGMAN EXECUTIVE (13 → 18)</b>		
 <b>KR3104</b>	Specific rear rack for <b>MONOKEY</b> ® top-case <b>MONOKEY</b> ® plate included / it is necessary to puncture the housing behind the saddle in arranged sections	
<b>KR3104MM</b>	Specific rear rack for <b>MONOLOCK</b> ® top-case <b>MONOLOCK</b> ® plate with place for the "u" type padlock included / it is necessary to puncture the housing behind the saddle in arranged sections	
 <b>KL3104</b>	Specific pannier holder for <b>MONOKEY</b> ® side-cases <i>it can be mounted only with the specific rear rack KR3104 / you can only mount cases <b>MONOKEY</b>® K22</i>	
 <b>KR3104KIT</b>	Specific kit to install the KR3104 on the KR3104MM on Suzuki Burgman 650 Executive (13)	
 <b>KD3104ST</b>	Specific screen, transparent 76 x 75 cm (H x W) <i>to be mounted instead of the original screen / 12 cm higher than original</i>	
<b>SUZUKI DL 650 V-STROM (04 → 11)</b>		
 <b>K528</b>	Specific rear rack for <b>MONOKEY</b> ® top-case <b>MONOKEY</b> ® plate included	
<b>K528M</b>	Specific rear rack for <b>MONOLOCK</b> ® top-case <i>to be combined with the plate already included in the <b>MONOLOCK</b>® top-case</i>	
 <b>KL532</b>	Specific pannier holder for <b>MONOKEY</b> ®, RETRO FIT side-cases	
<b>KLX532</b>	Specific pannier holder for K33 <b>MONOKEY</b> ® <b>SIDE</b> cases	
 <b>BF10K</b>	Specific flange for fitting the tank bags with TANKLOCK system	
 <b>KD260ST</b>	Specific screen, transparent 57 x 48 cm (H x W) <i>18 cm higher than original / only with spoiler / to be mounted instead of the original screen</i>	
<b>KAF260</b>	Specific Airstream sliding wind-screen, transparent Maximum height 65 cm (12 cm of extension) width 44 cm <i>to be mounted instead of the original screen</i>	
 <b>KN532</b>	Specific engine guard <i>25 mm diameter steel tube / we recommend fitting by a qualified mechanic</i>	
 <b>KMG532</b>	Specific ABS mudguard, black colour	
<b>ES3101K</b>	Specific support in aluminium and stainless steel to widen the surface support area of the original side stand	
<b>05SKITK</b>	Specific kit to mounting the KS900A Smart Bar	
<b>SUZUKI DL 650 V-STROM L2-L3-L4-L5-L6 (11 → 16)</b>		
 <b>KR3101</b>	Specific rear rack for <b>MONOKEY</b> ® top-case <b>MONOKEY</b> ® plate included	
<b>KR3101M</b>	Specific rear rack for <b>MONOLOCK</b> ® top-case <i>to be combined with the plate already included in the <b>MONOLOCK</b>® top-case</i>	
<b>KRA3101</b>	Specific rear rack in aluminium for <b>MONOKEY</b> ® top-case, black <i>maximum load allowed 6kg / it does not allow the assembly of the stop light kit or the remote control device on the case</i>	
 <b>KL3101</b>	Specific pannier holder for <b>MONOKEY</b> ® side-cases <i>not compatible with the side-cases in aluminium KVE37 K-venture</i>	
<b>KLX3101</b>	Specific pannier holder for K33 <b>MONOKEY</b> ® <b>SIDE</b> cases	
 <b>BF01K</b>	Specific flange for fitting the tank bags with TANKLOCK system	
 <b>3101DTK</b>	Specific screen, transparent 52 x 46 cm (H x W) <i>to be combined with the specific D3101KITK fitting kit</i>	
<b>D3101KITK</b>	Specific fitting kit for 3101DTK	
<b>KAF3101</b>	Specific Airstream sliding wind-screen transparent. Maximum height 56 cm (12 cm of extension), width 43 cm <i>complete with specific fitting kit / to be mounted instead of the original screen</i>	
 <b>KN3101</b>	Specific engine guard <i>25 mm diameter steel tube / we recommend fitting by a qualified mechanic / compatible with the original tip, as well as the oil carter protector RP3101K</i>	

CODICE	DESCRIZIONE	PRICE
RP3101K	Oil carter protector in Aluminium	
<b>VARIOUS ACCESSORIES</b> KMG3101	Specific ABS mudguard, black colour	
KHP3105	Specific hands protector in ABS	
ES3101K	Specific support in aluminium and stainless steel to widen the surface support area of the original side stand	
05SKITK	Specific kit to mounting the KS900A Smart Bar	
<b>SUZUKI DL 650 V-STROM (17 → 18)</b>		
 KRA3112	Specific rear rack in aluminium for <b>MONOKEY</b> ® top-case <i>maximum load allowed 6kg / it does not allow the assembly of the stop light kit or the remote control device on the case</i>	
KR3112	Specific rear rack for <b>MONOLOCK</b> ® or <b>MONOKEY</b> ® top-case <i>to be combined with the <b>MONOKEY</b>® KM5, KM7 plate, or with the <b>MONOLOCK</b>® KM5M or KM6M plate</i>	
 KL3112	Specific pannier holder for <b>MONOKEY</b> ®, RETRO FIT side-cases	
KTL3112KIT	Specific kit to install the KS250 Tool Box on KL3112 <i>to be combined with KS250 and KL3112 / you have to mount it on the left side of the motorcycle</i>	
KLR3112	Specific rapid release side-case holder for <b>MONOKEY</b> ®, RETRO FIT cases	
KLX3112	Specific pannier holder for K33 <b>MONOKEY</b> ® <b>SIDE</b> cases	
 BF01K	Specific flange for fitting the tank bags with TANKLOCK system	
 KD3112ST	Specific screen, transparent 44 x 43 cm (H x W) <i>to be mounted instead of the original screen / 12 cm higher than the original</i>	
KD3112B	Specific screen, smoked 30 x 42 cm (H x W) <i>to be mounted instead of the original screen</i>	
KAF3112	Specific sliding wind-screen transparent, Airstream. Maximum height 50 cm (12 cm of extension) width 43 cm <i>to be mounted instead of the original screen</i>	
 KN3101	Specific engine guard <i>25 mm diameter steel tube / we recommend fitting by a qualified mechanic / compatible with the original tip, as well as the oil carter protector RP3101K</i>	
RP3101K	Oil carter protector in Aluminium	
KPR3112	Stainless steel specific radiator guard black painted	
<b>VARIOUS ACCESSORIES</b> KMG532	Specific ABS mudguard, black colour	
ES3101K	Specific support in aluminium and stainless steel to widen the surface support area of the original side stand	
KFB3112	Fairing upper bracket to be mounted behind the windshield to install KS920M, KS920L and GPS-Smartphone holder <i>For KS920M, KS920L, KS952B, KS953B, KS954B, KS955B, KS956B, KS957B</i>	
05SKITK	Specific kit to mounting the KS900A Smart Bar	
<b>SUZUKI GLADIUS 650 (09 → 16)</b>		
 KR121	Specific rear rack for <b>MONOKEY</b> ® top-case <b>MONOKEY</b> ® plate included / you must remove the grabrails, they are reproduced by the rack itself / maximum load allowed 6 kg	
KR121M	Specific rear rack for <b>MONOLOCK</b> ® top-case <b>MONOLOCK</b> ® plate included / you must remove the grabrails, they are reproduced by the rack itself	
 KLX540	Specific pannier holder for K33 <b>MONOKEY</b> ® <b>SIDE</b> cases	
 BF01K	Specific flange for fitting the tank bags with TANKLOCK system	
<b>VARIOUS ACCESSORIES</b> 05SKITK	Specific kit to mounting the KS900A Smart Bar	
<b>SUZUKI GSF 650 BANDIT / BANDIT S / BANDIT ABS (05 → 06)</b>		
 KZ539	Specific rear rack for <b>MONOKEY</b> ® or <b>MONOLOCK</b> ® top-case <i>to be combined with the <b>MONOKEY</b>® KM5, KM7, KM8A, KM8B, KM9A or KM9B plate, or with the <b>MONOLOCK</b>® KM5M or KM6M plate / if combined with KM8A, KM8B, KM9A, KM9B it does not allow the assembly of the stop light kit or the remote control device on the case</i>	

CODICE	DESCRIZIONE	PREZZO
--------	-------------	--------



	<b>KD262S</b>	Specific screen, smoked 45,7 x 36,5 cm (H x W) <i>for semi faired version / to be mounted instead of the original screen / 11,7 cm higher than the original</i>
	<b>05SKITK</b>	Specific kit to mounting the KS900A Smart Bar <i>compatible with versions N / S / NA / SA (05&gt; 08)</i>

### SUZUKI GSF 650 BANDIT / GSF 650 BANDIT S K7-K8 (07 → 11)

	<b>KZ539</b>	Specific rear rack for <b>MONOKEY®</b> or <b>MONOLOCK®</b> top-case <i>IMPORTANT: since 2009 in some countries is available the model Bandit K9, while in some other countries is still sold the previous model K7-K8 / to be combined with the MONOKEY® KM5, KM7, KM8A, KM8B, KM9A or KM9B plate, or with the MONOLOCK® KM5M or KM6M plate / if combined with KM8A, KM8B, KM9A, KM9B it does not allow the assembly of the stop light kit or the remote control device on the case</i>
	<b>KL539</b>	Specific pannier holder for <b>MONOKEY®</b> , RETRO FIT side-cases <i>IMPORTANT: since 2009 in some countries is available the model Bandit K9, while in some other countries is still sold the previous model K7-K8 / you must move the indicators from their original position</i>
	<b>KLX539</b>	Specific pannier holder for K33 <b>MONOKEY® SIDE</b> cases <i>IMPORTANT: since 2009 in some countries is available the model Bandit K9, while in some other countries is still sold the previous model K7-K8 / you must move the indicators from their original position</i>
	<b>KD262S</b>	Specific screen, smoked 45,7 x 36,5 cm (H x W) <i>IMPORTANT: since 2009 in some countries is available the model Bandit K9, while in some other countries is still sold the previous model K7-K8 / to be mounted instead of the original screen / 11,7 cm higher than the original</i>





**IMPORTANT: since 2009 in some countries is available the model Bandit K9, while in some other countries is still sold the previous model K7-K8**

### SUZUKI GSF 650 BANDIT / GSF BANDIT S K9-L0-L1-L2-L3-L4 (09 → 15)



	<b>KZ540</b>	Specific rear rack for <b>MONOKEY®</b> or <b>MONOLOCK®</b> top-case <i>IMPORTANT: since 2009 in some countries is available the model Bandit K9, while in some other countries is still sold the previous model K7-K8 / to be combined with the MONOKEY® KM5, KM7, KM8A, KM8B, KM9A or KM9B plate, or with the MONOLOCK® KM5M or KM6M plate / if combined with KM8A, KM8B, KM9A, KM9B it does not allow the assembly of the stop light kit or the remote control device on the case</i>
	<b>BF01K</b>	Specific flange for fitting the tank bags with TANKLOCK system <i>IMPORTANT: since 2009 in some countries is available the model Bandit K9, while in some other countries is still sold the previous model K7-K8</i>
	<b>05SKITK</b>	Specific kit to mounting the KS900A Smart Bar <i>IMPORTANT: since 2009 in some countries is available the model Bandit K9, while in some other countries is still sold the previous model K7-K8</i>

**IMPORTANT: since 2009 in some countries is available the model Bandit K9, while in some other countries is still sold the previous model K7-K8**



### SUZUKI GSX 650 F (08 → 14) / GSX 1250 F (10 → 16)

	<b>KZ539</b>	Specific rear rack for <b>MONOKEY®</b> or <b>MONOLOCK®</b> top-case <i>to be combined with the MONOKEY® KM5, KM7, KM8A, KM8B, KM9A or KM9B plate, or with the MONOLOCK® KM5M or KM6M plate / if combined with KM8A, KM8B, KM9A, KM9B it does not allow the assembly of the stop light kit or the remote control device on the case</i>
	<b>KL539</b>	Specific pannier holder for <b>MONOKEY®</b> , RETRO FIT side-cases <i>you must move the indicators from their original position</i>
	<b>KLX539</b>	Specific pannier holder for K33 <b>MONOKEY® SIDE</b> cases <i>you must move the indicators from their original position</i>
	<b>BF01K</b>	Specific flange for fitting the tank bags with TANKLOCK system
	<b>KD270S</b>	Specific screen, smoked 45 x 38,5 cm (H x W) <i>to be mounted instead of the original screen / 10,5 cm higher than the original</i>
	<b>05SKITK</b>	Specific kit to mounting the KS900A Smart Bar















### SUZUKI SV 650 / SV 650 S (03 → 08)

	<b>KZ529</b>	Specific rear rack for <b>MONOKEY®</b> or <b>MONOLOCK®</b> top-case <i>to be combined with the MONOKEY® KM5, KM7, KM8A, KM8B, KM9A or KM9B plate, or with the MONOLOCK® KM5M or KM6M plate / if combined with KM8A, KM8B, KM9A, KM9B it does not allow the assembly of the stop light kit or the remote control device on the case</i>
	<b>BF01K</b>	Specific flange for fitting the tank bags with TANKLOCK system





### SUZUKI SV 650 (16 → 18)

	<b>KZ3111</b>	Specific rear rack for <b>MONOKEY®</b> or <b>MONOLOCK®</b> top-case <i>to be combined with the MONOKEY® KM5, KM7, KM8A, KM8B, KM9A or KM9B plate, or with the MONOLOCK® KM5M or KM6M plate / if combined with KM8A, KM8B, KM9A, KM9B it does not allow the assembly of the stop light kit or the remote control device on the case</i>
	<b>KLX3111</b>	Specific pannier holder for K33 <b>MONOKEY® SIDE</b> cases <i>it can be mounted only with the specific rear rack KZ3111 / you must move the indicators from their original position</i>
	<b>BF01K</b>	Specific flange for fitting the tank bags with TANKLOCK system







CODICE	DESCRIZIONE	PRICE
 <b>KA3111</b>	Specific screen, smoked 28,5 x 36 cm (H x L) <i>complete with specific fitting kit</i>	
 <b>KPR3111</b>	Stainless steel specific radiator guard black painted	
<b>VARIOUS ACCESSORIES</b> <b>KHP3111</b>	Specific hands protector in ABS	
<b>05SKITK</b>	Specific kit to mounting the KS900A Smart Bar	
<b>SUZUKI GSX 750 (98 → 02)</b>		
 <b>K5170</b>	Specific rear rack for <b>MONOKEY</b> ® or <b>MONOLOCK</b> ® top-case <i>To be combined with the plate <b>MONOKEY</b>® K553N, or with the plate <b>MONOLOCK</b>® MKN</i>	
 <b>KN43</b>	Specific engine guard <i>25 mm diameter steel tube / we recommend fitting by a qualified mechanic</i>	
<b>SUZUKI GSX 750 F (98 → 02)</b>		
 <b>K5180</b>	Specific rear rack for <b>MONOKEY</b> ® or <b>MONOLOCK</b> ® top-case <i>To be combined with the plate <b>MONOKEY</b>® K553N, or with the plate <b>MONOLOCK</b>® MKN</i>	
<b>SUZUKI GSX 750 F (03 → 06)</b>		
 <b>KZ530</b>	Specific rear rack for <b>MONOKEY</b> ® or <b>MONOLOCK</b> ® top-case <i>to be combined with the <b>MONOKEY</b>® KM5, KM7, KM8A, KM8B, KM9A or KM9B plate, or with the <b>MONOLOCK</b>® KM5M or KM6M plate / if combined with KM8A, KM8B, KM9A, KM9B it does not allow the assembly of the stop light kit or the remote control device on the case</i>	
<b>SUZUKI GSX S750 (17 → 18)</b>		
 <b>KZ3113</b>	Specific rear rack for <b>MONOKEY</b> ® or <b>MONOLOCK</b> ® top-case <i>to be combined with the <b>MONOKEY</b>® KM5, KM7, KM8A, KM8B, KM9A or KM9B plate, or with the <b>MONOLOCK</b>® KM5M or KM6M plate / if combined with KM8A, KM8B, KM9A, KM9B it does not allow the assembly of the stop light kit or the remote control device on the case / maximum load allowed 6 kg</i>	
 <b>3113KITK</b>	Specific kit to install the TST3113 without the specific rear rack KZ3113	
 <b>BF01K</b>	Specific flange for fitting the tank bags with TANKLOCK system	
 <b>KA3113</b>	Specific screen, smoked 28 x 36,5 cm (H x W) <i>complete with specific fitting kit</i>	
<b>KA3113BL</b>	Specific BLUE LINE screen 28 x 36,5 cm (H x W) <i>complete with specific fitting kit / when illuminated by vehicle headlights in low light conditions, the edge glows blue in colour</i>	
<b>VARIOUS ACCESSORIES</b> <b>KHP3113</b>	Specific hands protector in ABS	
<b>03SKITK</b>	Specific kit to mounting the KS900A Smart Bar	
<b>SUZUKI GSR 750 (11 → 16)</b>		
 <b>KZ3100</b>	Specific rear rack for <b>MONOKEY</b> ® or <b>MONOLOCK</b> ® top-case <i>to be combined with the <b>MONOKEY</b>® KM5, KM7, KM8A, KM8B, KM9A or KM9B plate, or with the <b>MONOLOCK</b>® KM5M or KM6M plate / if combined with KM8A, KM8B, KM9A, KM9B it does not allow the assembly of the stop light kit or the remote control device on the case</i>	
 <b>TE3100K</b> ↘	Specific holder for soft side bags or for semi-rigid side bags (RA314) <i>it can be mounted without the specific rear rack KZ3100 using the 3100KIT / you must move the indicators from their original position</i>	
 <b>BF01K</b>	Specific flange for fitting the tank bags with TANKLOCK system	
<b>VARIOUS ACCESSORIES</b> <b>05SKITK</b>	Specific kit to mounting the KS900A Smart Bar	
<b>SUZUKI DL 1000 V-STROM (02 → 11)</b>		
 <b>K528</b>	Specific rear rack for <b>MONOKEY</b> ® top-case <b>MONOKEY</b> ® plate included	
<b>K528M</b>	Specific rear rack for <b>MONOLOCK</b> ® top-case <i>to be combined with the plate already included in the <b>MONOLOCK</b>® top-case</i>	
 <b>KL528</b>	Specific pannier holder for <b>MONOKEY</b> ®, RETRO FIT side-cases	
<b>KLX528</b>	Specific pannier holder for K33 <b>MONOKEY</b> ® SIDE cases	





CODICE	DESCRIZIONE	PREZZO
--------	-------------	--------

	<b>TKB09</b> ↘ Specific "Tanky" base for Suzuki DL V-Storm (04-10), compatible with the tank bags TKB751 - TKB754	
	<b>BF10K</b> Specific flange for fitting the tank bags with TANKLOCK system	
	<b>KD260ST</b> Specific screen, transparent 57 x 48 cm (H x W) <i>compatible from year '04 / 18 cm higher than original / only with spoiler / to be mounted instead of the original screen</i>	
	<b>KAF260</b> Specific Airstream sliding wind-screen, transparent Maximum height 65 cm (12 cm of extension) width 44 cm <i>compatible from year '04 / to be mounted instead of the original screen</i>	
	<b>KN46</b> Specific engine guard <i>25 mm diameter steel tube / we recommend fitting by a qualified mechanic</i>	





### SUZUKI DL 1000 V-STROM (14 → 16)



	<b>KR3105</b> Specific rear rack for <b>MONOKEY</b> ® top-case <i>maximum load allowed 6 kg / MONOKEY® plate included</i>	
	<b>KRA3105</b> Specific rear rack in aluminium for <b>MONOKEY</b> ® top-case <i>maximum load allowed 6kg / it does not allow the assembly of the stop light kit or the remote control device on the case</i>	
	<b>KR3105M</b> Specific rear rack for <b>MONOLOCK</b> ® top-case <b>MONOLOCK</b> ® plate included	
	<b>KLR3105</b> Specific rapid release side-case holder for <b>MONOKEY</b> ®, RETRO FIT cases	
	<b>BF18K</b> Specific flange for fitting the tank bags with TANKLOCK system	
	<b>KD3105ST</b> Specific screen, transparent 50 x 39,5 cm (h x w) <i>to be mounted instead of the original screen / 22 cm higher than original</i>	
	<b>KAF3105</b> Specific sliding wind-screen transparent, <b>AIRSTREAM</b> ®. Maximum height 50 cm (12 cm of extension) width 41 cm <i>to be mounted instead of the original screen</i>	
	<b>KN3105</b> Specific engine guard <i>25 mm diameter steel tube / we recommend fitting by a qualified mechanic / black colour</i>	
	<b>RP3105K</b> Oil carter protector in Aluminium	
	<b>KPR3105</b> Stainless steel specific radiator guard black painted	
<b>VARIOUS ACCESSORIES</b>	<b>KMG3105</b> Specific ABS mudguard, black colour	
	<b>KHP3105</b> Specific hands protector in ABS	
	<b>ES3105K</b> Specific support in aluminium and stainless steel to widen the surface support area of the original side stand	
	<b>KFB3114</b> Fairing upper bracket to be mounted behind the windshield to install KS920M, KS920L and GPS-Smartphone holder <i>For KS920M, KS920L, KS952B, KS953B, KS954B, KS955B, KS956B, KS957B</i>	
	<b>02SKITK</b> Specific kit to mounting the KS900A Smart Bar	

### SUZUKI DL 1000 V-STROM (17 → 18)

	<b>KRA3112</b> Specific rear rack in aluminium for <b>MONOKEY</b> ® top-case <i>maximum load allowed 6kg / it does not allow the assembly of the stop light kit or the remote control device on the case</i>	
	<b>KR3112</b> Specific rear rack for <b>MONOLOCK</b> ® or <b>MONOKEY</b> ® top-case <i>to be combined with the MONOKEY® KM5, KM7 plate, or with the MONOLOCK® KM5M or KM6M plate</i>	
	<b>KLR3105</b> Specific rapid release side-case holder for <b>MONOKEY</b> ®, RETRO FIT cases	
	<b>KTL3112KIT</b> Specific kit to install the KS250 Tool Box on KLR3105 <i>to be combined with KS250 and KL3105 / you have to mount it on the left side of the motorcycle</i>	
	<b>KLXR3114</b> Specific rapid release side-case holder for K33 <b>MONOKEY</b> ® <b>SIDE</b> cases	
	<b>BF18K</b> Specific flange for fitting the tank bags with TANKLOCK system	
	<b>KD3105ST</b> Specific screen, transparent 50 x 39,5 cm (h x w) <i>to be mounted instead of the original screen / 22 cm higher than original</i>	
	<b>KAF3105</b> Specific sliding wind-screen transparent, <b>AIRSTREAM</b> ®. Maximum height 50 cm (12 cm of extension) width 41 cm <i>to be mounted instead of the original screen</i>	
	<b>KN3105</b> Specific engine guard <i>25 mm diameter steel tube / we recommend fitting by a qualified mechanic / black colour</i>	
	<b>RP3105K</b> Oil carter protector in Aluminium	

CODICE	DESCRIZIONE	PRICE
<b>KPR3105</b>	Stainless steel specific radiator guard black painted	
<b>VARIOUS ACCESSORIES</b> <b>KRM01</b>	Universal spray guard <i>It needs to be paired with the specific mounting kit (RM3114KITK)</i>	
<b>KRM02</b>	Universal spray guard <i>It needs to be paired with the specific mounting kit (RM3114KITK)</i>	
<b>RM3114KITK</b>	Specific kit for spray guard KRM01, KRM02	
<b>KMG3114</b>	Specific ABS mudguard, black colour	
<b>KHP3105</b>	Specific hands protector in ABS	
<b>ES3105K</b>	Specific support in aluminium and stainless steel to widen the surface support area of the original side stand	
<b>KFB3114</b>	Fairing upper bracket to be mounted behind the windshield to install KS920M, KS920L and GPS-Smartphone holder <i>For KS920M, KS920L, KS952B, KS953B, KS954B, KS955B, KS956B, KS957B</i>	
<b>02SKITK</b>	Specific kit to mounting the KS900A Smart Bar	
<b>SUZUKI</b>	<b>GSX R 1000 (09 → 12)</b>	
 <b>BF01K</b>	Specific flange for fitting the tank bags with TANKLOCK system	
<b>SUZUKI</b>	<b>SV 1000 / SV 1000 S (03 → 07)</b>	
 <b>KZ529</b>	Specific rear rack for <b>MONOKEY®</b> or <b>MONOLOCK®</b> top-case <i>to be combined with the MONOKEY® KM5, KM7, KM8A, KM8B, KM9A or KM9B plate, or with the MONOLOCK® KM5M or KM6M plate / if combined with KM8A, KM8B, KM9A, KM9B it does not allow the assembly of the stop light kit or the remote control device on the case</i>	
 <b>BF01K</b>	Specific flange for fitting the tank bags with TANKLOCK system	
<b>SUZUKI</b>	<b>GSX S 1000 F / GSX S 1000 (15 → 18)</b>	
 <b>KZ3110</b>	Specific rear rack for <b>MONOKEY®</b> or <b>MONOLOCK®</b> top-case <i>to be combined with the MONOKEY® KM5, KM7, KM8A, KM8B, KM9A or KM9B plate, or with the MONOLOCK® KM5M or KM6M plate / if combined with KM8A, KM8B, KM9A, KM9B it does not allow the assembly of the stop light kit or the remote control device on the case / maximum load allowed 6 kg</i>	
 <b>TST3110K</b>	Specific holder for soft side bags <i>it can be mounted without the specific rear rack KZ3110 using the 3110KITK</i>	
 <b>3110KITK</b>	Specific kit to install the TST3110 without the specific rear rack KZ3110	
 <b>BF18K</b>	Specific flange for fitting the tank bags with TANKLOCK system	
 <b>KD3110ST</b>	Specific screen, transparent 59 x 35 cm (H x W) <i>only for version GSX S1000F / to be mounted instead of the original screen / 15 cm higher than the original</i>	
<b>VARIOUS ACCESSORIES</b> <b>05SKITK</b>	Specific kit to mounting the KS900A Smart Bar	
<b>SUZUKI</b>	<b>GSX 1200 (98 → 02)</b>	
 <b>K5170</b>	Specific rear rack for <b>MONOKEY®</b> or <b>MONOLOCK®</b> top-case <i>To be combined with the plate MONOKEY® K553N, or with the plate MONOLOCK® MKN</i>	
<b>SUZUKI</b>	<b>GSF 1200 BANDIT (96 → 99)</b>	
 <b>K5110</b>	Specific rear rack for <b>MONOKEY®</b> or <b>MONOLOCK®</b> top-case <i>To be combined with the plate MONOKEY® K553N, or with the plate MONOLOCK® MKN</i>	
<b>SUZUKI</b>	<b>GSF 1200 BANDIT / BANDIT S (00 → 05)</b>	
 <b>K5220</b>	Specific rear rack for <b>MONOKEY®</b> or <b>MONOLOCK®</b> top-case <i>To be combined with the plate MONOKEY® K553N, or with the plate MONOLOCK® MKN</i>	
<b>SUZUKI</b>	<b>GSF 1200 BANDIT / BANDIT S (06)</b>	
 <b>KZ539</b>	Specific rear rack for <b>MONOKEY®</b> or <b>MONOLOCK®</b> top-case <i>to be combined with the MONOKEY® KM5, KM7, KM8A, KM8B, KM9A or KM9B plate, or with the MONOLOCK® KM5M or KM6M plate / if combined with KM8A, KM8B, KM9A, KM9B it does not allow the assembly of the stop light kit or the remote control device on the case</i>	

CODICE	DESCRIZIONE	PREZZO
 <b>KD262S</b>	Specific screen, smoked 45,7 x 36,5 cm (H x W) <i>to be mounted instead of the original screen / 11,7 cm higher than the original</i>	
<b>SUZUKI GSF 1250 BANDIT / BANDIT S (07 → 11)</b>		
 <b>KZ539</b>	Specific rear rack for <b>MONOKEY®</b> or <b>MONOLOCK®</b> top-case <i>to be combined with the MONOKEY® KM5, KM7, KM8A, KM8B, KM9A or KM9B plate, or with the MONOLOCK® KM5M or KM6M plate / if combined with KM8A, KM8B, KM9A, KM9B it does not allow the assembly of the stop light kit or the remote control device on the case</i>	
 <b>KL539</b>	Specific pannier holder for <b>MONOKEY®</b> , RETRO FIT side-cases <i>you must move the indicators from their original position</i>	
<b>KLX539</b>	Specific pannier holder for K33 <b>MONOKEY® SIDE</b> cases <i>you must move the indicators from their original position</i>	
 <b>245NK</b>	Universal screen, black 33,5 x 29 cm (H x W) <i>to be combined with the specific A168A fitting kit</i>	
<b>KD262S</b>	Specific screen, smoked 45,7 x 36,5 cm (H x W) <i>to be mounted instead of the original screen / 11,7 cm higher than the original</i>	
<b>VARIOUS ACCESSORIES</b> <b>05SKITK</b>	Specific kit to mounting the KS900A Smart Bar	







<b>SUZUKI GSX 1250 F (10)</b>		
 <b>BF01K</b>	Specific flange for fitting the tank bags with TANKLOCK system	
<b>SUZUKI GSX 1300R HAYABUSA (08 → 16)</b>		
 <b>KZ541</b>	Specific rear rack for <b>MONOKEY®</b> or <b>MONOLOCK®</b> top-case <i>to be combined with the MONOKEY® KM5, KM7, KM8A, KM8B, KM9A or KM9B plate, or with the MONOLOCK® KM5M or KM6M plate / if combined with KM8A, KM8B, KM9A, KM9B it does not allow the assembly of the stop light kit or the remote control device on the case / a handle bar for the passenger is included, you must remove the original grab rails / maximum load allowed 6 kg</i>	
 <b>BF01K</b>	Specific flange for fitting the tank bags with TANKLOCK system	

<b>SUZUKI GSX 1400 (02 → 09)</b>		
 <b>KZ527</b>	Specific rear rack for <b>MONOKEY®</b> or <b>MONOLOCK®</b> top-case <i>to be combined with the MONOKEY® KM5, KM7, KM8A, KM8B, KM9A or KM9B plate, or with the MONOLOCK® KM5M or KM6M plate / if combined with KM8A, KM8B, KM9A, KM9B it does not allow the assembly of the stop light kit or the remote control device on the case</i>	









<b>SYM</b>		
<b>SYM FIDDLE II 50-125 (09 → 14)</b>		
<b>K628</b>	Universal plate included in <b>MONOLOCK®</b> top-cases box. <i>You can fit a Monolock® top-case using the universal plate included.</i>	
 <b>293AK</b>	Specific screen, transparent 50 x 63 cm (H x W) <i>to be combined with the specific A293AK fitting kit</i>	
<b>A293AK</b>	Specific fitting kit for 293AK	













<b>SYM SYMPHONY S 50-125-151 (09 → 18) / SYMPHONY S 50-125-150 (09 → 15)</b>		
 <b>A295AK</b>	Specific fitting kit for 294A and 296A <i>Only for 125 cc. version / only for 09-10</i>	
<b>107AK</b>	Specific screen, transparent 50,8 x 66 cm (H x W) <i>only available if article A299A is already fitted</i>	
<b>7053AK</b>	Specific screen, transparent with serigraphy. 52,5 x 76 cm (H x W) <i>to be combined with the specific A7053AK fitting kit</i>	
<b>A7053AK</b>	Specific fitting kit for 7053AK	

CODICE	DESCRIZIONE	PRICE
<b>SYM SYMPHONY SR 50-125-151 (10 → 16)</b>		
 <b>297AK</b>	Specific screen, transparent 62 x 71 cm (H x W) <i>to be combined with the specific A297AK fitting kit</i>	
<b>A297AK</b>	Specific fitting kit for 297AK	
<b>SYM SYMPHONY ST 50-125-200 (15 → 18)</b>		
 <b>KR7054</b>	Specific rear rack for <b>MONOLOCK®</b> top-case <i>to be combined with the plate already included in the MONOLOCK® top-case</i>	
 <b>7054AK</b>	Specific screen, transparent 49 x 66 cm (H x W) <i>to be combined with the specific A7054AK fitting kit</i>	
<b>A7054AK</b>	Specific fitting kit for 7054AK	
<b>SYM JET 14 125-200 (17 → 18)</b>		
 <b>KR7055</b>	Specific rear rack for <b>MONOLOCK®</b> top-case <i>to be combined with the plate already included in the MONOLOCK® top-case</i>	
<b>SYM JOYRIDE EVO 125-200 (09 → 18)</b>		
 <b>KR233</b>	Specific rear rack for <b>MONOKEY®</b> top-case <b>MONOKEY®</b> plate included / maximum load allowed 6 kg	
<b>KR2330</b>	Specific rear rack for <b>MONOLOCK®</b> top-case <b>MONOLOCK®</b> plate included	
 <b>KD651ST</b>	Specific screen, transparent 62 x 60 cm (H x W) <i>to be mounted instead of the original screen / 15,5 cm higher than original</i>	
<b>SYM HD EVO 125-200 (07 → 16)</b>		
 <b>128AK</b>	Specific screen, transparent 74 x 67 cm (H x W) <i>to be combined with the specific A298AK fitting kit / 8 cm higher than 105AK</i>	
<b>105AK</b>	Specific screen, transparent 66 x 67 cm (H x W) <i>to be combined with the specific A298AK fitting kit</i>	
<b>A298AK</b>	Specific fitting kit for 105AK and 128AK	
<b>SYM HD2 125-200 (11 → 16)</b>		
 <b>105AK</b>	Specific screen, transparent 66 x 67 cm (H x W) <i>to be combined with the specific A7050AK fitting kit</i>	
<b>128AK</b>	Specific screen, transparent 74 x 67 cm (H x W) <i>to be combined with the specific A7050AK fitting kit / 8 cm higher than 105AK</i>	
<b>A7050AK</b>	Specific fitting kit for 105AK and 128AK	
<b>SYM JOYMAX 250 (05 → 08) / JOYMAX EVO (09 → 11) / GTS (11→02)</b>		
 <b>KR230</b>	Specific rear rack for <b>MONOLOCK®</b> or <b>MONOKEY®</b> top-case <i>to be combined with the K636 MONOKEY® plate (sold separately), or with the plate already included in the MONOLOCK® top-cases</i>	
<b>KR2320</b>	Specific rear rack for <b>MONOLOCK®</b> top-case <i>to be combined with the plate already included in the MONOLOCK® top-case</i>	
<b>SYM CITYCOM 300 (08 → 18)</b>		
 <b>KR2310</b>	Specific rear rack for <b>MONOLOCK®</b> top-case <i>to be combined with the plate already included in the MONOLOCK® top-case / you must puncture the housing behind the saddle in arranged sections</i>	
 <b>KD650ST</b>	Specific screen, transparent 64 x 55 cm (H x W) <i>to be mounted instead of the original screen / 19 cm higher than original</i>	
<b>SYM JOYMAX 300I (12 → 18)</b>		
 <b>KR7052</b>	Specific rear rack for <b>MONOKEY®</b> top-case <i>maximum load allowed 6 kg / MONOKEY® plate included</i>	

CODICE	DESCRIZIONE	PREZZO
 <b>KR7052M</b>	Specific rear rack for <b>MONOLOCK</b> <sup>®</sup> top-case <i>to be combined with the plate already included in the <b>MONOLOCK</b><sup>®</sup> top-case</i>	
 <b>KD7052ST</b>	Specific screen, transparent with handguards 82 x 59 cm (H x W) <i>to be mounted instead of the original screen / 16,5 cm higher than the original</i>	
<b>SYM CRUISYM 300 (17 → 18)</b>		
 <b>KR7056</b>	Specific rear rack for <b>MONOLOCK</b> <sup>®</sup> or <b>MONOKEY</b> <sup>®</sup> top-case <i>to be combined with the <b>MONOKEY</b><sup>®</sup> KM5, KM8A, KM8B, KM9A or KM9B plate, or with the <b>MONOLOCK</b><sup>®</sup> KM5M or KM6M plate or with the plate already included in the <b>MONOLOCK</b><sup>®</sup> top-cases / if combined with KM8A, KM8B, KM9A, KM9B it does not allow the assembly of the stop light kit or the remote control device on the case / maximum load allowed 6 kg</i>	
 <b>7056DTK</b>	Specific screen, transparent 78 x 70,5 cm (H x W) <i>to be combined with the specific D7056KITK fitting kit / 21 cm higher than the original</i>	
<b>D7056KITK</b>	Specific fitting kit for 7056DTK	
<b>VARIOUS ACCESSORIES</b> <b>KTB7056</b>	Specific backrest <i>it cannot be mounted with Monorack KR7056</i>	
<b>SYM MAXSYM 400-600 (11 → 18)</b>		
 <b>KR7051</b>	Specific rear rack for <b>MONOKEY</b> <sup>®</sup> top-case <b>MONOKEY</b> <sup>®</sup> plate included	
<b>KR7051M</b>	Specific rear rack for <b>MONOLOCK</b> <sup>®</sup> top-case <b>MONOLOCK</b> <sup>®</sup> plate included	
 <b>7051DTK</b>	Specific screen, transparent 74 x 64 cm (H x W) <i>to be combined with the specific D7051KITK fitting kit / 12 cm higher than original</i>	
<b>D7051KITK</b>	Specific fitting kit for 7051DTK	

## TRIUMPH

<b>TRIUMPH DAYTONA 675</b>		
 <b>BF02K</b>	Specific flange for fitting the tank bags with TANKLOCK system	
<b>TRIUMPH STREET TRIPLE 675 (07 → 12)</b>		
 <b>KZ727</b>	Specific rear rack for <b>MONOKEY</b> <sup>®</sup> or <b>MONOLOCK</b> <sup>®</sup> top-case <i>to be combined with the <b>MONOKEY</b><sup>®</sup> KM5, KM7, KM8A, KM8B, KM9A or KM9B plate, or with the <b>MONOLOCK</b><sup>®</sup> KM5M or KM6M plate / if combined with KM8A, KM8B, KM9A, KM9B it does not allow the assembly of the stop light kit or the remote control device on the case / maximum load allowed 6 kg</i>	
 <b>TE705K</b>	Specific holder for soft side bags or for semi-rigid side bags (RA314)	
 <b>BF02K</b>	Specific flange for fitting the tank bags with TANKLOCK system	
 <b>247NK</b>	Specific screen, black 29 x 28,5 cm (H x W) <i>only available if article A221A is already fitted</i>	
 <b>KN226</b>	Specific engine guard <i>25 mm diameter steel tube / we recommend fitting by a qualified mechanic / chromed</i>	
<b>TRIUMPH STREET TRIPLE 675 (13 → 16)</b>		
 <b>BF02K</b>	Specific flange for fitting the tank bags with TANKLOCK system	
 <b>TE6405K</b>	Specific holder for soft side bags or for semi-rigid side bags (RA314)	
<b>TRIUMPH STREET TRIPLE 765 (17 → 18)</b>		
 <b>KZ6412</b>	Specific rear rack for <b>MONOKEY</b> <sup>®</sup> or <b>MONOLOCK</b> <sup>®</sup> top-case <i>to be combined with the <b>MONOKEY</b><sup>®</sup> KM5, KM7, KM8A, KM8B, KM9A or KM9B plate, or with the <b>MONOLOCK</b><sup>®</sup> KM5M or KM6M plate / if combined with KM8A, KM8B, KM9A, KM9B it does not allow the assembly of the stop light kit or the remote control device on the case / maximum load allowed 6 kg</i>	

CODICE	DESCRIZIONE	PRICE
 <b>TST6412K</b>	Specific holder for soft side bags	
 <b>BF02K</b>	Specific flange for fitting the tank bags with TANKLOCK system	
<b>VARIOUS ACCESSORIES</b> <b>KRM01</b>	Universal spray guard <i>It needs to be paired with the specific mounting kit (RM6412KITK)</i>	
<b>KRM02</b>	Universal spray guard <i>It needs to be paired with the specific mounting kit (RM6412KITK)</i>	
<b>RM6412KITK</b>	Specific kit for spray guard KRM01, KRM02	
<b>KHP6412</b>	Specific hands protector in ABS	
<b>05SKITK</b>	Specific kit to mounting the KS900A Smart Bar <i>for S / R / RS version</i>	
<b>TRIUMPH</b>	<b>TIGER 800 / 800 XC / 800 XR (11 → 17)</b>	
 <b>KR6401</b>	Specific rear rack for <b>MONOKEY</b> ® top-case <i>maximum load allowed 6 kg / MONOKEY® plate included / it is necessary to puncture the housing behind the saddle</i>	
<b>KRA6401</b>	Specific rear rack in aluminium for <b>MONOKEY</b> ® top-case <i>maximum load allowed 6kg / it does not allow the assembly of the stop light kit or the remote control device on the case / you must puncture the housing in arranged sections</i>	
 <b>KLR6409</b>	Specific rapid release side-case holder for <b>MONOKEY</b> ®, RETRO FIT cases	
<b>KTL1146KIT</b>	Specific kit to install the KS250 Tool Box on KLR6409 <i>to be combined with KS250 and KLR6409 / needs to be mounted on the left-hand side of the motorcycle</i>	
 <b>BF02K</b>	Specific flange for fitting the tank bags with TANKLOCK system	
 <b>6401DTK</b> ↘	Specific screen, transparent 53 x 46,5 cm (H x W) <i>not compatible on version with a height adjustable windshield / to be combined with the specific D6401KITK fitting kit / 17 cm higher than original</i>	
<b>D6401KITK</b> ↘	Specific fitting kit for 6401DTK <i>not compatible on version with a height adjustable windshield</i>	
<b>KAF6401</b>	Specific Airstream sliding wind-screen transparent. Maximum height 60,5 cm (12 cm of extension), width 45,5 cm <i>not compatible on version with a height adjustable windshield / complete with specific fitting kit / to be mounted instead of the original screen</i>	
 <b>KN6409</b>	Specific engine guard, black <i>for 2011 version to be combined with the kit KN6401AKIT / 25 mm diameter steel tube / we recommend fitting by a qualified mechanic</i>	
<b>KN6401AKIT</b>	Specific kit to install the KN6401 / KN6409 on Tiger 800 / Tiger 800 XC / Tiger XR (11)	
<b>VARIOUS ACCESSORIES</b> <b>KMG6401</b>	Specific ABS mudguard, black colour	
<b>ES6401K</b>	Specific support in aluminium and stainless steel to widen the surface support area of the original side stand <i>it is not compatible with central tripod</i>	
<b>01SKITK</b>	Specific kit to mounting the KS900A Smart Bar	
<b>TRIUMPH</b>	<b>TIGER 800 XC / 800 XR (18) NEW</b>	
 <b>KR6401</b>	Specific rear rack for <b>MONOKEY</b> ® top-case <i>maximum load allowed 6 kg / MONOKEY® plate included / it is necessary to puncture the housing behind the saddle</i>	
<b>KRA6401</b>	Specific rear rack in aluminium for <b>MONOKEY</b> ® top-case <i>maximum load allowed 6kg / it does not allow the assembly of the stop light kit or the remote control device on the case / you must puncture the housing in arranged sections</i>	
 <b>KLR6413</b>	Specific rapid release side-case holder for <b>MONOKEY</b> ®, RETRO FIT cases	
<b>VARIOUS ACCESSORIES</b> <b>KTL8705KIT</b>	Specific kit to install the KS250 Tool Box on KLR6413 <i>to be combined with KS250 and KLR6413 / needs to be mounted on the left-hand side of the motorcycle</i>	
 <b>BF02K</b>	Specific flange for fitting the tank bags with TANKLOCK system	
 <b>KD6413S</b>	Specific screen, smoked 47 x 41 cm (H x W) <i>to be mounted instead of the original screen / 2 cm higher than the original</i>	
<b>KD6413ST</b>	Specific screen, transparent 58,5 x 43,5 cm (H x W) <i>to be mounted instead of the original screen / 14,5 cm higher than the original</i>	
 <b>KN6409</b>	Specific engine guard, black <i>25 mm diameter steel tube / we recommend fitting by a qualified mechanic</i>	
<b>VARIOUS ACCESSORIES</b> <b>KMG6401</b>	Specific ABS mudguard, black colour	

CODICE	DESCRIZIONE	PREZZO
--------	-------------	--------

**LS6413K** Specific fitting kit to mount KS310 or KS322 spotlights  
*only for Tiger 800 XC*

**01SKITK** Specific kit to mounting the KS900A Smart Bar

### TRIUMPH BONNEVILLE 865

 **KR2260** Specific rear chromed rack for **MONOLOCK®** or **MONOKEY®** top-case  
*to be combined with the K636 MONOKEY® plate (sold separately), or with the plate already included in the MONOLOCK® top-cases*

 **100ALK** Grey anodized aluminium universal screen Race Cafe, for naked motorcycles 20,5 x 26,5 cm (H x W)  
*to be combined with the specific AL6406AK fitting kit*

**100ALBK** Black anodized aluminium universal screen Race Cafe, for naked motorcycles 20,5 x 26,5 cm (H x W)  
*to be combined with the specific AL6406AK fitting kit*

**140AK** Universal transparent screen 35 x 41cm (H x W)  
*to be combined with the specific AL6406AK fitting kit*

**140SK** Universal smoked screen 35 x 41 cm (H x W)  
*to be combined with the specific AL6406AK fitting kit*

**AL6406AK** Specific fitting kit for 100ALK, 100ALBK, 140AK, 140SK  
*only compatible with Bonneville 865 T100*

### TRIUMPH STREET TWIN 900 (16 → 18)

 **KR6407** Specific rear black rack for **MONOLOCK®** or **MONOKEY®** top-case  
*to be combined with the K636 MONOKEY® plate (sold separately), or with the plate already included in the MONOLOCK® top-cases*

 **TMT6407K** Specific holder for soft side bags or for a pair of CR601U side bags

 **100ALBK** Black anodized aluminium universal screen Race Cafe, for naked motorcycles 20,5 x 26,5 cm (H x W)  
*to be combined with the specific AL6407AK fitting kit*

**100ALK** Grey anodized aluminium universal screen Race Cafe, for naked motorcycles 20,5 x 26,5 cm (H x W)  
*to be combined with the specific AL6407AK fitting kit*

**140AK** Universal transparent screen 35 x 41cm (H x W)  
*to be combined with the specific AL6407AK fitting kit*

**140SK** Universal smoked screen 35 x 41 cm (H x W)  
*to be combined with the specific AL6407AK fitting kit*

**AL6407AK** Specific fitting kit for 100ALK, 100ALBK, 140AK, 140SK

 **KN6410** Specific engine guard, black  
*25 mm diameter steel tube / we recommend fitting by a qualified mechanic*

**VARIOUS ACCESSORIES 05SKITK** Specific kit to mounting the KS900A Smart Bar

### TRIUMPH STREET SCRAMBLER 900 (17 → 18)

**VARIOUS ACCESSORIES 05SKITK** Specific kit to mounting the KS900A Smart Bar

### TRIUMPH BONNEVILLE T100 (17 → 18)

 **KR6410** Specific rear black rack for **MONOLOCK®** or **MONOKEY®** top-case  
*to be combined with the K636 MONOKEY® plate (sold separately), or with the plate already included in the MONOLOCK® top-cases*

 **KL6410** Specific pannier holder for **MONOKEY®**, RETRO FIT side-cases  
*can only be mounted with the KR6410*

 **TMT6407K** Specific holder for soft side bags or for a pair of CR601U side bags

 **100ALK** Grey anodized aluminium universal screen Race Cafe, for naked motorcycles 20,5 x 26,5 cm (H x W)  
*to be combined with the specific AL6410AK fitting kit*

**100ALBK** Black anodized aluminium universal screen Race Cafe, for naked motorcycles 20,5 x 26,5 cm (H x W)  
*to be combined with the specific AL6410AK fitting kit*



**140AK** Universal transparent screen 35 x 41cm (H x W)  
*to be combined with the specific AL6410AK fitting kit*



**140SK** Universal smoked screen 35 x 41 cm (H x W)  
*to be combined with the specific AL6410AK fitting kit*



**AL6410AK** Specific fitting kit for 100ALK, 100ALBK, 140AK, 140SK



 **KN6410** Specific engine guard, black  
*25 mm diameter steel tube / we recommend fitting by a qualified mechanic*











CODICE	DESCRIZIONE	PRICE
<b>TRIUMPH ST 1050 SPRINT (05 → 11)</b>		
 <b>KZ726</b>	Specific rear rack for <b>MONOKEY®</b> or <b>MONOLOCK®</b> top-case to be combined with the <b>MONOKEY®</b> KM5, KM7, KM8A, KM8B, KM9A or KM9B plate, or with the <b>MONOLOCK®</b> KM5M or KM6M plate / if combined with KM8A, KM8B, KM9A, KM9B it does not allow the assembly of the stop light kit or the remote control device on the case / maximum load allowed 6 kg	
 <b>BF02K</b>	Specific flange for fitting the tank bags with TANKLOCK system	
<b>TRIUMPH TIGER 1050 (07 → 12)</b>		
 <b>KR225</b>	Specific rear rack for <b>MONOKEY®</b> top-case <b>MONOKEY®</b> plate included / maximum load allowed 6 Kg / it is not compatible with the original side-case holder	
 <b>KL727</b>	Specific pannier holder for <b>MONOKEY®</b> , RETRO FIT side-cases it can be mounted only with the specific rear rack KR225	
 <b>BF02K</b>	Specific flange for fitting the tank bags with TANKLOCK system	
 <b>KD225ST</b>	Specific screen, transparent 50,5 x 49,3 cm (H x W) to be mounted instead of the original screen / 12,5 cm higher than the original	
 <b>KN225</b>	Specific engine guard 25 mm diameter steel tube / we recommend fitting by a qualified mechanic	
<b>TRIUMPH TIGER SPORT 1050 (13 → 18)</b>		
 <b>KR6404</b>	Specific rear rack for <b>MONOKEY®</b> top-case <b>MONOKEY®</b> plate included / it is not compatible with the original side-case holder	
 <b>KLR6404</b>	Specific rapid release side-case holder for <b>MONOKEY®</b> , RETRO FIT cases it can be mounted only with the specific rear rack KR6404	
 <b>BF02K</b>	Specific flange for fitting the tank bags with TANKLOCK system	
 <b>KD225ST</b>	Specific screen, transparent 50,5 x 49,3 cm (H x W) only for version 13 > 15 / to be mounted instead of the original screen / 12,5 cm higher than the original	
 <b>01SKITK</b>	Specific kit to mounting the KS900A Smart Bar	
<b>TRIUMPH SPEED TRIPLE 1050 (08 → 10)</b>		
 <b>BF02K</b>	Specific flange for fitting the tank bags with TANKLOCK system	
<b>TRIUMPH SPEED TRIPLE 1050 (11 → 15)</b>		
 <b>TE6402K</b>	Specific holder for soft side bags or for semi-rigid side bags (RA314)	
 <b>BF02K</b>	Specific flange for fitting the tank bags with TANKLOCK system	
 <b>04SKITK</b>	Specific kit to mounting the KS900A Smart Bar	
<b>TRIUMPH SPEED TRIPLE 1050 (16 → 17)</b>		
 <b>TST6411K</b>	Specific holder for soft side bags	
 <b>BF02K</b>	Specific flange for fitting the tank bags with TANKLOCK system	
 <b>01SKITK</b>	Specific kit to mounting the KS900A Smart Bar	
<b>TRIUMPH SPRINT GT 1050 (10 → 16)</b>		
 <b>BF02K</b>	Specific flange for fitting the tank bags with TANKLOCK system	
<b>TRIUMPH TIGER EXPLORER 1200 (12 → 15)</b>		
 <b>KR6403</b>	Specific rear rack for <b>MONOKEY®</b> top-case <b>MONOKEY®</b> plate included	
<b>KRA6403</b>	Specific rear rack in aluminium for <b>MONOKEY®</b> top-case maximum load allowed 6kg / it does not allow the assembly of the stop light kit or the remote control device on the case	













CODICE	DESCRIZIONE	PREZZO
 <b>KLR6403</b>	Specific rapid release side-case holder for <b>MONOKEY®</b> cases <i>not compatible with the side-cases in aluminium KVE37 K-venture</i>	
 <b>BF02K</b>	Specific flange for fitting the tank bags with TANKLOCK system	
 <b>KN6403</b>	Specific engine guard <i>25 mm diameter steel tube / we recommend fitting by a qualified mechanic / black colour</i>	
<b>VARIOUS ACCESSORIES</b> <b>ES6408K</b>	Specific support in aluminium and stainless steel to widen the surface support area of the original side stand	
<b>01SKITK</b>	Specific kit to mounting the KS900A Smart Bar <i>also compatible with versions XC and XC SE</i>	













TRIUMPH	TIGER EXPLORER 1200 (16 → 17)
 <b>KR6403</b>	Specific rear rack for <b>MONOKEY®</b> top-case <b>MONOKEY®</b> plate included
<b>KRA6403</b>	Specific rear rack in aluminium for <b>MONOKEY®</b> top-case <i>maximum load allowed 6kg / it does not allow the assembly of the stop light kit or the remote control device on the case</i>
 <b>KLR6408</b>	Specific rapid release side-case holder for <b>MONOKEY®</b> cases <i>not compatible with the side-cases in aluminium KVE37 K-venture</i>
 <b>BF02K</b>	Specific flange for fitting the tank bags with TANKLOCK system
<b>VARIOUS ACCESSORIES</b> <b>ES6408K</b>	Specific support in aluminium and stainless steel to widen the surface support area of the original side stand

















TRIUMPH	TIGER 1200 (18) <b>NEW</b>
 <b>KR6403</b>	Specific rear rack for <b>MONOKEY®</b> top-case <b>MONOKEY®</b> plate included
<b>KRA6403</b>	Specific rear rack in aluminium for <b>MONOKEY®</b> top-case <i>maximum load allowed 6kg / it does not allow the assembly of the stop light kit or the remote control device on the case</i>
 <b>KLR6408</b>	Specific rapid release side-case holder for <b>MONOKEY®</b> cases <i>not compatible with the side-cases in aluminium KVE37 K-venture</i>
 <b>BF02K</b>	Specific flange for fitting the tank bags with TANKLOCK system
<b>VARIOUS ACCESSORIES</b> <b>ES6408K</b>	Specific support in aluminium and stainless steel to widen the surface support area of the original side stand













TRIUMPH	BONNEVILLE T120 (16 → 18)
 <b>KR6410</b>	Specific rear black rack for <b>MONOLOCK®</b> or <b>MONOKEY®</b> top-case <i>to be combined with the K636 <b>MONOKEY®</b> plate (sold separately), or with the plate already included in the <b>MONOLOCK®</b> top-cases</i>
 <b>KL6410</b>	Specific pannier holder for <b>MONOKEY®</b> , RETRO FIT side-cases
 <b>TMT6410K</b>	Specific holder for soft side bags or for a pair of CR601U side bags <i>it is not compatible with the specific rear rack KR6410</i>
 <b>100ALK</b>	Grey anodized aluminium universal screen Race Cafe, for naked motorcycles 20,5 x 26,5 cm (H x W) <i>to be combined with the specific AL6410AK fitting kit</i>
<b>100ALBK</b>	Black anodized aluminium universal screen Race Cafe, for naked motorcycles 20,5 x 26,5 cm (H x W) <i>to be combined with the specific AL6410AK fitting kit</i>
<b>140AK</b>	Universal transparent screen 35 x 41cm (H x W) <i>to be combined with the specific AL6410AK fitting kit</i>
<b>140SK</b>	Universal smoked screen 35 x 41 cm (H x W) <i>to be combined with the specific AL6410AK fitting kit</i>
<b>AL6410AK</b>	Specific fitting kit for 100ALK, 100ALBK, 140AK, 140SK
 <b>KN6410</b>	Specific engine guard, black <i>25 mm diameter steel tube / we recommend fitting by a qualified mechanic</i>

















CODICE	DESCRIZIONE	PRICE
<b>YAMAHA</b>		
<b>YAMAHA AEROX R 50 (13 → 18)</b>		
 <b>KR2113</b>	Specific rear rack for <b>MONOLOCK®</b> top-case <i>to be combined with the plate already included in the <b>MONOLOCK®</b> top-case</i>	
 <b>288AK</b>	Specific screen, transparent 56 x 71,5 cm (H x W) <i>to be combined with the specific A2113AK fitting kit</i>	
<b>A2113AK</b> ↘	Specific fitting kit, black for 288AK	
<b>YAMAHA BW'S 50 (05 → 17)</b>		
 <b>KR3560</b>	Specific rear rack for <b>MONOLOCK®</b> top-case <i>it is necessary to remove the original grab handle / to be combined with the plate already included in the <b>MONOLOCK®</b> top-case</i>	
<b>YAMAHA NEO'S 50 (08 → 18)</b>		
 <b>KR366</b>	Specific rear rack for <b>MONOLOCK®</b> top-case <i>to be combined with the plate already included in the <b>MONOLOCK®</b> top-case</i>	
 <b>128AK</b>	Specific screen, transparent 74 x 67 cm (H x W) <i>to be combined with the specific A285AK fitting kit / 8 cm higher than 105AK</i>	
<b>105AK</b>	Specific screen, transparent 66 x 67 cm (H x W) <i>to be combined with the specific A285AK fitting kit / With hand protectors</i>	
<b>A285AK</b>	Specific fitting kit for 105AK and 128AK	
<b>YAMAHA NEO'S 50-100 (97 → 02)</b>		
 <b>KR86</b>	Specific rear rack for <b>MONOLOCK®</b> top-case <i>to be combined with the plate already included in the <b>MONOLOCK®</b> top-case</i>	
<b>YAMAHA DD'ELIGHT 114 (13 → 16)</b>		
 <b>KR2114</b>	Specific rear rack for <b>MONOLOCK®</b> top-case <i>to be combined with the plate already included in the <b>MONOLOCK®</b> top-case</i>	
 <b>2114AK</b>	Specific screen, transparent, 40 x 72 cm (H x W) <i>to be combined with the specific A2114AK fitting kit</i>	
<b>A2114AK</b>	Specific fitting kit for 2114AK	
<b>YAMAHA D'ELIGHT 125 (17 → 18)</b>		
 <b>KR2134</b>	Specific rear rack for <b>MONOLOCK®</b> top-case <i>to be combined with the plate already included in the <b>MONOLOCK®</b> top-case</i>	
 <b>308AK</b>	Specific screen, transparent with serigraphy 52 x 66,5 cm (H x W) <i>to be combined with the specific A2134AK fitting kit</i>	
<b>A2134AK</b>	Specific fitting kit for 308AK	
<b>YAMAHA BW'S 125 (10 → 16)</b>		
 <b>KR372</b>	Specific rear rack for <b>MONOLOCK®</b> top-case <i>to be combined with the plate already included in the <b>MONOLOCK®</b> top-case / you must remove the grab rails, they are replaced by the rack itself</i>	
 <b>288AK</b>	Specific screen, transparent 56 x 71,5 cm (H x W) <i>to be combined with the specific A288AK fitting kit</i>	
<b>A288AK</b>	Specific fitting kit, black for 288AK	
<b>YAMAHA CIGNUS X 125 (04 → 06)</b>		
 <b>KR354</b>	Specific rear rack for <b>MONOLOCK®</b> top-case <i>to be combined with the plate already included in the <b>MONOLOCK®</b> top-case</i>	
 <b>102AK</b>	Specific screen, transparent 66 x 68 cm (H x W) <i>only available if article A280A is already fitted / With hand protectors</i>	
<b>128AK</b>	Specific screen, transparent 74 x 67 cm (H x W) <i>only available if article A280A is already fitted / 8 cm higher than 105AK</i>	

CODICE	DESCRIZIONE	PREZZO
<b>YAMAHA CIGNUS X 125 (07 → 15)</b>		
 <b>KR354</b>	Specific rear rack for <b>MONOLOCK®</b> top-case <i>to be combined with the plate already included in the <b>MONOLOCK®</b> top-case</i>	
 <b>102AK</b>	Specific screen, transparent 66 x 68 cm (H x W) <i>to be combined with the specific A283AK fitting kit</i>	
<b>128AK</b>	Specific screen, transparent 74 x 67 cm (H x W) <i>to be combined with the specific A283AK fitting kit / 8 cm higher than 102AK</i>	
<b>A283AK</b>	Specific fitting kit for 102AK and 128AK	
<b>YAMAHA MAJESTY S 125 (14 → 17)</b>		
 <b>KR2121</b>	Specific rear rack for <b>MONOLOCK®</b> top-case <i>to be combined with the plate already included in the <b>MONOLOCK®</b> top-case or with the <b>MONOLOCK®</b> KM5M or KM6M plate</i>	
 <b>2121DTK</b>	Specific screen, transparent 70,5 x 50 cm (H x W) <i>to be combined with the specific D2121KITK fitting kit</i>	
<b>D2121KITK</b>	Specific fitting kit for 2121DTK	
<b>YAMAHA TRICITY 125-155 (14 → 18)</b>		
 <b>KR2120</b>	Specific rear rack for <b>MONOLOCK®</b> top-case <i>to be combined with the plate already included in the <b>MONOLOCK®</b> top-case or KM6M</i>	
 <b>2120DTK</b>	Specific screen, transparent, 74 x 63 cm (H x W) <i>to be mounted instead of the original screen / to be combined with the specific D2120KITK fitting kit</i>	
<b>D2120KITK</b>	Specific fitting kit for 2120DTK	
<b>VARIOUS ACCESSORIES</b> <b>KTB2120</b>	Specific backrest <i>it cannot be mounted if rack and case are installed</i>	
<b>YAMAHA VITY 125 (10 → 15)</b>		
 <b>288AK</b>	Specific screen, transparent 56 x 71,5 cm (H x W) <i>only available if article A289A is already fitted</i>	
<b>YAMAHA XT 125 R/X (05 → 12)</b>		
 <b>KE3320</b>	Specific rear rack for <b>MONOLOCK®</b> top-case <i>to be combined with the plate already included in the <b>MONOLOCK®</b> top-case</i>	
<b>YAMAHA YBR 125 (10 → 14)</b>		
 <b>KR2104</b>	Specific rear rack for <b>MONOLOCK®</b> top-case <i>to be combined with the plate already included in the <b>MONOLOCK®</b> top-case</i>	
<b>YAMAHA N-MAX 125 (15 → 18)</b>		
 <b>KR2123</b>	Specific rear rack for <b>MONOLOCK®</b> top-case <i>to be combined with the plate already included in the <b>MONOLOCK®</b> top-case</i>	
 <b>2123DTK</b>	Specific screen, transparent 81,5 x 64,5 cm (H x W) <i>to be mounted instead of the original screen / to be combined with the specific D2123KITK fitting kit</i>	
<b>D2123KITK</b>	Specific fitting kit for 2123DTK	
<b>VARIOUS ACCESSORIES</b> <b>KTB2123</b>	Specific backrest <i>it cannot be mounted if rack and case are installed</i>	
<b>YAMAHA MAJESTY 125-150-180 (01 → 11)</b>		
 <b>KR460</b>	Specific rear rack for <b>MONOLOCK®</b> top-case <i>to be combined with the plate already included in the <b>MONOLOCK®</b> top-case</i>	
 <b>130DTK</b>	Specific screen, transparent 69,2 x 68,2 cm (H x W) <i>to be combined with the specific D130KITK fitting kit</i>	
<b>D130KITK</b>	Specific fitting kit for 130DTK	



CODICE	DESCRIZIONE	PRICE
<b>YAMAHA XENTER 125-150 (12 → 18)</b>		
 <b>KR2102</b>	Specific rear rack for <b>MONOLOCK®</b> or <b>MONOKEY®</b> top-case <i>to be combined with the K636 MONOKEY® plate (sold separately), or with the plate already included in the MONOLOCK® top-cases / maximum load allowed 6 kg</i>	
 <b>KD2102ST</b>	Specific screen, transparent 65 x 70 cm (H x W) <i>to be mounted instead of the original screen / 14 cm higher than the original wind-screen</i>	
<b>YAMAHA X-CITY 125-250 (07 → 17)</b>		
 <b>KD439ST</b>	Specific screen, transparent with serigraphy 71 x 77 cm (H x W) <i>to be mounted instead of the original screen / 22 cm higher than the original</i>	
<b>YAMAHA X-MAX 125-250 (05 → 09)</b>		
 <b>KR355</b>	Specific rear rack for <b>MONOKEY®</b> top-case <i>you must puncture the housing behind the saddle in arranged sections / MONOKEY® plate included</i>	
<b>KR3550</b>	Specific rear rack for <b>MONOLOCK®</b> top-case <i>you must puncture the housing behind the saddle in arranged sections / to be combined with the plate already included in the MONOLOCK® top-case</i>	
 <b>KD438ST</b>	Specific screen, transparent 63,5 x 69,5 cm (H x W) <i>to be mounted instead of the original screen / 25,5 cm higher than original</i>	
 <b>KTB49</b>	Specific backrest <i>It cannot be mounted if rack and case are installed</i>	
<b>YAMAHA X-MAX 125-250 (10 → 13)</b>		
 <b>KR370</b>	Specific rear rack for <b>MONOKEY®</b> top-case <i>maximum load allowed 6 kg / MONOKEY® plate included / it is necessary to puncture the housing behind the saddle</i>	
<b>KR3700</b>	Specific rear rack for <b>MONOLOCK®</b> top-case <i>it is necessary to puncture the housing behind the saddle / to be combined with the plate already included in the MONOLOCK® top-case</i>	
 <b>446DTK</b>	Specific screen, transparent 73,5 x 63 cm (H x W) <i>to be combined with the specific D446KITK fitting kit / 30 cm higher than original</i>	
<b>D446KITK</b>	Specific fitting kit for 446DTK	
<b>KD446B</b>	Specific low and sports screen gloss black 37 x 43 cm (H x W) <i>to be mounted instead of the original screen</i>	
 <b>KTB55</b>	Specific backrest <i>It cannot be mounted if rack and case are installed</i>	
<b>YAMAHA X-MAX 125-250 (14 → 17)</b>		
 <b>KR2117</b>	Specific rear rack for <b>MONOKEY®</b> top-case <i>maximum load allowed 6 kg / MONOKEY® plate included</i>	
<b>KR2117M</b>	Specific rear rack for <b>MONOLOCK®</b> top-case <i>to be combined with the plate already included in the MONOLOCK® top-case</i>	
 <b>2111DTK</b>	Specific screen, transparent 73 x 59 cm (H x W) <i>to be combined with the specific D2111KITK fitting kit</i>	
<b>D2111KITK</b>	Specific fitting kit for 2111DTK	
 <b>KTB2111</b>	Specific backrest <i>it cannot be mounted if rack and case are installed</i>	
<b>YAMAHA X-MAX 125 (18) <span style="color: red;">NEW</span></b>		
 <b>KR2136</b>	Specific rear rack for <b>MONOLOCK®</b> or <b>MONOKEY®</b> top-case <i>to be combined with the MONOKEY® KM5, KM7, KM8A, KM8B, KM9A or KM9B plate, or with the MONOLOCK® KM5M or KM6M plate / if combined with KM8A, KM8B, KM9A, KM9B it does not allow the assembly of the stop light kit or the remote control device on the case / maximum load allowed 6 kg</i>	
 <b>KD2136ST</b>	Specific screen, transparent 73,5 x 64 cm (H x W) <i>to be mounted instead of the original screen / 20,5 cm higher than the original</i>	
<b>KD2136S</b>	Specific low sports screen smoked 43,5 x 43,5 cm (H x W) <i>to be mounted instead of the original screen</i>	
<b>KD2138S</b>	Specific screen, smoked 64,5 x 57,5 cm (H x W) <i>to be mounted instead of the original screen / 11,5 cm higher than the original</i>	
 <b>KTB2136</b>	Specific backrest <i>it cannot be mounted with Monorack KR2136</i>	



















CODICE	DESCRIZIONE	PREZZO
<b>YAMAHA MAJESTY 250 (00 → 07)</b>		
 <b>KR44</b>	Specific rear rack for <b>MONOKEY</b> ® top-case <b>MONOKEY</b> ® plate included	
<b>KR44M</b>	Specific rear rack for <b>MONOLOCK</b> ® top-case <b>MONOLOCK</b> ® plate included	
 <b>KD127ST</b>	Specific screen, transparent 80 x 70,7 cm (H x W) <i>to be mounted instead of the original screen / without moulding steel / without air intake</i>	
<b>YAMAHA WR250R 250 (08 → 13)</b>		
 <b>05SKITK</b>	Specific kit to mounting the KS900A Smart Bar	
<b>YAMAHA XC 300 VERSITY (03 → 07)</b>		
 <b>KD432ST</b>	Specific screen, transparent 72 x 75 cm (H x W) <i>to be mounted instead of the original screen / 22 cm higher than the original</i>	
<b>YAMAHA X-MAX 300 (17 → 18)</b>		
 <b>KR2136</b>	Specific rear rack for <b>MONOLOCK</b> ® or <b>MONOKEY</b> ® top-case <i>to be combined with the <b>MONOKEY</b>® KM5, KM7, KM8A, KM8B, KM9A or KM9B plate, or with the <b>MONOLOCK</b>® KM5M or KM6M plate / if combined with KM8A, KM8B, KM9A, KM9B it does not allow the assembly of the stop light kit or the remote control device on the case / maximum load allowed 6 kg</i>	
 <b>KD2136ST</b>	Specific screen, transparent 73,5 x 64 cm (H x W) <i>to be mounted instead of the original screen / 20,5 cm higher than the original</i>	
<b>KD2136S</b>	Specific low sports screen smoked 43,5 x 43,5 cm (H x W) <i>to be mounted instead of the original screen</i>	
<b>KD2138S</b>	Specific screen, smoked 64,5 x 57,5 cm (H x W) <i>to be mounted instead of the original screen / 11,5 cm higher than the original</i>	
 <b>KT B2136</b>	Specific backrest <i>it cannot be mounted with Monorack KR2136</i>	
<b>YAMAHA MT-03 321 (16 → 18)</b>		
 <b>KR2127</b>	Specific rear rack for <b>MONOLOCK</b> ® top-case <i>to be combined with the plate already included in the <b>MONOLOCK</b>® top-case</i>	
 <b>BF05K</b>	Specific flange for fitting the tank bags with TANKLOCK system	
 <b>05SKITK</b>	Specific kit to mounting the KS900A Smart Bar	
<b>YAMAHA MAJESTY 400 (04 → 08)</b>		
 <b>K331</b>	Specific rear rack for <b>MONOKEY</b> ® top-case <b>MONOKEY</b> ® plate included	
<b>K331M</b>	Specific rear rack for <b>MONOLOCK</b> ® top-case <b>MONOLOCK</b> ® plate included	
 <b>KD137ST</b>	Specific screen, transparent 74 x 64 cm (H x W) <i>to be mounted instead of the original screen / 4 cm higher than the original</i>	
<b>YAMAHA MAJESTY 400 (09 → 14)</b>		
 <b>K331</b>	Specific rear rack for <b>MONOKEY</b> ® top-case <b>MONOKEY</b> ® plate included	
<b>K331M</b>	Specific rear rack for <b>MONOLOCK</b> ® top-case <b>MONOLOCK</b> ® plate included	
<b>YAMAHA X-MAX 400 (13 → 16)</b>		
 <b>KR2111</b>	Specific rear rack for <b>MONOKEY</b> ® top-case <i>maximum load allowed 6 kg / <b>MONOKEY</b>® plate included</i>	
<b>KR2111M</b>	Specific rear rack for <b>MONOLOCK</b> ® top-case <i>to be combined with the plate already included in the <b>MONOLOCK</b>® top-case</i>	
 <b>2111DTK</b>	Specific screen, transparent 73 x 59 cm (H x W) <i>to be combined with the specific D2111KITK fitting kit</i>	
<b>D2111KITK</b>	Specific fitting kit for 2111DTK	
 <b>KT B2111</b>	Specific backrest <i>it cannot be mounted if rack and case are installed</i>	













CODICE	DESCRIZIONE	PRICE
<b>YAMAHA X-MAX 400 (18) NEW</b>		
 <b>KR2138</b>	Specific rear rack for <b>MONOKEY</b> ® or <b>MONOKEY</b> ® top-case to be combined with the <b>MONOKEY</b> ® KM5, KM8A, KM8B, KM9A or KM9B plate, or with the <b>MONOLOCK</b> ® KM5M or KM6M plate or with the plate already included in the <b>MONOLOCK</b> ® top-cases / if combined with KM8A, KM8B, KM9A, KM9B it does not allow the assembly of the stop light kit or the remote control device on the case / maximum load allowed 6 kg	
 <b>KD2136ST</b>	Specific screen, transparent 73,5 x 64 cm (H x W) to be mounted instead of the original screen / 20,5 cm higher than the original	
<b>KD2136S</b>	Specific low sports screen smoked 43,5 x 43,5 cm (H x W) to be mounted instead of the original screen	
<b>KD2138S</b>	Specific screen, smoked 64,5 x 57,5 cm (H x W) to be mounted instead of the original screen / 11,5 cm higher than the original	
<b>VARIOUS ACCESSORIES</b> <b>KTB2136</b>	Specific backrest it cannot be mounted with Monorack KR2138	
<b>YAMAHA T-MAX 500 (01 → 07)</b>		
 <b>KR45</b>	Specific rear rack for <b>MONOKEY</b> ® top-case <b>MONOKEY</b> ® plate included / it is necessary to puncture the housing behind the saddle	
 <b>KD128ST</b>	Specific screen, transparent 80,1 x 64,5 cm (H x W) to be mounted instead of the original screen	
<b>KD128B</b>	Specific low and sports screen gloss black 52 x 44,5 cm (H x W) to be mounted instead of the original screen	
<b>VARIOUS ACCESSORIES</b> <b>KTB45</b>	Specific backrest	
<b>KTB51</b>	Specific backrest it cannot be mounted if KR45 is installed	
<b>YAMAHA T-MAX 500 (08 → 11)</b>		
 <b>KR2013</b>	Specific rear rack for <b>MONOKEY</b> ® top-case <b>MONOKEY</b> ® plate included / maximum load allowed 6 Kg / it is necessary to puncture the housing behind the saddle	
<b>KR2013M</b>	Specific rear rack for <b>MONOLOCK</b> ® top-case <b>MONOLOCK</b> ® plate included / it is necessary to puncture the housing behind the saddle	
 <b>TK2013K</b>	Specific holder for soft side bags it is not compatible with the specific rear rack KR2013 / KR2013M	
 <b>KD442ST</b>	Specific screen, transparent 50 x 57 cm (H x W) to be mounted instead of the original screen / 16 cm higher than the original wind-screen	
<b>KD442B</b>	Specific low and sports screen gloss black 59 x 45 cm (H x W) to be mounted instead of the original screen / In case you wish remove the mirrors from their mounts, use the two rubber stoppers to close the holes	
<b>KAF442</b> ↘	Specific Airstream sliding wind-screen transparent. Maximum height 90 cm (12 cm of extension) width 58 cm complete with specific fitting kit / to be mounted instead of the original screen	
<b>VARIOUS ACCESSORIES</b> <b>KTB2013</b>	Specific backrest it cannot be mounted if rack and case are installed	
<b>YAMAHA T-MAX 530 (12 → 16)</b>		
 <b>KR2013</b>	Specific rear rack for <b>MONOKEY</b> ® top-case <b>MONOKEY</b> ® plate included / maximum load allowed 6 Kg / it is necessary to puncture the housing behind the saddle	
<b>KR2013M</b>	Specific rear rack for <b>MONOLOCK</b> ® top-case <b>MONOLOCK</b> ® plate included / it is necessary to puncture the housing behind the saddle	
 <b>TK2013K</b>	Specific holder for soft side bags it is not compatible with the specific rear rack KR2013 / KR2013M	
 <b>KD2013ST</b>	Specific screen, transparent 65 x 61 cm (H x W) to be mounted instead of the original screen	
<b>KD2013B</b>	Specific low and sports screen gloss black 46 x 48 cm (H x W) to be mounted instead of the original screen	
<b>VARIOUS ACCESSORIES</b> <b>KTB2013</b>	Specific backrest it cannot be mounted if rack and case are installed	
<b>YAMAHA T-MAX 530 (17 → 18)</b>		
 <b>KR2133</b>	Specific rear rack for <b>MONOLOCK</b> ® or <b>MONOKEY</b> ® top-case to be combined with the <b>MONOKEY</b> ® KM5, KM7, KM8A, KM8B, KM9A or KM9B plate, or with the <b>MONOLOCK</b> ® KM5M or KM6M plate / if combined with KM8A, KM8B, KM9A, KM9B it does not allow the assembly of the stop light kit or the remote control device on the case / maximum load allowed 6 kg	
 <b>TE2133K</b>	Specific holder for soft side bags or for semi-rigid side bags (RA314) to be mounted only with KR2133	

CODICE	DESCRIZIONE	PREZZO
 <b>KD2133ST</b>	Specific screen, transparent 59,5 x 61 cm (H x W) <i>to be mounted instead of the original screen / 12,5 cm higher than the original</i>	
<b>VARIOUS ACCESSORIES</b> <b>KRM02</b>	Universal spray guard <i>it needs to be paired with the specific mounting kit (RM2133KITK)</i>	
<b>RM2133KITK</b>	Specific kit for spray guard KRM02	
<b>YAMAHA FZS 600 FAZER (98 → 03)</b>		
 <b>K3400</b>	Specific rear rack for <b>MONOKEY®</b> or <b>MONOLOCK®</b> top-case <i>To be combined with the plate <b>MONOKEY®</b> K553N, or with the plate <b>MONOLOCK®</b> MKN</i>	
<b>YAMAHA FZ6/FZ6 600 FAZER (04 → 06)</b>		
 <b>KZ351</b>	Specific rear rack for <b>MONOKEY®</b> or <b>MONOLOCK®</b> top-case <i>to be combined with the <b>MONOKEY®</b> KM5, KM7, KM8A, KM8B, KM9A or KM9B plate, or with the <b>MONOLOCK®</b> KM5M or KM6M plate / if combined with KM8A, KM8B, KM9A, KM9B it does not allow the assembly of the stop light kit or the remote control device on the case</i>	
 <b>KL351</b>	Specific pannier holder for <b>MONOKEY®</b> , RETRO FIT side-cases <i>it can be mounted without the specific rear rack KZ351 using the 351KITK / the indicators must be moved from original position</i>	
<b>KLX351</b>	Specific pannier holder for K33 <b>MONOKEY®</b> SIDE cases <i>it can be mounted only with the specific rear rack KZ351 / you must move the indicators from their original position</i>	
 <b>TK351</b>	Specific holder for soft side bags <i>it can be mounted without the specific rear rack KZ351 using the 351KITK</i>	
 <b>351KITK</b>	Specific kit to install the KL351, KLX351 and TK351 without the specific rear rack	
 <b>BF05K</b>	Specific flange for fitting the tank bags with TANKLOCK system	
 <b>KD136ST</b>	Specific screen, transparent 61 x 53,5 cm (H x W) <i>only for FZ6 fazer / to be mounted instead of the original screen / 12,5 cm higher than the original</i>	
<b>140DK</b>	Specific screen, smoked 35 x 36 cm (H x W) <i>only for FZ6 / to be combined with the specific D140KITK fitting kit</i>	
<b>D140KITK</b>	Specific fitting kit for 140DK <i>only for FZ6</i>	
 <b>KN358</b>	Specific engine guard <i>25 mm diameter steel tube / we recommend fitting by a qualified mechanic / It can be installed also on versions having the original central stand / black colour</i>	
<b>YAMAHA FZ6 S2 / FZ6 600 FAZER S2 (07 → 11)</b>		
 <b>KZ351</b>	Specific rear rack for <b>MONOKEY®</b> or <b>MONOLOCK®</b> top-case <i>to be combined with the <b>MONOKEY®</b> KM5, KM7, KM8A, KM8B, KM9A or KM9B plate, or with the <b>MONOLOCK®</b> KM5M or KM6M plate / if combined with KM8A, KM8B, KM9A, KM9B it does not allow the assembly of the stop light kit or the remote control device on the case</i>	
 <b>KL360</b>	Specific pannier holder for <b>MONOKEY®</b> , RETRO FIT side-cases <i>it can be mounted without the specific rear rack KZ351 using the 351KITK / the indicators must be moved from original position</i>	
<b>KLX360</b>	Specific pannier holder for K33 <b>MONOKEY®</b> SIDE cases <i>it can be mounted without the specific rear rack KZ351 using the 351KITK / you must move the indicators from their original position</i>	
<b>351KITK</b>	Specific kit to install the KL360 and TE351K without the specific rear rack	
 <b>TE351K</b>	Specific holder for soft side bags or for semi-rigid side bags (RA314) <i>it can be mounted without the specific rear rack KZ351 using the 351KITK</i>	
 <b>BF05K</b>	Specific flange for fitting the tank bags with TANKLOCK system	
 <b>440DK</b>	 Specific screen, smoked 57 x 57 cm (H x W) <i>for FZ6 Fazer S2 / to be combined with the specific D440KITK fitting kit / 19 cm higher than the original</i>	
 <b>KN358</b>	Specific engine guard <i>25 mm diameter steel tube / we recommend fitting by a qualified mechanic / It can be installed also on versions having the original central stand / black colour</i>	
<b>VARIOUS ACCESSORIES</b> <b>01SKITK</b>	Specific kit to mounting the KS900A Smart Bar	
<b>YAMAHA XJ 600 DIVERSION (91 → 95)</b>		
 <b>K3250</b>	Specific rear rack for <b>MONOKEY®</b> or <b>MONOLOCK®</b> top-case <i>To be combined with the plate <b>MONOKEY®</b> K553N, or with the plate <b>MONOLOCK®</b> MKN</i>	









CODICE	DESCRIZIONE	PRICE
<b>YAMAHA XJ 600 DIVERSION (96 → 03)</b>		
 <b>K3250</b>	Specific rear rack for <b>MONOKEY®</b> or <b>MONOLOCK®</b> top-case <i>To be combined with the plate <b>MONOKEY®</b> K553N, or with the plate <b>MONOLOCK®</b> MKN</i>	
 <b>KD116S</b>	Specific screen, smoked 46 x 33,5 cm (H x W) <i>to be mounted instead of the original screen</i>	
<b>YAMAHA XJ 600 DIVERSION N (96 → 99)</b>		
 <b>K3250</b>	Specific rear rack for <b>MONOKEY®</b> or <b>MONOLOCK®</b> top-case <i>To be combined with the plate <b>MONOKEY®</b> K553N, or with the plate <b>MONOLOCK®</b> MKN</i>	
<b>YAMAHA XJ6 (09 → 12) / XJ6 DIVERSION / XJ6 DIVERSION F 600 (09 → 13)</b>		
 <b>KZ364</b>	Specific rear rack for <b>MONOKEY®</b> or <b>MONOLOCK®</b> top-case <i>to be combined with the <b>MONOKEY®</b> KM5, KM7, KM8A, KM8B, KM9A or KM9B plate, or with the <b>MONOLOCK®</b> KM5M or KM6M plate / if combined with KM8A, KM8B, KM9A, KM9B it does not allow the assembly of the stop light kit or the remote control device on the case</i>	
 <b>KLXR364</b>	Specific rapid release side-case holder for K33 <b>MONOKEY®</b> <b>SIDE</b> cases	
 <b>TE2110K</b>	Specific holder for soft side bags or for semi-rigid side bags (RA314) <i>it can be mounted without the specific rear rack KZ364 using the 2110KITK</i>	
<b>2110KITK</b>	Specific kit to install the TE2110K without the specific rear rack KZ364	
 <b>BF05K</b>	Specific flange for fitting the tank bags with TANKLOCK system	
 <b>KD444S</b>	Specific screen, smoked 42.5 x 38 cm (H x W) <i>only for XJ6 Diversion / to be mounted instead of the original screen / 10 cm higher than the original</i>	
<b>VARIOUS ACCESSORIES</b> <b>05SKITK</b>	Specific kit to mounting the KS900A Smart Bar	
<b>YAMAHA XJ6 600 (13 → 15)</b>		
 <b>KZ364</b>	Specific rear rack for <b>MONOKEY®</b> or <b>MONOLOCK®</b> top-case <i>to be combined with the <b>MONOKEY®</b> KM5, KM7, KM8A, KM8B, KM9A or KM9B plate, or with the <b>MONOLOCK®</b> KM5M or KM6M plate / if combined with KM8A, KM8B, KM9A, KM9B it does not allow the assembly of the stop light kit or the remote control device on the case</i>	
 <b>KLXR364</b>	Specific rapid release side-case holder for K33 <b>MONOKEY®</b> <b>SIDE</b> cases	
 <b>BF05K</b>	Specific flange for fitting the tank bags with TANKLOCK system	
 <b>TE2110K</b>	Specific holder for soft side bags or for semi-rigid side bags (RA314) <i>it can be mounted without the specific rear rack KZ364 using the 2110KITK</i>	
<b>2110KITK</b>	Specific kit to install the TE2110K without the specific rear rack KZ364	
<b>VARIOUS ACCESSORIES</b> <b>05SKITK</b>	Specific kit to mounting the KS900A Smart Bar	
<b>YAMAHA MT-03 660 (06 → 14)</b>		
 <b>KZ356</b>	Specific rear rack for <b>MONOKEY®</b> or <b>MONOLOCK®</b> top-case <i>to be combined with the <b>MONOKEY®</b> KM5, KM7, KM8A, KM8B, KM9A or KM9B plate, or with the <b>MONOLOCK®</b> KM5M or KM6M plate / if combined with KM8A, KM8B, KM9A, KM9B it does not allow the assembly of the stop light kit or the remote control device on the case / maximum load allowed 6 Kg / with integrated passenger grabrails</i>	
 <b>TK129</b>	Specific holder for soft side bags	
 <b>BF05K</b>	Specific flange for fitting the tank bags with TANKLOCK system	
 <b>245AK</b>	Universal screen, smoked 33,5 x 29 cm (H x W) <i>to be combined with the specific A281AK fitting kit</i>	
<b>245NK</b>	Universal screen, black 33,5 x 29 cm (H x W) <i>to be combined with the specific A281AK fitting kit / The inside is painted in matt colour to prevent the front light from reflecting</i>	
<b>A281AK</b>	Specific fitting kit for 245AK, 245NK, 246_ _ _	
<b>YAMAHA YZF 600 THUNDER CAT (96 → 02)</b>		
 <b>K3380</b>	Specific rear rack for <b>MONOKEY®</b> or <b>MONOLOCK®</b> top-case <i>To be combined with the plate <b>MONOKEY®</b> K553N, or with the plate <b>MONOLOCK®</b> MKN</i>	

CODICE	DESCRIZIONE	PREZZO
<b>YAMAHA YZF 600 R6 (06 → 07)</b>		
 <b>BF05K</b>	Specific flange for fitting the tank bags with TANKLOCK system	
<b>YAMAHA XVS 650 DRAG STAR (97 → 02)</b>		
 <b>A35NK</b>	Universal screen, 54,9 x 46,8 cm (H x W) <i>High and shaded bottom version</i>	
<b>23A</b>	Universal screen, 38,8 x 41 cm (H x W)	
<b>AS100A2K</b>	Specific fitting kit for 23A and A35NK	
<b>YAMAHA XVS 650A DRAG STAR CLASSIC (98 → 07)</b>		
 <b>A39K</b>	Universal screen, transparent 51,7 x 57,3 cm (H x W) <i>to be combined with the specific AS102A2 fitting kit/ High version</i>	
<b>YAMAHA XT 660 R / XT 660 X (04 → 06)</b>		
 <b>KR353M</b>	Specific rear rack for <b>MONOLOCK</b> ® top-case <b>MONOLOCK</b> ® plate included	
 <b>KD433S</b>	Specific screen, smoked 37 x 36,5 cm (H x W) <i>to be mounted instead of the original screen</i>	
<b>YAMAHA XT 660 R/ XT 660 X (07 → 16)</b>		
 <b>KR365M</b>	Specific rear rack for <b>MONOLOCK</b> ® top-case <b>MONOLOCK</b> ® plate included	
 <b>KD433S</b>	Specific screen, smoked 37 x 36,5 cm (H x W) <i>only for XT 660 R version / to be mounted instead of the original screen</i>	
<b>YAMAHA XT 660 Z TENERÉ (08 → 16)</b>		
 <b>K333</b>	Specific rear rack for <b>MONOKEY</b> ® top-case <b>MONOKEY</b> ® plate included	
<b>K333M</b>	Specific rear rack for <b>MONOLOCK</b> ® top-case <b>MONOLOCK</b> ® plate included	
 <b>KL363</b>	Specific pannier holder for <b>MONOKEY</b> ®, RETRO FIT side-cases	
 <b>KD443ST</b>	Specific screen, transparent 40 x 42 cm (H x W) <i>to be mounted instead of the original screen / 10 cm higher than the original</i>	
 <b>KN2105</b>	Specific engine guard <i>25 mm diameter steel tube / we recommend fitting by a qualified mechanic / black colour</i>	
<b>RP2105K</b>	Oil carter protector in Aluminium	
<b>YAMAHA MT-07 700 (14 → 17)</b>		
 <b>KZ2118</b>	Specific rear rack for <b>MONOKEY</b> ® or <b>MONOLOCK</b> ® top-case <i>to be combined with the <b>MONOKEY</b>® KM5, KM7, KM8A, KM8B, KM9A or KM9B plate, or with the <b>MONOLOCK</b>® KM5M or KM6M plate / if combined with KM8A, KM8B, KM9A, KM9B it does not allow the assembly of the stop light kit or the remote control device on the case / you have to puncture the housing under the tail</i>	
 <b>KLX2118</b>	Specific pannier holder for K33 <b>MONOKEY</b> ® <b>SIDE</b> cases <i>it can be mounted only with the specific rear rack KZ2118</i>	
 <b>BF21K</b>	Specific flange for fitting the tank bags with TANKLOCK system	
 <b>TE2118K</b>	Specific holder for soft side bags or for semi-rigid side bags (RA314) <i>it can be mounted without the specific rear rack KZ2118 using the 2118KITK</i>	
 <b>2118KITK</b>	Specific kit to install the TE2118K without the specific rear rack KZ2118	
 <b>KA2118</b>	Specific screen, black 28,5 x 36 cm (H x W) <i>Complete with fitting kit</i>	
 <b>KHP2115</b>	Specific hands protector in ABS	

CODICE	DESCRIZIONE	PRICE
<b>YAMAHA MT-07 (18) <span style="background-color: orange; color: white; padding: 2px;">NEW</span></b>		
 <b>KZ2140</b>	Specific rear rack for <b>MONOKEY®</b> or <b>MONOLOCK®</b> top-case <i>to be combined with the <b>MONOKEY®</b> KM5, KM7, KM8A, KM8B, KM9A or KM9B plate, or with the <b>MONOLOCK®</b> KM5M or KM6M plate / if combined with KM8A, KM8B, KM9A, KM9B it does not allow the assembly of the stop light kit or the remote control device on the case / maximum load allowed 6 kg</i>	
 <b>KLX2140</b>	Specific pannier holder for K33 <b>MONOKEY®</b> <b>SIDE</b> cases	
 <b>TE2140K</b>	Specific holder for soft side bags or for semi-rigid side bags (RA314) <i>it can be mounted without the specific rear rack KZ2140 using the 2140KITK</i>	
<b>2140KITK</b>	Specific kit to install the TE2140K without the specific rear rack KZ2140	
 <b>BF36K</b>	Specific flange for fitting the tank bags with TANKLOCK system <i>only compatible with bags of up to 5 ltr in capacity</i>	
 <b>KA2140</b>	Specific screen, smoked 28 x 36,5 cm (H x W) <i>complete with specific fitting kit</i>	
<b>KA2140BL</b>	Specific BLUE LINE screen 28 x 36,5 cm (H x W) <i>complete with specific fitting kit / when illuminated by vehicle headlights in low light conditions, the edge glows blue in colour</i>	
 <b>KN2130</b>	Specific engine guard, black <i>25 mm diameter steel tube / we recommend fitting by a qualified mechanic</i>	
<b>KPR2126</b>	Stainless steel specific radiator guard black painted	
<b>VARIOUS ACCESSORIES</b> <b>KHP2115</b>	Specific hands protector in ABS	
<b>YAMAHA MT-07 TRACER (16 → 18)</b>		
 <b>KZ2130</b>	Specific rear rack for <b>MONOKEY®</b> or <b>MONOLOCK®</b> top-case <i>to be combined with the <b>MONOKEY®</b> KM5, KM7, KM8A, KM8B, KM9A or KM9B plate, or with the <b>MONOLOCK®</b> KM5M or KM6M plate / if combined with KM8A, KM8B, KM9A, KM9B it does not allow the assembly of the stop light kit or the remote control device on the case</i>	
 <b>KLR2130</b>	Specific rapid release side-case holder for <b>MONOKEY®</b> , RETRO FIT cases	
<b>KLXR2130</b>	Specific rapid release side-case holder for K33 <b>MONOKEY®</b> <b>SIDE</b> cases	
 <b>TST2130K</b>	Specific holder for soft side bags	
 <b>BF05K</b>	Specific flange for fitting the tank bags with TANKLOCK system	
 <b>KD2130S</b>	Specific screen, smoked 51 x 41 cm (H x W) <i>to be mounted instead of the original screen / 12 cm higher than the original</i>	
<b>KD2130ST</b>	Specific screen, transparent 56 x 41 cm (H x W) <i>to be mounted instead of the original screen / 17 cm higher than the original</i>	
<b>KD2130BO</b>	Specific low and sports screen matt black 32,5 x 33 cm (H x W) <i>to be mounted instead of the original screen</i>	
 <b>KN2130</b>	Specific engine guard, black <i>25 mm diameter steel tube / we recommend fitting by a qualified mechanic</i>	
<b>KNH2130</b>	Specific engine guard, black <i>25 mm diameter steel tube / we recommend fitting by a qualified mechanic / it protects the upper part of the radiators / it must be mounted with KN2130</i>	
<b>KPR2130</b>	Stainless steel specific radiator guard black painted	
<b>VARIOUS ACCESSORIES</b> <b>KRM01</b>	Universal spray guard <i>It needs to be paired with the specific mounting kit (RM2130KITK)</i>	
<b>KRM02</b>	Universal spray guard <i>It needs to be paired with the specific mounting kit (RM2130KITK)</i>	
<b>RM2130KITK</b>	Specific kit for spray guard KRM01, KRM02	
<b>LS2130K</b>	Specific fitting kit to mount KS310 or KS322 spotlights where specific engine guard is not present	
<b>EH2130K</b>	Extension in ABS for original hands protector	
<b>ES2130K</b>	Specific support in aluminium and stainless steel to widen the surface support area of the original side stand	
<b>KFB2130</b>	Fairing upper bracket to be mounted behind the windshield to install KS920M, KS920L and GPS-Smartphone holder <i>Compatible with the original windshield and the windshield KD2130ST, KD2130S, KD2130BO / For KS920M, KS920L, KS952B, KS953B, KS954B, KS955B, KS956B, KS957B</i>	
<b>06SKITK</b>	Specific kit to mounting the KS900A Smart Bar	

CODICE	DESCRIZIONE	PREZZO
--------	-------------	--------

### YAMAHA XSR 700 (16 → 18)







 <b>KR2126</b>	Specific rear black rack for <b>MONOLOCK®</b> or <b>MONOKEY®</b> top-case <i>to be combined with the K636 <b>MONOKEY®</b> plate (sold separately), or with the plate already included in the <b>MONOLOCK®</b> top-cases</i>
 <b>KL2126</b>	Specific pannier holder for <b>MONOKEY®</b> side-cases <i>you can only mount cases <b>MONOKEY®</b> K22</i>
 <b>TMT2126K</b>	Specific holder for soft side bags or for a pair of CR601U side bags
 <b>BF24K</b>	Specific flange for fitting the tank bags with TANKLOCK system <i>Not compatible with bags that have a curved base (RA311, RA311R)</i>
 <b>100ALK</b>	Grey anodized aluminium universal screen Race Cafe, for naked motorcycles 20,5 x 26,5 cm (H x W) <i>to be combined with the specific AL2126AK fitting kit</i>
<b>100ALBK</b>	Black anodized aluminium universal screen Race Cafe, for naked motorcycles 20,5 x 26,5 cm (H x W) <i>to be combined with the specific AL2126AK fitting kit</i>
<b>140AK</b>	Universal transparent screen 35 x 41cm (H x W) <i>to be combined with the specific AL2126AK fitting kit</i>
<b>140SK</b>	Universal smoked screen 35 x 41 cm (H x W) <i>to be combined with the specific AL2126AK fitting kit</i>
<b>AL2126AK</b>	Specific fitting kit for 100ALK, 100ALBK, 140AK, 140SK
 <b>KPR2126</b>	Stainless steel specific radiator guard black painted
 <b>KHP2115</b>	Specific hands protector in ABS

VARIOUS ACCESSORIES



### YAMAHA XV 750 VIRAGO (89 → 98)

<b>A35NK</b>	specific screen, transparent 54,9 x 46,8 cm (H x W) <i>compatible from '92 to '98 / high and shaded bottom version</i>
<b>23A</b>	Specific screen, transparent 38,8 x 41 cm (H x W) <i>compatible from '92 to '98 / low, transparent version</i>
 <b>AS100A2K</b>	Specific fitting kit for 23A and A35NK

### YAMAHA FZ8 / FAZER 8 800 (10 → 15)













 <b>KZ366</b>	Specific rear rack for <b>MONOKEY®</b> or <b>MONOLOCK®</b> top-case <i>to be combined with the <b>MONOKEY®</b> KM5, KM7, KM8A, KM8B, KM9A or KM9B plate, or with the <b>MONOLOCK®</b> KM5M or KM6M plate / if combined with KM8A, KM8B, KM9A, KM9B it does not allow the assembly of the stop light kit or the remote control device on the case / maximum load allowed 6 kg</i>
 <b>KLXR366</b>	Specific rapid release side-case holder for K33 <b>MONOKEY® SIDE</b> cases <i>it can be mounted without the specific rear rack KZ366 using the 366KITK / you must move the indicators from their original position</i>
<b>366KITK</b>	Specific kit to install the KLXR366 and TE366K without the specific rear rack
 <b>TE366K</b>	Specific holder for soft side bags or for semi-rigid side bags (RA314) <i>it can be mounted without the specific rear rack KZ366 using the 366KITK</i>
 <b>BF05K</b>	Specific flange for fitting the tank bags with TANKLOCK system
 <b>KD448S</b>	Specific screen, smoked 55,5 x 55,5 cm (H x W) <i>only for Fazer 8 / to be mounted instead of the original screen / 19 cm higher than original</i>
 <b>05SKITK</b>	Specific kit to mounting the KS900A Smart Bar

### YAMAHA TDM 850 (96 → 01)

 <b>K3360</b>	Specific rear rack for <b>MONOKEY®</b> or <b>MONOLOCK®</b> top-case <i>To be combined with the plate <b>MONOKEY®</b> K553N, or with the plate <b>MONOLOCK®</b> MKN</i>
 <b>KD116S</b>	Specific screen, smoked 46 x 33,5 cm (H x W) <i>to be mounted instead of the original screen</i>

### YAMAHA MT-09 850 (13 → 16)





 <b>KZ2115</b>	Specific rear rack for <b>MONOKEY®</b> or <b>MONOLOCK®</b> top-case <i>to be combined with the <b>MONOKEY®</b> KM5, KM7, KM8A, KM8B, KM9A or KM9B plate, or with the <b>MONOLOCK®</b> KM5M or KM6M plate / if combined with KM8A, KM8B, KM9A, KM9B it does not allow the assembly of the stop light kit or the remote control device on the case / maximum load allowed 6 kg</i>
 <b>TE2115K</b>	Specific holder for soft side bags or for semi-rigid side bags (RA314) <i>it can be mounted without the specific rear rack KZ2115 using the 2115KITK</i>

CODICE	DESCRIZIONE	PRICE
<b>2115KITK</b>	Specific kit to install the TE2115K without the specific rear rack KZ2115	
 <b>BF05K</b>	Specific flange for fitting the tank bags with TANKLOCK system	
 <b>KA2115</b>	Specific screen, smoked 28.5 x 36 cm (H x W) <i>complete with fitting kit</i>	
<b>VARIOUS ACCESSORIES</b> <b>KHP2115</b>	Specific hands protector in ABS	
<b>01SKITK</b>	Specific kit to mounting the KS900A Smart Bar	
<b>YAMAHA MT-09 (17 → 18)</b>		
 <b>KZ2132</b>	Specific rear rack for <b>MONOKEY®</b> or <b>MONOLOCK®</b> top-case <i>to be combined with the MONOKEY® KM5, KM7, KM8A, KM8B, KM9A or KM9B plate, or with the MONOLOCK® KM5M or KM6M plate / if combined with KM8A, KM8B, KM9A, KM9B it does not allow the assembly of the stop light kit or the remote control device on the case / maximum load allowed 6 kg / in order to install it you must reposition the indicators from their original position</i>	
 <b>TST2132K</b>	Specific holder for soft side bags <i>it can be mounted without the specific rear rack KZ2132 using the IN2132KITK / you must move the indicators from their original position</i>	
<b>IN2132KITK</b>	Specific kit to move the indicators from their original position and to enable the installation of TST2132	
 <b>BF05K</b>	Specific flange for fitting the tank bags with TANKLOCK system	
 <b>KA2132</b>	Specific screen, smoked 28 x 36,5 cm (H x W) <i>complete with specific fitting kit</i>	
<b>KA2132BL</b>	Specific screen, BLUE LINE 28 x 36,5 cm (H x W) <i>complete with specific fitting kit / when illuminated by vehicle headlights in low light conditions, the edge glows blue in colour</i>	
 <b>KN2132</b>	Specific engine guard, black <i>25 mm diameter steel tube / we recommend fitting by a qualified mechanic</i>	
<b>KPR2132</b>	Stainless steel specific radiator guard black painted	
<b>VARIOUS ACCESSORIES</b> <b>KHP2115</b>	Specific hands protector in ABS	
<b>01SKITK</b>	Specific kit to mounting the KS900A Smart Bar	
<b>YAMAHA MT-09 850 TRACER (15 → 17)</b>		
 <b>KR2122</b>	Specific rear rack for <b>MONOLOCK®</b> or <b>MONOKEY®</b> top-case <i>to be combined with the MONOKEY® KM5, KM7, KM8A, KM8B, KM9A or KM9B plate, or with the MONOLOCK® KM5M or KM6M plate / if combined with KM8A, KM8B, KM9A, KM9B it does not allow the assembly of the stop light kit or the remote control device on the case</i>	
 <b>KLR2122</b>	Specific rapid release side-case holder for <b>MONOKEY®</b> , RETRO FIT cases	
<b>KLXR2122</b>	Specific rapid release side-case holder for K33 <b>MONOKEY® SIDE</b> cases	
 <b>TE2122K</b>	Specific holder for soft side bags or for semi-rigid side bags (RA314)	
 <b>BF23K</b>	Specific flange for fitting the tank bags with TANKLOCK system	
 <b>2122DTK</b>	Specific screen, transparent, 69 x 50 cm (H x W) <i>to be combined with the specific D2122KITK fitting kit</i>	
<b>D2122KITK</b>	Specific fitting kit for 2122DTK	
<b>KD2122S</b>	Specific screen, smoked 48 x 42 cm (H x W) <i>to be mounted instead of the original screen</i>	
 <b>KN2122</b>	Specific engine guard, black <i>25 mm diameter steel tube / we recommend fitting by a qualified mechanic</i>	
<b>KPR2132</b>	Stainless steel specific radiator guard black painted	
<b>VARIOUS ACCESSORIES</b> <b>KRM01</b>	Universal spray guard <i>It needs to be paired with the specific mounting kit (RM2122KITK)</i>	
<b>KRM02</b>	Universal spray guard <i>It needs to be paired with the specific mounting kit (RM2122KITK)</i>	
<b>RM2122KITK</b>	Specific kit for spray guard KRM01, KRM02	

CODICE	DESCRIZIONE	PREZZO
--------	-------------	--------

<b>LS2122K</b>	Specific fitting kit to mount KS310 or KS322 spotlights where specific engine guard is not present	
<b>EH2122K</b>	Plexiglass extension for original hands protector, smoked	
<b>ES2122K</b>	Specific support in aluminium and stainless steel to widen the surface support area of the original side stand	
<b>KFB2122</b>	Fairing upper bracket to be mounted behind the windshield to install KS920M, KS920L and GPS-Smartphone holder <i>Compatible with the original windshield and the windshield KD2122S, 2122DTK / For KS920M, KS920L, KS952B, KS953B, KS954B, KS955B, KS956B</i>	
<b>04SKITK</b>	Specific kit to mounting the KS900A Smart Bar	

### YAMAHA TDM 900 (02 → 14)







 <b>K3470</b>	Specific rear rack for <b>MONOKEY</b> ® or <b>MONOLOCK</b> ® top-case <i>To be combined with the plate <b>MONOKEY</b>® K553N, or with the plate <b>MONOLOCK</b>® MKN/ maximum load allowed 6 kg</i>
<b>KR347</b>	Specific rear rack for <b>MONOLOCK</b> ® or <b>MONOKEY</b> ® top-case <i>to be combined with the K636 <b>MONOKEY</b>® plate (sold separately), or with the plate already included in the <b>MONOLOCK</b>® top-cases / maximum load allowed 5 kg</i>
 <b>KL347</b>	Specific pannier holder for <b>MONOKEY</b> ®, RETRO FIT side-cases
<b>KLX347</b>	Specific pannier holder for K33 <b>MONOKEY</b> ® <b>SIDE</b> cases <i>you must move the indicators from their original position</i>
 <b>BF05K</b>	Specific flange for fitting the tank bags with TANKLOCK system
 <b>KD132S</b>	Specific screen, smoked 41 x 32,5 cm (H x W) <i>to be mounted instead of the original screen / with spoiler</i>
 <b>KN34</b>	Specific engine guard <i>25 mm diameter steel tube / we recommend fitting by a qualified mechanic / black colour</i>

<b>VARIOUS ACCESSORIES</b> <b>05SKITK</b>	Specific kit to mounting the KS900A Smart Bar
---	---

### YAMAHA XJ 900 DIVERSION (94 → 05)









 <b>K3310</b>	Specific rear rack for <b>MONOKEY</b> ® or <b>MONOLOCK</b> ® top-case <i>To be combined with the plate <b>MONOKEY</b>® K553N, or with the plate <b>MONOLOCK</b>® MKN</i>
--	---

### YAMAHA XSR 900 (16 → 18) **NEW**

 <b>KZ2115</b>	Specific rear rack for <b>MONOKEY</b> ® or <b>MONOLOCK</b> ® top-case <i>to be combined with the <b>MONOKEY</b>® KM5, KM7, KM8A, KM8B, KM9A or KM9B plate, or with the <b>MONOLOCK</b>® KM5M or KM6M plate / if combined with KM8A, KM8B, KM9A, KM9B it does not allow the assembly of the stop light kit or the remote control device on the case / maximum load allowed 6 kg</i>
 <b>KL2128</b>	Specific pannier holder for <b>MONOKEY</b> ®, RETRO FIT side-cases <i>you must move the indicators from their original position</i>
 <b>TMT2128K</b>	Specific holder for soft side bags or for a pair of CR601U side bags <i>it is not compatible with the specific rear rack KZ2115</i>
 <b>BF05K</b>	Specific flange for fitting the tank bags with TANKLOCK system <i>only for small TANKLOCK bags; the bag is not centered on the tank because the flange is not in the center of the tank</i>
 <b>100ALK</b>	Grey anodized aluminium universal screen Race Cafe, for naked motorcycles 20,5 x 26,5 cm (H x W) <i>to be combined with the specific AL2128AK fitting kit</i>
<b>100ALBK</b>	Black anodized aluminium universal screen Race Cafe, for naked motorcycles 20,5 x 26,5 cm (H x W) <i>to be combined with the specific AL2128AK fitting kit</i>
<b>140AK</b>	Universal transparent screen 35 x 41cm (H x W) <i>to be combined with the specific AL2128AK fitting kit</i>
<b>140SK</b>	Universal smoked screen 35 x 41 cm (H x W) <i>to be combined with the specific AL2128AK fitting kit</i>
<b>AL2128AK</b>	Specific fitting kit for 100ALK, 100ALBK, 140AK, 140SK
 <b>KN2128</b>	Specific engine guard, black <i>25 mm diameter steel tube / we recommend fitting by a qualified mechanic</i>
<b>KPR2128</b>	Stainless steel specific radiator guard black painted

<b>VARIOUS ACCESSORIES</b> <b>ES2122K</b>	Specific support in aluminium and stainless steel to widen the surface support area of the original side stand
---	--

<b>01SKITK</b>	Specific kit to mounting the KS900A Smart Bar
----------------	---

CODICE	DESCRIZIONE	PRICE
<b>YAMAHA</b>		
<b>TRACER 900 / TRACER 900 GT (18) <span style="background-color: orange; color: white; padding: 2px;">NEW</span></b>		
 <b>KR2139</b>	Specific rear rack for <b>MONOLOCK®</b> or <b>MONOKEY®</b> top-case to be combined with the <b>MONOKEY®</b> KM5, KM8A, KM8B, KM9A or KM9B plate, or with the <b>MONOLOCK®</b> KM5M or KM6M plate or with the plate already included in the <b>MONOLOCK®</b> top-cases / if combined with KM8A, KM8B, KM9A, KM9B it does not allow the assembly of the stop light kit or the remote control device on the case	
 <b>KLR2139</b>	Specific rapid release side-case holder for <b>MONOKEY®</b> , RETRO FIT cases it can be mounted without the specific rear rack KR2139 using the 2139KITK	
<b>KTL2139KIT</b>	Specific kit to install the KS250 Tool Box on KLR2139 to be combined with KS250 and KLR2139 / it can be mounted on either the right-hand side or left-hand side of the motorcycle	
<b>KLXR2139</b>	Specific rapid release side-case holder for K33 <b>MONOKEY® SIDE</b> cases it can be mounted without the specific rear rack KR2139 using the 2139KITK	
<b>2139KITK</b>	Specific kit to install the KLR2139, KLXR2139 without the specific rear rack KR2139	
 <b>BF23K</b>	Specific flange for fitting the tank bags with TANKLOCK system	
 <b>KD2139S</b>	Specific screen, smoked 55 x 46,5 cm (H x W) to be mounted instead of the original screen / 6 cm higher than the original	
<b>2139DTK</b>	Specific screen, transparent 69,5 x 48 cm (H x W) to be combined with the specific D2139KITK fitting kit / 20,5 cm higher than the original	
<b>D2139KITK</b>	Specific fitting kit for 2139DTK	
 <b>KN2139</b>	Specific engine guard, black 25 mm diameter steel tube / we recommend fitting by a qualified mechanic	
<b>RP2139K</b>	Oil carter protector in Aluminium	
<b>KPR2139</b>	Stainless steel specific radiator guard black painted	
<b>VARIOUS ACCESSORIES</b> <b>KRM02</b>	Universal spray guard it needs to be paired with the specific mounting kit (RM2139KITK)	
<b>RM2139KITK</b>	Specific kit for spray guard KRM02	
<b>ES2122K</b>	Specific support in aluminium and stainless steel to widen the surface support area of the original side stand	
<b>LS2139K</b>	Specific fitting kit to mount KS310 or KS322 spotlights where specific engine guard is not present	
<b>EH2139K</b>	Plexiglass extension for original hands protector, smoked	
<b>04SKITK</b>	Specific kit to mounting the KS900A Smart Bar	
<b>YAMAHA</b>		
<b>NIKEN 900 (19) <span style="background-color: orange; color: white; padding: 2px;">NEW</span></b>		
 <b>BF05K</b>	Specific flange for fitting the tank bags with TANKLOCK system	
<b>VARIOUS ACCESSORIES</b> <b>ES2122K</b>	Specific support in aluminium and stainless steel to widen the surface support area of the original side stand	
<b>YAMAHA</b>		
<b>FZ1 1000 (06 → 15)</b>		
 <b>KZ365</b>	Specific rear rack for <b>MONOLOCK®</b> top-case we recommend mounting smaller cases <b>MONOLOCK®</b> in conjunction with KM5M or KM6M plates / it requires fitment of cases up to 35 ltr / maximum load allowed 6 kg / You have to puncture the housing under the tail in arranged sections	
 <b>KLX359</b>	Specific pannier holder for K33 <b>MONOKEY® SIDE</b> cases it can be mounted without the specific rear rack KZ359 using the 365KITK / you must move the indicators from their original position	
<b>KLXR359</b>	Specific rapid release side-case holder for K33 <b>MONOKEY® SIDE</b> cases it can be mounted without the specific rear rack KZ359 using the 365KITK / you must move the indicators from their original position	
<b>365KITK</b>	Specific kit to install the KLX and the KLXR without the specific rear rack	
 <b>TK271</b>	Specific holder for soft side bags it is not compatible with the specific rear rack KZ365	
 <b>BF05K</b>	Specific flange for fitting the tank bags with TANKLOCK system	
<b>VARIOUS ACCESSORIES</b> <b>05SKITK</b>	Specific kit to mounting the KS900A Smart Bar	

CODICE	DESCRIZIONE	PREZZO
--------	-------------	--------

**YAMAHA FZS 1000 FAZER (01 → 02)**

 **KZ348** Specific rear rack for **MONOKEY®** or **MONOLOCK®** top-case to be combined with the **MONOKEY®** KM5, KM7, KM8A, KM8B, KM9A or KM9B plate, or with the **MONOLOCK®** KM5M or KM6M plate / if combined with KM8A, KM8B, KM9A, KM9B it does not allow the assembly of the stop light kit or the remote control device on the case

**YAMAHA FZS 1000 FAZER (03 → 05)**

 **KZ348** Specific rear rack for **MONOKEY®** or **MONOLOCK®** top-case to be combined with the **MONOKEY®** KM5, KM7, KM8A, KM8B, KM9A or KM9B plate, or with the **MONOLOCK®** KM5M or KM6M plate / if combined with KM8A, KM8B, KM9A, KM9B it does not allow the assembly of the stop light kit or the remote control device on the case

 **KL349** Specific pannier holder for **MONOKEY®**, RETRO FIT side-cases it can be mounted only with the specific rear rack KZ348

**YAMAHA FZ1 1000 FAZER (06 → 15)**

 **KZ359** Specific rear rack for **MONOLOCK®** top-case we recommend mounting smaller cases **MONOLOCK®** in conjunction with KM5M or KM6M plates / It requires fitment of cases up to 37 ltr / maximum load allowed 6 kg / You have to puncture the housing under the tail in arranged sections

 **KLX359** Specific pannier holder for K33 **MONOKEY®** SIDE cases it can be mounted without the specific rear rack KZ359 using the PLX359KIT / you must move the indicators from their original position

**KLXR359** Specific rapid release side-case holder for K33 **MONOKEY®** SIDE cases it can be mounted without the specific rear rack KZ359 using the PLX359KIT / you must move the indicators from their original position

 **BF05K** Specific flange for fitting the tank bags with TANKLOCK system

 **KD437S** Specific screen, smoked 52 x 44 cm (H x W) to be mounted instead of the original screen / 14 cm higher than the original

**YAMAHA YZF R1 1000 (09→12)**

 **BF05K** Specific flange for fitting the tank bags with TANKLOCK system

 **KD2106S** Specific screen, smoked 38 x 32 cm (H x W) to be mounted instead of the original screen

**YAMAHA MT-10 (16 → 18)**

 **KR2129** Specific rear rack for **MONOLOCK®** or **MONOKEY®** top-case to be combined with the **MONOKEY®** KM5, KM7, KM8A, KM8B, KM9A or KM9B plate, or with the **MONOLOCK®** KM5M or KM6M plate / if combined with KM8A, KM8B, KM9A, KM9B it does not allow the assembly of the stop light kit or the remote control device on the case / maximum load allowed 6 kg

 **KLXR2129** Specific rapid release side-case holder for K33 **MONOKEY®** SIDE cases

 **TST2129K** Specific holder for soft side bags

 **BF27K** Specific flange for fitting the tank bags with TANKLOCK system

 **KD2129S** Specific screen, smoked 53,5 x 42 cm (H x W) to be mounted instead of the original screen

**KD2129B** Specific low and sports screen gloss black 36 x 36 cm (H x W) to be mounted instead of the original screen

 **01SKITK** Specific kit to mounting the KS900A Smart Bar

**YAMAHA BT 1100 BULLDOG (02 → 09)**















 **KZ350** Specific rear rack for **MONOKEY®** or **MONOLOCK®** top-case to be combined with the **MONOKEY®** KM5, KM7, KM8A, KM8B, KM9A or KM9B plate, or with the **MONOLOCK®** KM5M or KM6M plate / if combined with KM8A, KM8B, KM9A, KM9B it does not allow the assembly of the stop light kit or the remote control device on the case













**YAMAHA XV 1100 VIRAGO (89 → 99)**

 **23A** Universal screen, 38,8 x 41 cm (H x W) only available if article AS99A2 is already fitted / low, transparent version

**A35NK** Universal screen, 54,9 x 46,8 cm (H x W) only available if article AS99A2 is already fitted / high and shaded bottom version



CODICE	DESCRIZIONE	PRICE
<b>YAMAHA XVS 1100 DRAG STAR (99 → 02)</b>		
 <b>A35NK</b>	Universal screen, 54,9 x 46,8 cm (H x W) <i>to be combined with the specific AS100A2K fitting kit</i>	
<b>23A</b>	Universal screen, 38,8 x 41 cm (H x W) <i>to be combined with the specific AS100A2K fitting kit</i>	
<b>AS100A2K</b>	Specific fitting kit for 23A and A35NK	
<b>YAMAHA XVS 1100 DRAG STAR CLASSIC (00 → 02)</b>		
 <b>A39K</b>	Universal screen, transparent 51,7 x 57,3 cm (H x W) <i>to be combined with the specific AS102A2 fitting kit/ High version</i>	
<b>YAMAHA FJ 1100</b>		
 <b>K2970</b>	Specific rear rack for <b>MONOKEY</b> ® or <b>MONOLOCK</b> ® top-case <i>To be combined with the plate <b>MONOKEY</b>® K553N, or with the plate <b>MONOLOCK</b>® MKN</i>	
<b>YAMAHA XT 1200 Z SUPERTENERÉ (10 → 18)</b>		
 <b>KRA2101</b>	Specific rear rack in aluminium for <b>MONOKEY</b> ® top-case <i>It can only be mounted to the original rack / it can be fitted with the original side-case / to open the original side-cases you ought to remove the back top-case from the plate / maximum load allowed 6kg / it does not allow the assembly of the stop light kit or the remote control device on the case</i>	
<b>KR371</b>	Specific rear rack for <b>MONOKEY</b> ® top-case <b>MONOKEY</b> ® plate included / is compatible with the original side-case holder / to open the original side-cases you ought to remove the back top-case from the plate	
 <b>KL2119</b>	Specific pannier holder for <b>MONOKEY</b> ®, RETRO FIT side-cases	
<b>KLR2119</b>	Specific rapid release side-case holder for <b>MONOKEY</b> ®, RETRO FIT cases	
 <b>BF05K</b>	Specific flange for fitting the tank bags with TANKLOCK system	
 <b>KD447ST</b>	Specific screen, transparent 57 x 44 cm (H x W) <i>to be mounted instead of the original screen / 13 cm higher than the original / not compatible on version with a height adjustable windshield</i>	
<b>KD2119ST</b>	Specific screen, transparent 56,5 x 50 cm (h x w) <i>only compatible with version with a height adjustable windshield / to be mounted instead of the original screen / 11 cm higher than original</i>	
<b>KAF447</b>	Specific Airstream sliding wind-screen transparent. Maximum height 61 cm (12 cm of extension), width 43 cm <i>to be mounted instead of the original screen / not compatible on version with a height adjustable windshield</i>	
 <b>KN355</b>	Specific engine guard <i>25 mm diameter steel tube / we recommend fitting by a qualified mechanic / black colour</i>	
 <b>KTL2119KIT</b>	Specific kit to install the KS250 Tool Box beneath the KN355 engine guard <i>to be combined with KS250 and KN355 / it can be mounted on either the right-hand side or left-hand side of the motorcycle</i>	
 <b>RP2119K</b>	Oil carter protector in Aluminium	
<b>YAMAHA XT 1200 ZE SUPERTENERÉ (14 → 18)</b>		
 <b>KRA2101</b>	Specific rear rack in aluminium for <b>MONOKEY</b> ® top-case <i>It can only be mounted to the original rack / it can be fitted with the original side-case / to open the original side-cases you ought to remove the back top-case from the plate / maximum load allowed 6kg / it does not allow the assembly of the stop light kit or the remote control device on the case</i>	
<b>KR371</b>	Specific rear rack for <b>MONOKEY</b> ® top-case <i>You must remove the original rack / <b>MONOKEY</b>® plate included / is compatible with the original side-case holder / to open the original side-cases you ought to remove the back top-case from the plate</i>	
 <b>KL2119</b>	Specific pannier holder for <b>MONOKEY</b> ®, RETRO FIT side-cases	
<b>KLR2119</b>	Specific rapid release side-case holder for <b>MONOKEY</b> ®, RETRO FIT cases	
 <b>BF05K</b>	Specific flange for fitting the tank bags with TANKLOCK system	
 <b>KD2119ST</b>	Specific screen, transparent 56,5 x 50 cm (h x w) <i>to be mounted instead of the original screen / 11 cm higher than original</i>	
 <b>RP2119K</b>	Oil carter protector in Aluminium	

CODICE	DESCRIZIONE	PREZZO
<b>KN355</b>	Specific engine guard <i>25 mm diameter steel tube / we recommend fitting by a qualified mechanic / black colour</i>	
 <b>KTL2119KIT</b>	Specific kit to install the KS250 Tool Box beneath the KN355 engine guard <i>to be combined with KS250 and KN355 / it can be mounted on either the right-hand side or left-hand side of the motorcycle</i>	
<b>VARIOUS ACCESSORIES</b> <b>ES2119K</b>	Specific support in aluminium and stainless steel to widen the surface support area of the original side stand	
<b>01SKITK</b>	Specific kit to mounting the KS900A Smart Bar	
<b>YAMAHA XJR 1200 (95 → 98)</b>		
 <b>K3410</b>	Specific rear rack for <b>MONOKEY</b> ® or <b>MONOLOCK</b> ® top-case <i>To be combined with the plate <b>MONOKEY</b>® K553N, or with the plate <b>MONOLOCK</b>® MKN</i>	
<b>YAMAHA FJR 1300 (01 → 05)</b>		
 <b>KR346</b>	Specific rear rack for <b>MONOKEY</b> ® top-case <i>is compatible with the original side-case holder / <b>MONOKEY</b>® plate included / maximum load allowed 6 Kg</i>	
<b>KR346M</b>	Specific rear rack for <b>MONOLOCK</b> ® top-case <i>is compatible with the original side-case holder / <b>MONOLOCK</b>® plate included / maximum load allowed 6 Kg</i>	
 <b>KD134ST</b>	Specific screen, transparent 47 x 51 cm (H x W) <i>to be mounted instead of the original screen / 5 cm higher than the original</i>	
<b>YAMAHA FJR 1300 (06 → 12)</b>		
 <b>KRA2109</b>	Specific rear rack in aluminium for <b>MONOKEY</b> ® top-case <i>maximum load allowed 6kg / it does not allow the assembly of the stop light kit or the remote control device on the case</i>	
<b>K228</b>	Specific rear rack for <b>MONOKEY</b> ® top-case <i>maximum load allowed 6 Kg / <b>MONOKEY</b>® plate included</i>	
<b>K228M</b>	Specific rear rack for <b>MONOLOCK</b> ® top-case <i>maximum load allowed 6 Kg / <b>MONOLOCK</b>® plate included</i>	
<b>KR357</b>	Specific rear rack for <b>MONOKEY</b> ® top-case <b>MONOKEY</b> ® plate included	
 <b>BF05K</b>	Specific flange for fitting the tank bags with TANKLOCK system	
 <b>KD436ST</b>	Specific screen, transparent 52 x 49,5 cm (H x W) <i>to be mounted instead of the original screen / 5 cm higher than the original</i>	
<b>YAMAHA FJR 1300 (13 → 18)</b>		
 <b>KRA2109</b>	Specific rear rack in aluminium for <b>MONOKEY</b> ® top-case <i>maximum load allowed 6kg / it does not allow the assembly of the stop light kit or the remote control device on the case</i>	
<b>K228</b>	Specific rear rack for <b>MONOKEY</b> ® top-case <i>maximum load allowed 6 Kg / <b>MONOKEY</b>® plate included</i>	
<b>K228M</b>	Specific rear rack for <b>MONOLOCK</b> ® top-case <i>maximum load allowed 6 Kg / <b>MONOLOCK</b>® plate included</i>	
<b>KR357</b>	Specific rear rack for <b>MONOKEY</b> ® top-case <b>MONOKEY</b> ® plate included	
<b>YAMAHA XJR 1300 (98 → 02)</b>		
 <b>K3410</b>	Specific rear rack for <b>MONOKEY</b> ® or <b>MONOLOCK</b> ® top-case <i>To be combined with the plate <b>MONOKEY</b>® K553N, or with the plate <b>MONOLOCK</b>® MKN</i>	
<b>YAMAHA XJR 1300 (04 → 06)</b>		
 <b>K3550</b>	Specific rear rack for <b>MONOKEY</b> ® or <b>MONOLOCK</b> ® top-case <i>To be combined with the plate <b>MONOKEY</b>® K553N, or with the plate <b>MONOLOCK</b>® MKN</i>	
<b>YAMAHA XJR 1300 (07 → 14)</b>		
 <b>K3610</b>	Specific rear rack for <b>MONOKEY</b> ® or <b>MONOLOCK</b> ® top-case <i>To be combined with the plate <b>MONOKEY</b>® K553N, or with the plate <b>MONOLOCK</b>® MKN</i>	
 <b>BF05K</b>	Specific flange for fitting the tank bags with TANKLOCK system	
<b>VARIOUS ACCESSORIES</b> <b>05SKITK</b>	Specific kit to mounting the KS900A Smart Bar	

→ CODICE	DESCRIZIONE	PRICE
-------------	-------------	-------

## ZERO MOTORCYCLES

### ZERO MOTORCYCLES ZERO DS (18) **NEW**

<b>VARIOUS ACCESSORIES</b>	<b>05SKITK</b>	Specific kit to mounting the KS900A Smart Bar <i>also for version DSR</i>
----------------------------	----------------	--

### ZERO MOTORCYCLES R 850 R (03 → 07)

	<b>KR683</b>	Specific rear rack for <b>MONOKEY</b> ® top-case <i>is not compatible with the R850R Comfort / MONOKEY® plate included / to be mounted only with the original side-case holder / maximum load allowed 6 Kg</i>
--	--------------	---

### ZERO MOTORCYCLES DOMINATOR 650 (← 92)

	<b>K200</b>	Specific rear rack for <b>MONOKEY</b> ® top-case <b>MONOKEY</b> ® plate included
--	-------------	---

### ZERO MOTORCYCLES DOMINATOR 650 (92 → 94)

	<b>K200</b>	Specific rear rack for <b>MONOKEY</b> ® top-case <b>MONOKEY</b> ® plate included
--	-------------	---

### ZERO MOTORCYCLES VT 600 C SHADOW (89 → 01)

	<b>A35NK</b>	Universal screen, 54,9 x 46,8 cm (H x W) <i>to be combined with the specific AS100A2K fitting kit</i>
	<b>23A</b>	Universal screen, 38,8 x 41 cm (H x W) <i>to be combined with the specific AS100A2K fitting kit</i>
	<b>AS100A2K</b>	Specific fitting kit for 23A and A35NK

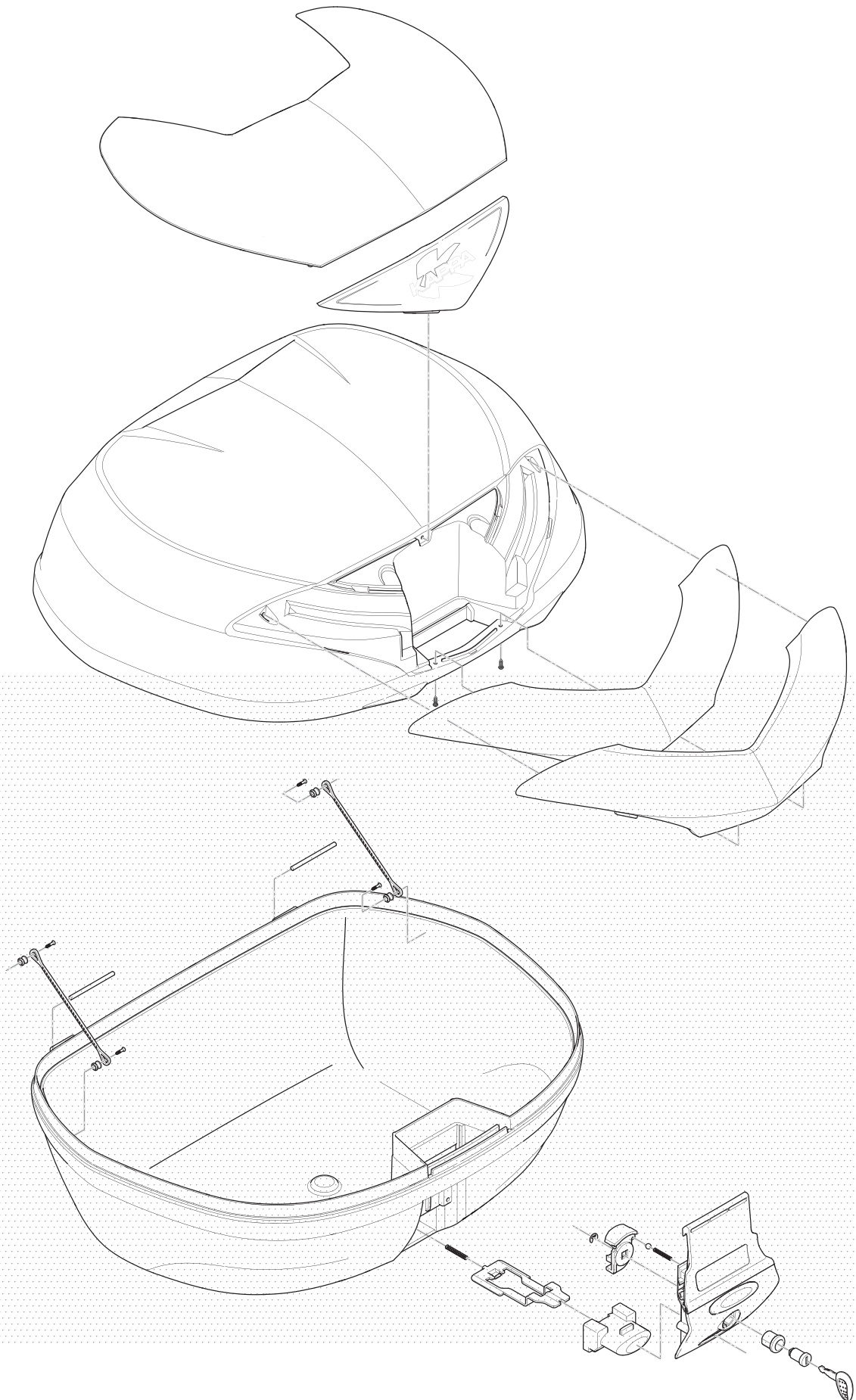

→ PLATES & SPARE PARTS

## → PLATES

Various solutions are available to combine a top case with motorcycle models having a standard carrier or adaptation available to accept a top case. Plates are a simple solution to enhance the functionality of the motorcycle.

**K628** Universal nylon plate, included in the MONOLOCK® top-case



**K636** Universal MONOKEY® plate with fitting kit to fit a case on a scooter already with a rack



**K553N** Joint Z890K and nylon plate with fitting kit, to be mounted with Monorack K.... Suitable for MONOKEY® top-case



**K553L** Joint 35 mm Z896K and nylon plate, to be mounted Monorack K...L. Suitable for MONOKEY® top-case



**MKN** Joint (Z890K) and plate in aluminium with fitting kit, to be mounted with Monorack K.... Suitable for MONOLOCK® top-case



**MKL** Joint set (Z896K) and plate in aluminium, to be mounted with Monorack K...L. Suitable for MONOLOCK® top-cases



**KM5** Nylon top plate with fitting kit included, to be mounted with Monorack KZ and KR. Suitable for MONOKEY® top-cases



**KM5M** Nylon top plate with fitting kit included, to be mounted with Monorack KZ and KR. Suitable for MONOLOCK® top-cases



**KM6M** Monolock® Plate in nylon with place for the "u" type padlock to be used with Monorack KZ



**KM7** MONOKEY® Nylon plate to be mounted with Monorack KZ



**KM8A** Anodized aluminium MONOKEY® plate to be combined with the specific racks KZ and with the specific rear racks KR where expressly indicated



**KM8B** Black anodized aluminium MONOKEY® plate to be combined with the specific racks KZ and with the specific rear racks KR where expressly indicated



**KM9A**  
→NEW MONOKEY® Plate. Made from aluminium 3 mm brushed and anodized aluminium, with the specific racks KZ or with the specific rear racks KR where expressly indicated  
**DOES NOT ALLOW THE MOUNTING OF A STOP LIGHT KIT / REMOTE-CONTROLLED OPENING KIT**



**KM9B**  
→NEW MONOKEY® Plate. Made from black aluminium 3 mm brushed and anodized aluminium, with the specific racks KZ or with the specific rear racks KR where expressly indicated  
**DOES NOT ALLOW THE MOUNTING OF A STOP LIGHT KIT / REMOTE-CONTROLLED OPENING KIT**



### SPARE PARTS

- Z622MK** Nylon plate for MONOKEY® cases
- Z667MK** Nylon plate for MONOLOCK® cases
- Z340K** Aluminium plate for MONOLOCK® cases
- Z255K** Nylon plate for MONOKEY® cases
- Z4400RK** Universal MONOKEY® plate
- Z4401KR** Cover Plate for universal MONOKEY® plate
- Z114K** Cover plate for Z113
- Z2710K** Plate rubber parts
- Z2710AK** Antivibration rubber grommets (with increased height – set of 4) for KM7/K636/KRA
- Z621RK** Hole covering caps
- Z126K** Plate rubber Monorack/Wingrack
- Z113-2K** Spare plate for universal MONOLOCK® plate
- Z9571RK** Set of 4 pcs flat rubber cushions with plastic base for plates KM9A, KM9B, KRA... (for KRA it is necessary to verify the type of rubber cushion installed)
- Z2309RK** Support hooks with screws for KRA, KM8A, KM8B

## MONORACK® K.. - KZ... - K...L

Highly tested and compatible with the whole range of KAPPA MONOKEY® and MONOLOCK® cases, the MONORACK fitting system for top-cases is composed of a light alloy or plastic plate mounted by the exclusive a every situation. Practicality and ease of use are guaranteed by the quick and essential assembling/disassembling system and by the availability of specific fitting Kits for the latest motorcycle models.

## K1200 UNIVERSAL MONORACK

**K1200** Universal rear rack for MONOKEY® or MONOLOCK® top-case without plate and joint set  
**TO BE COMBINED WITH THE MONOKEY® K553N PLATE, OR WITH THE MONOLOCK® MKN PLATE**



## KVE58\_ / KVE48\_ / KVE42\_ K - VENTURE TOP-CASE

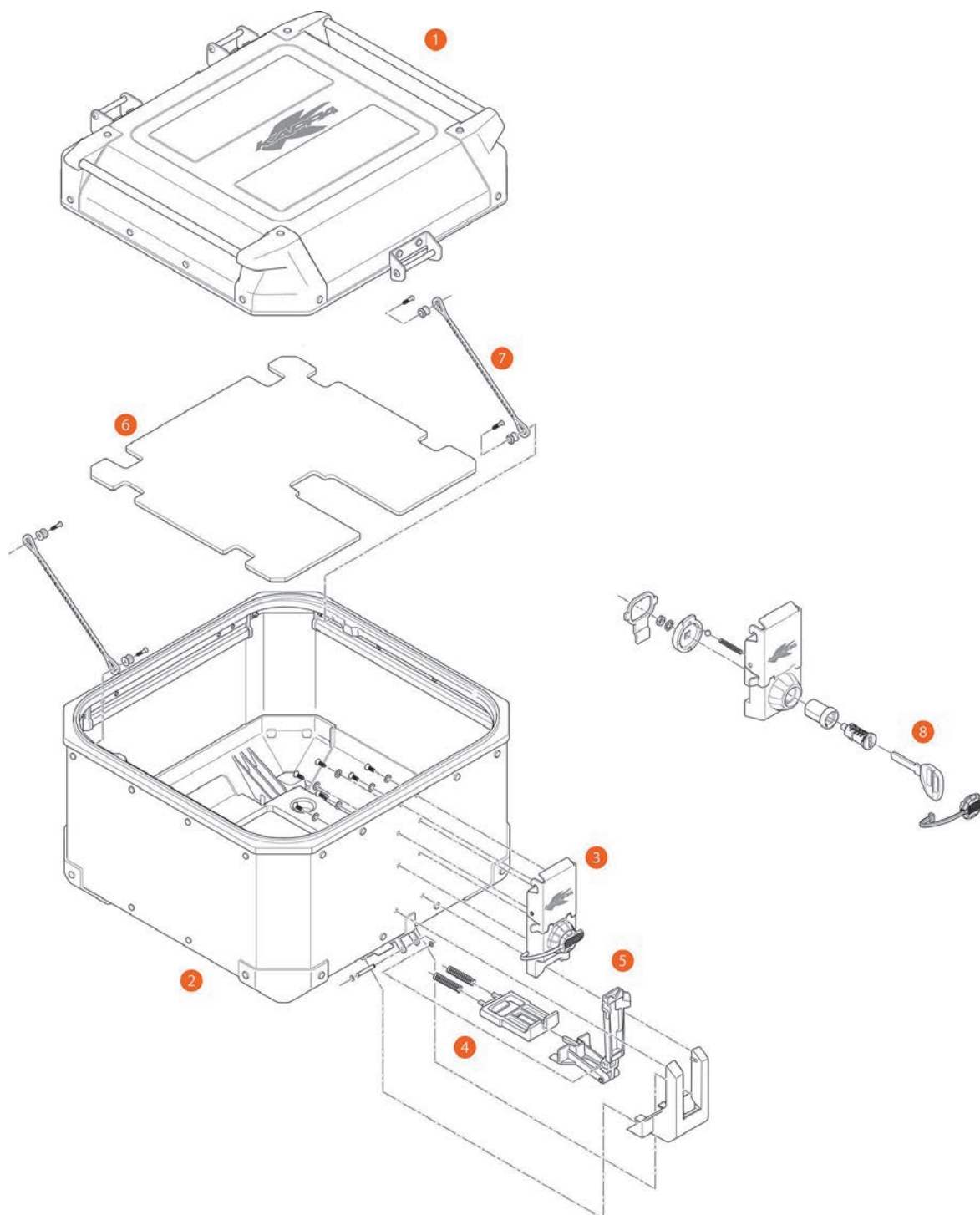

1	<b>ZKVE58ACM</b>	KVE58A assembled top-shell		
1	<b>ZKVE58CBM</b>	KVE58B top-shell, black painted		
1	<b>ZKVE42ACM</b>	KVE42A assembled top-shell		
1	<b>ZKVE42CBM</b>	KVE42B top-shell, black painted		
2	<b>ZKVE58AFM</b>	KVE58A assembled bottom-shell		
2	<b>ZKVE58FBM</b>	KVE58B bottom-shell, black painted		
2	<b>ZKVE42AFM</b>	KVE42A assembled bottom-shell		
2	<b>ZKVE42FBM</b>	KVE42B bottom-shell, black painted		

3	<b>Z8024MKR</b>	Mounted lock set for KVE42, KVE58		
4	<b>Z1782CRK</b>	Bolt with springs		
5	<b>Z8025RK</b>	Mounted release system		
6	<b>Z8099RK</b>	Inner carpet top-case 42 ltr		
7	<b>Z115RK</b>	Stop bag opening yarn, 2 pcs.		
8	<b>KSL101</b>	Set of 1 key locks with corresponding bush including under lock platelets.		

# KVE37\_PACK2 K-VENTURE

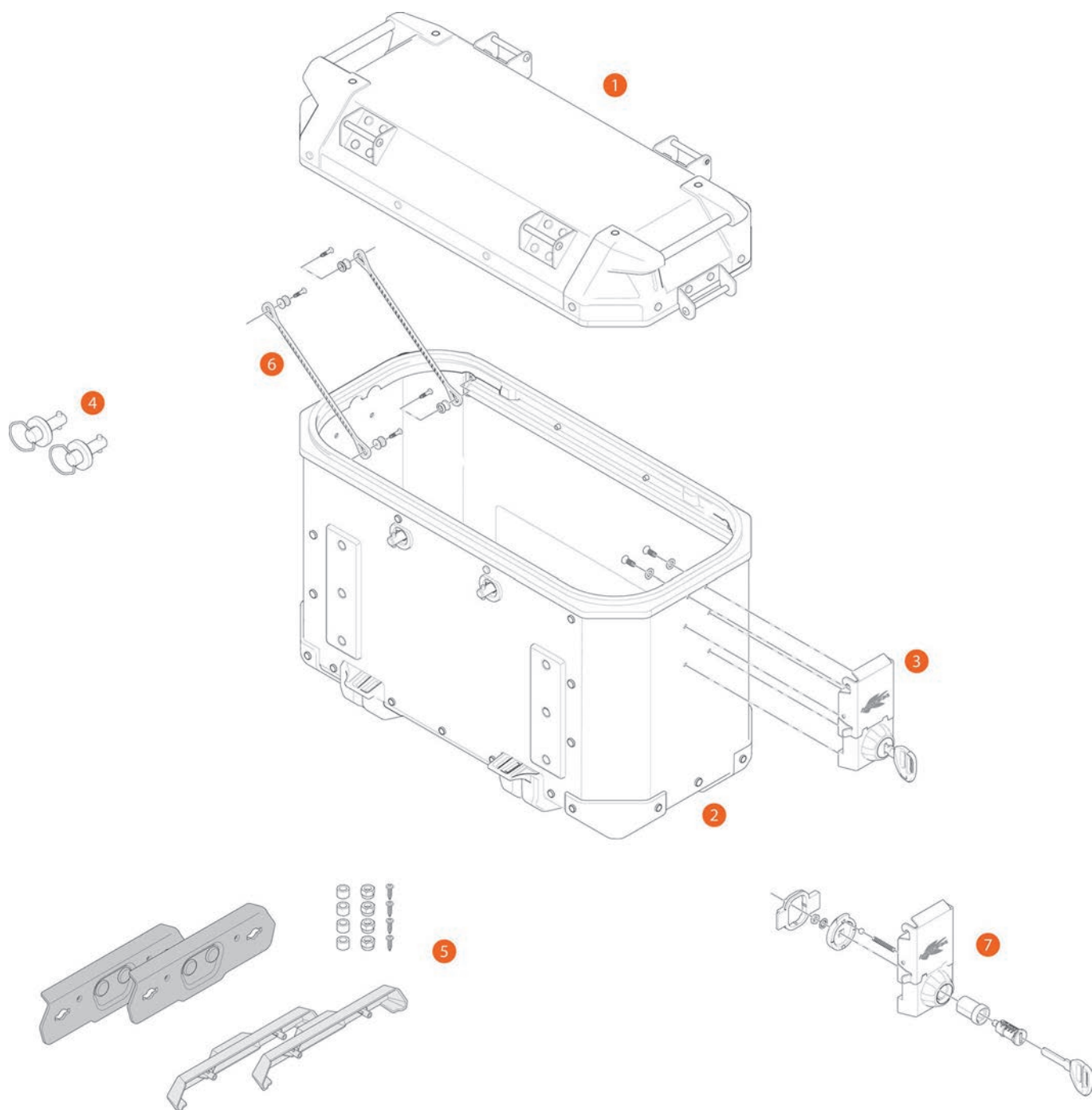

1	<b>ZKVE37ALCM</b>	KVE37A assembled top-shell (left)		
1	<b>ZKVE37ARCM</b>	KVE37A assembled top-shell (right)		
1	<b>ZKVE37BLCM</b>	KVE37B top-shell, black painted (left)		
1	<b>ZKVE37BRCM</b>	KVE37B top-shell, black painted (right)		
2	<b>ZKVE37ALFM</b>	KVE37A assembled bottom-shell (left)		
2	<b>ZKVE37ARFM</b>	KVE37A assembled bottom-shell (right)		
2	<b>ZKVE37BLFM</b>	KVE37B bottom-shell, black painted (left)		
2	<b>ZKVE37BRFM</b>	KVE37B bottom-shell, black painted (right)		

3	<b>Z4822DXMKR</b>	K-venture complete hinge (right)		
3	<b>Z48225XMKR</b>	K-venture complete hinge (left)		
4	<b>ST9034KKITR</b>	Fitting kit for KVE37		
5	<b>KVE37KITR</b>	Fitting kit for PL		
6	<b>Z115RK</b>	Stop bag opening yarn, 2 pcs.		
7	<b>KSL101</b>	Set of 1 key locks with corresponding bush including under lock platelets.		



# KGR52\_ GARDA

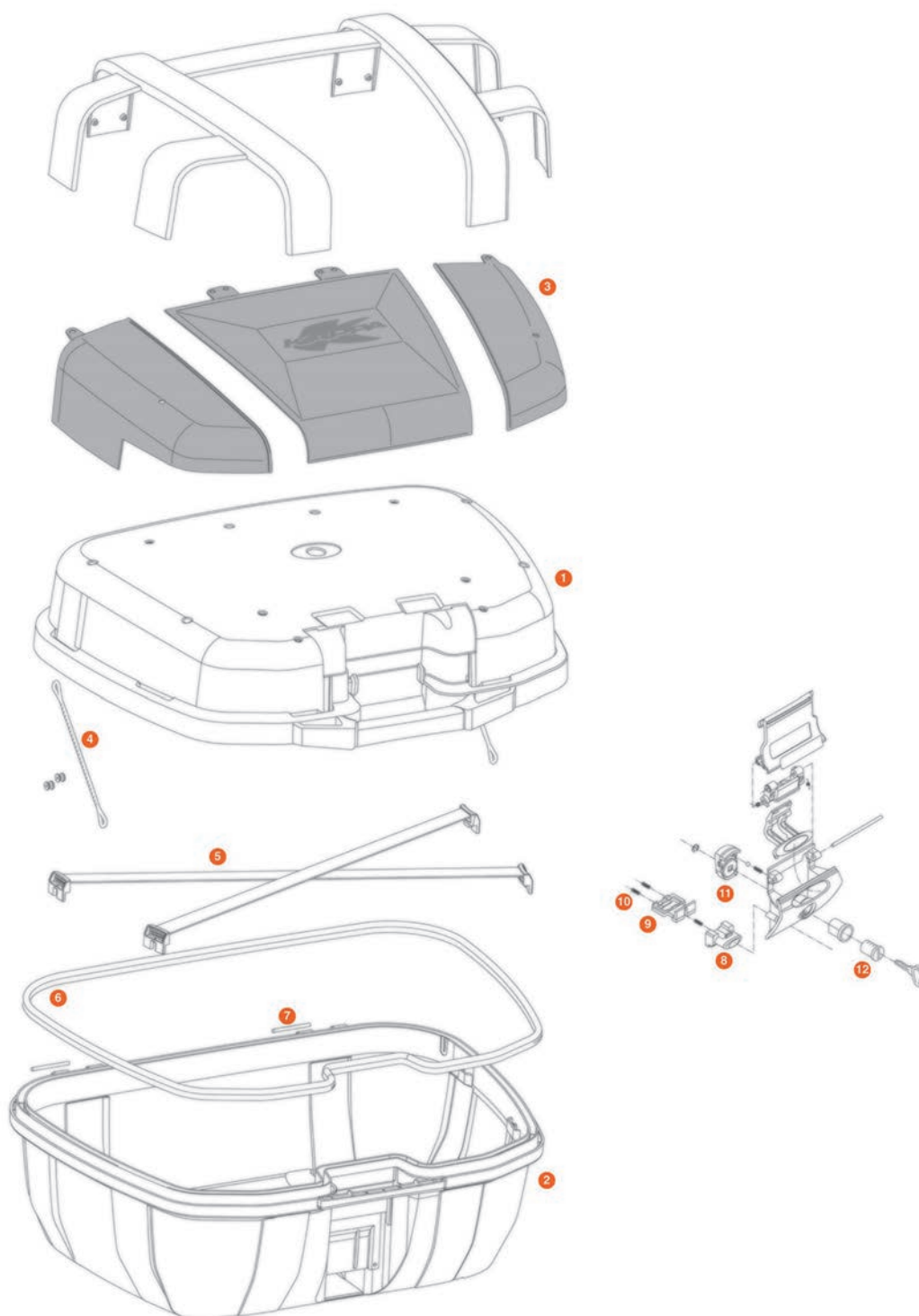

1	<b>ZKGR52CNM</b>	Mounted top-shell KGR52		
2	<b>ZKGR52FNM</b>	Mounted bottom-shell KGR52		
3	<b>Z4720A900R</b>	Painted cover		
4	<b>Z115RK</b>	Stop bag opening yarn, 2 pcs.		
5	<b>Z2170NR</b>	Elastic belt		
6	<b>Z3220RK</b>	Rubber seal		
7	<b>Z590RK</b>	Pin. Medium, 2 pcs.		

8	<b>Z645CRK</b>	Push button chromed		
9	<b>Z106K</b>	Bolt		
10	<b>Z109K</b>	Long bolt springs		
11	<b>Z640RK</b>	Plate below lock, 1 pcs.		
12	<b>K500N</b>	Lock key black, 1 kit		
	<b>Z641NK46M</b>	Complete hinge		
	<b>Z2202RK</b>	Black bands for KGR52 top-shell		

# KGR46\_ / KGR33\_ GARDA

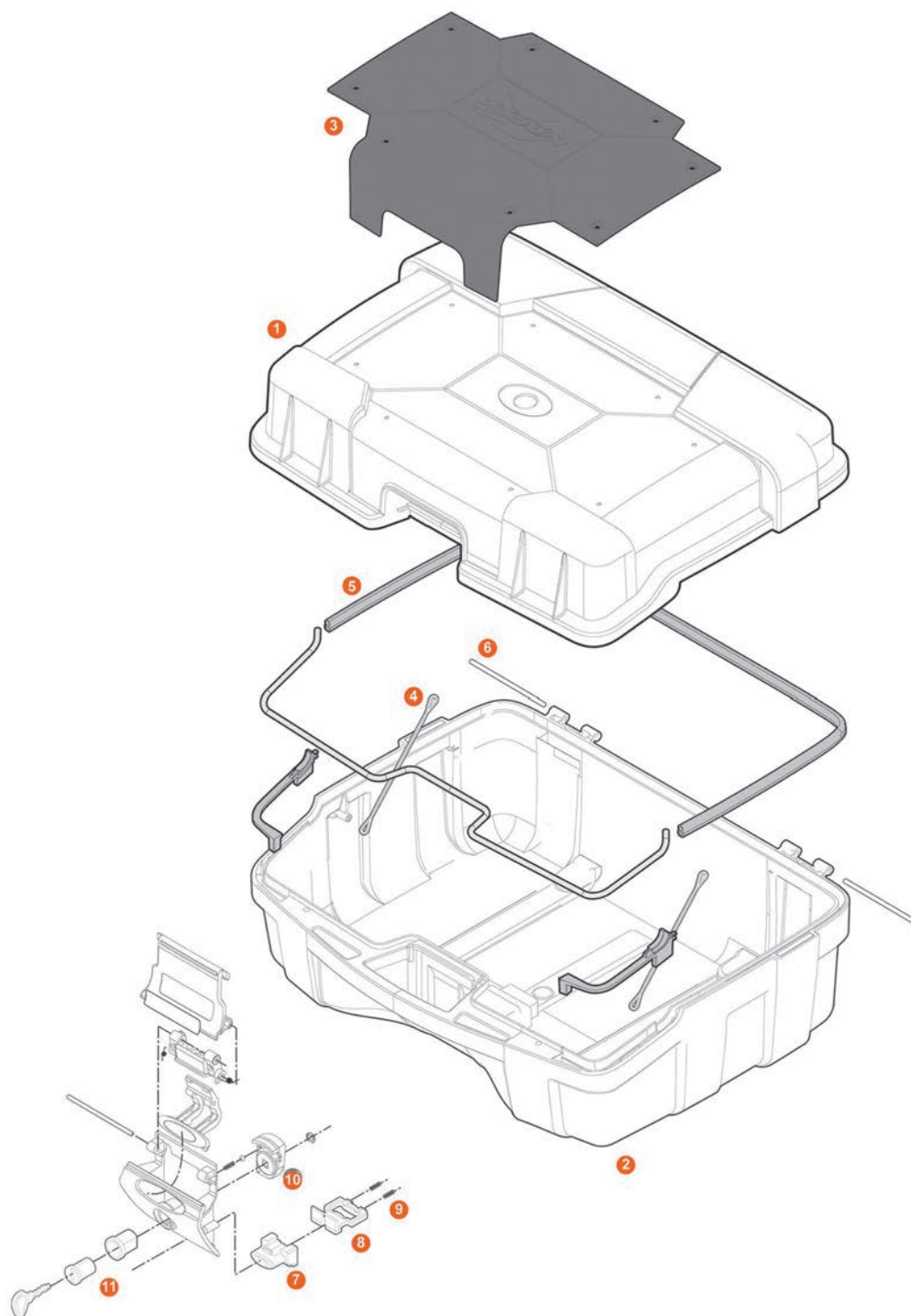

1	<b>ZKGR46FNM</b>	Mounted top-shell		
2	<b>ZKGR33FNM</b>	KGR33 mounted bottom-shell		
3	<b>Z2291A900R</b>	Painted cover		
4	<b>Z115RK</b>	Stop bag opening yarn, 2 pcs.		
5	<b>Z2072RK</b>	Rubber seal		
6	<b>Z590RK</b>	Pin. Medium, 2 pcs.		
7	<b>Z645CRK</b>	Push button chromed		

8	<b>Z106K</b>	Bolt		
9	<b>Z109K</b>	Long bolt springs		
10	<b>Z640RK</b>	Plate below lock, 1 pcs.		
11	<b>K500N</b>	Lock key black, 1 kit		
	<b>Z641NK46M</b>	KGR46 complete hinge		
	<b>Z641NK33M</b>	KGR33 complete hinge		
	<b>Z2106NR</b>	Inner elastic belt, 1 pcs.		
	<b>GR2701KITR</b>	Spare parts kit for hinge		

# K56 / K56 TECH

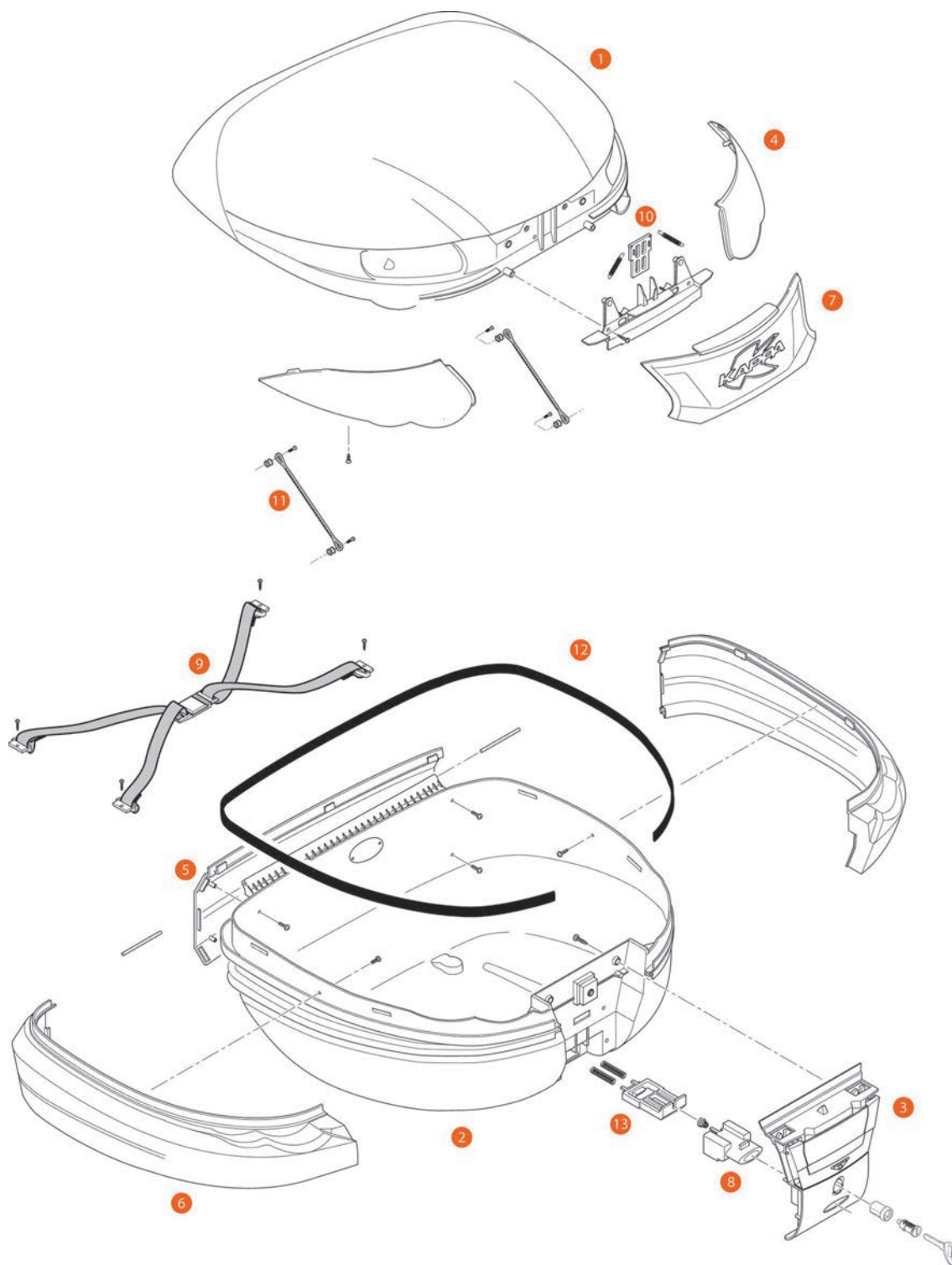

1	<b>ZK56CNM</b>	Assembled top-shell, black		
1	<b>ZK56CNTM</b>	Assembled top-shell (version NT)		
2	<b>ZK56FNM</b>	Assembled bottom-shell, black		
2	<b>ZK56FNTM</b>	Assembled bottom-shell (version NT)		
3	<b>ZK398NMR</b>	Hinge, complete		
4	<b>Z5504R</b>	Red reflectors		
4	<b>Z5504FR</b>	Smoked reflectors		
5	<b>Z692G7880PR</b>	Rear band		
6	<b>Z693G7880PR</b>	Side bands		

7	<b>Z5501G7880PR</b>	Embossed logo plate		
8	<b>Z206RK</b>	Button + Button Spring		
8	<b>Z206NRK</b>	Black button + button spring		
9	<b>K566XKR</b>	Inner elastic belt		
10	<b>Z677RK</b>	Lock key system for top-shell		
11	<b>Z664K</b>	Stop bag opening yarn with plastic sleeve		
12	<b>Z1908RK</b>	Lock lining		
13	<b>Z1782RK</b>	Bolt + bolt springs		

## K53N

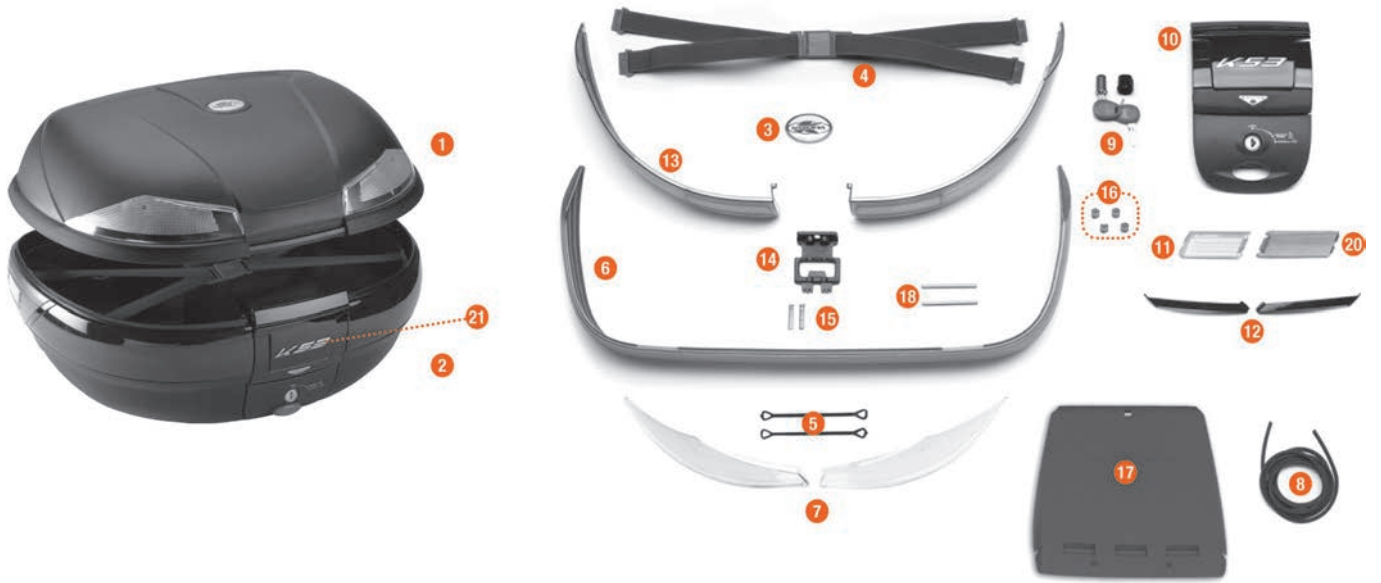

1	<b>Z53CNM</b>	Top-shell, black (mounted)		
2	<b>Z53FNM</b>	Bottom-shell, black (mounted)		
3	<b>Z1632R</b>	Oval KAPPA Logo, in aluminium, 1 pcs.		
4	<b>Z633KR</b>	Elastic belt		
5	<b>Z115RK</b>	Stop bag opening yarn, 2 pcs.		
6	<b>Z218GR</b>	Grey rear band (left sx / right dx)		
7	<b>Z950TR</b>	Reflector set		
8	<b>Z159RK</b>	Bag lock lining, 1 pcs.		
10	<b>Z683NR</b>	Complete hinge		
11	<b>Z289KR</b>	Name-Address holder		

12	<b>Z686NR</b>	Small black decoration set		
13	<b>Z223TRK</b>	Set Bottom Reflector		
14	<b>Z106K</b>	Bolt		
15	<b>Z109K</b>	Long bolt springs		
16	<b>Z339K</b>	Red pulley		
17	<b>Z160K</b>	Inner document holder		
18	<b>Z590RK</b>	Pin. Medium, 2 pcs.		
	<b>Z206RK</b>	Button + Button Spring		
20	<b>Z286K</b>	Glass for small name plate		
21	<b>Z1918R</b>	Logo "K53"		

## K52

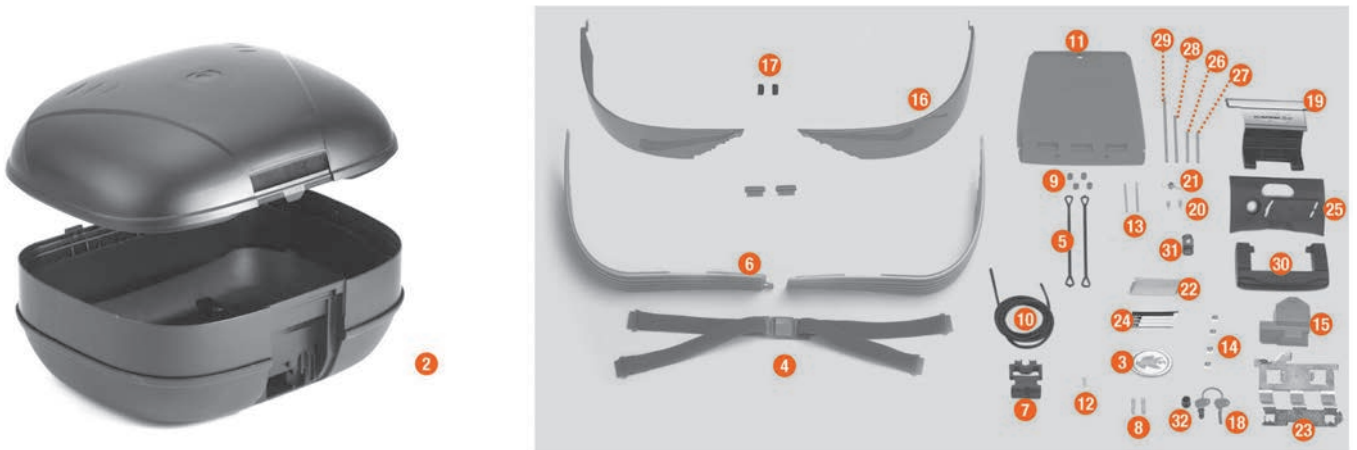

2	<b>Z50FNMK</b>	Bottom-shell, black (mounted)		
3	<b>Z1632R</b>	Oval KAPPA Logo, in aluminium, 1 pcs.		
4	<b>K566</b>	Elastic belt		
5	<b>Z115RK</b>	Stop bag opening yarn, 2 pcs.		
7	<b>Z106K</b>	Bolt		
8	<b>Z109K</b>	Long bolt springs		
9	<b>Z112RK</b>	Red pulley, 4 pcs.		
10	<b>Z159RK</b>	Bag lock lining, 1 pcs.		
11	<b>Z160K</b>	Inner document holder		
12	<b>Z1237K</b> ↘	Push button spring with washer		
13	<b>Z590RK</b>	Pin. Medium, 2 pcs.		

17	<b>Z298K</b>	Handle felt		
18	<b>K500</b>	Lock key, 1 kit		
22	<b>Z286K</b>	Glass for small name plate		
23	<b>Z287K</b>	Lock plate		
24	<b>Z289KR</b>	Name-Address holder		
25	<b>Z290NK</b> ↘	Hinge black		
26	<b>Z294</b>	Pin 55,5 mm		
28	<b>Z296K</b>	Pin 101 mm		
29	<b>Z297K</b>	Pin 140 mm		
32	<b>Z210K</b>	Chrome bushing for lock set		

## K48



1	<b>K48CNM</b>	Top-shell, black (mounted)		
2	<b>K48FNM</b>	Bottom-shell, black (mounted)		
4	<b>Z159RK</b>	Bag lock lining, 1 pcs.		
5	<b>Z195K</b>	Pin D. 04x80 mm		
6	<b>Z210K</b>	Chrome bushing for lock set		
7	<b>Z312K</b>	Hinge plate		
8	<b>Z314NK</b>	Hinge black		
8	<b>Z314NM2K</b>	Hinge, complete black		
9	<b>K546</b>	Name-Address holder		
10	<b>Z1632R</b>	Oval KAPPA Logo, in aluminium, 1 pcs.		
11	<b>K558</b>	Plate for reflector		
12	<b>Z217K</b>	Push button		

13	<b>Z106K</b>	Bolt		
14	<b>Z109K</b>	Long bolt springs		
15	<b>Z1237K</b> ↘	Push button spring with washer		
16	<b>Z277K</b>	Plate below lock		
17	<b>Z115RK</b>	Stop bag opening yarn, 2 pcs.		
18	<b>K566</b>	Elastic belt		
19	<b>K615</b>	Reflector		
20	<b>Z337K</b>	Top-case reflector		
21	<b>Z112RK</b>	Red pulley, 4 pcs.		
22	<b>615KA</b>	White sticker for K615		
23	<b>Z590RK</b>	Pin. Medium, 2 pcs.		
24	<b>K500</b>	Lock key, 1 kit		

## K961

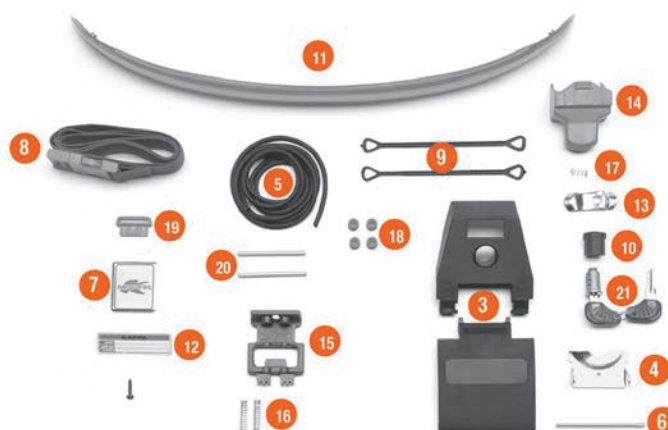

1	<b>K96CN</b>	Top-shell, black		
2	<b>K96FN</b>	Bottom-shell, black		
5	<b>Z159RK</b>	Bag lock lining, 1 pcs.		
6	<b>Z195K</b>	Pin D. 04x80 mm		
7	<b>K513</b>	Logo KAPPA		
8	<b>K517</b>	Belt		
9	<b>Z664K</b>	Stop bag opening yarn with plastic sleeve		
10	<b>Z210K</b>	Chrome bushing for lock set		
12	<b>K546</b>	Name-Address holder		

13	<b>K554</b>	Plate Below Lock		
14	<b>Z217K</b>	Push button		
15	<b>Z106K</b>	Bolt		
16	<b>Z109K</b>	Long bolt springs		
17	<b>Z1237K</b> ↘	Push button spring with washer		
18	<b>Z112RK</b>	Red pulley, 4 pcs.		
19	<b>Z155K</b>	Straps holder		
20	<b>Z590RK</b>	Pin. Medium, 2 pcs.		
21	<b>K500</b>	Lock key, 1 kit		

## K21N

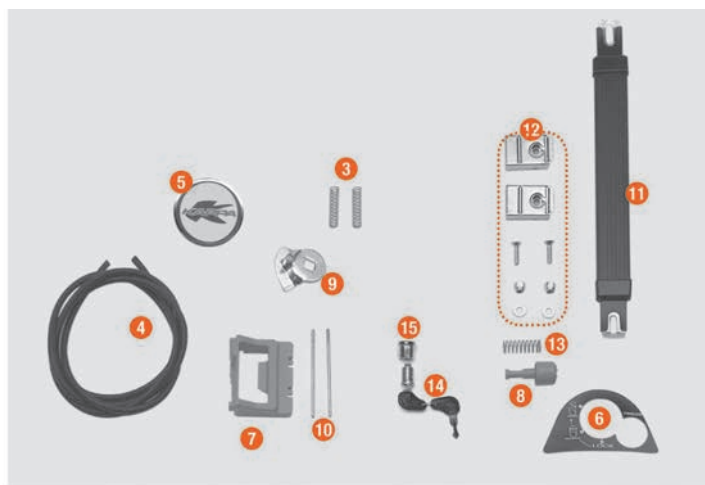

3	<b>Z109K</b>	Long bolt springs		
4	<b>Z159RK</b>	Bag lock lining, 1 pcs.		
6	<b>Z325K</b>	Pannier opening sticker		
7	<b>Z387K</b>	Bolt		
8	<b>Z388K</b>	Push button		

10	<b>Z390K</b>	Pin D. 02x60 mm E21		
11	<b>Z605K</b>	Handle		
13	<b>Z831K</b>	Spring push button		
14	<b>K500</b>	Lock key, 1 kit		
15	<b>Z210K</b>	Chrome bushing for lock set		

## K40N



1	<b>K40CNMDX</b>	Top-shell, black (mounted-right)		
1	<b>K40CNMDX</b>	Top-shell, black (mounted-left)		
2	<b>K48FNM</b>	Bottom-shell, black (mounted)		
4	<b>Z159RK</b>	Bag lock lining, 1 pcs.		
5	<b>Z195K</b>	Pin D. 04x80 mm		
6	<b>Z210K</b>	Chrome bushing for lock set		
7	<b>Z312K</b>	Hinge plate		
8	<b>Z314NK</b>	Hinge black		
8	<b>Z314NM2K</b>	Hinge, complete black		
9	<b>K546</b>	Name-Address holder		
10	<b>Z1632R</b>	Oval KAPPA Logo, in aluminium, 1 pcs.		
11	<b>Z217K</b>	Push button		
12	<b>Z106K</b>	Bolt		
13	<b>Z109K</b>	Long bolt springs		

14	<b>Z1237K</b>	Push button spring with washer		
15	<b>Z277K</b>	Plate below lock		
16	<b>Z115RK</b>	Stop bag opening yarn, 2 pcs.		
17	<b>K566</b>	Elastic belt		
18	<b>K622N902</b>	Inserts Points		
19	<b>K623D</b>	Direction indicator (right)		
19	<b>K623S</b>	Direction indicator (left)		
20	<b>K624D</b>	Direction indicator (right)		
20	<b>K624S</b>	Direction indicator (left)		
21	<b>K625</b>	Plate for reflector with logo in relief		
22	<b>Z112RK</b>	Red pulley, 4 pcs.		
23	<b>Z590RK</b>	Pin, Medium, 2 pcs.		
24	<b>K500</b>	Lock key, 1 kit		

## K49 / K49 TECH



1	<b>K49CNM</b>	Top-shell, black (mounted)		
1	<b>K49CNTM</b>	Mounted top-shell (NT version)		
2	<b>K49FNM</b>	Bottom-shell, black (mounted)		
2	<b>K49FNMTM</b>	Mounted bottom-shell (NT version)		
3	<b>Z106K</b>	Bolt		
4	<b>Z109K</b>	Long bolt springs		
5	<b>Z112RK</b>	Red pulley, 4 pcs.		
6	<b>Z160K</b>	Inner document holder		
7	<b>K566</b>	Elastic belt		
8	<b>Z115RK</b>	Stop bag opening yarn, 2 pcs.		
9	<b>Z645RK</b>	Push button red, 1 pcs.		
	<b>Z644NRK</b>	Opening push button (NT version)		
	<b>Z645CRK</b>	Push button (NT version)		
10	<b>Z731K</b>	Top-case reflector (right and left)		
	<b>K731TR</b>	Pair of reflectors with silver background (NT version)		
11	<b>Z744RK</b>	Top-case reflector, 1 kit		
11	<b>Z744TR</b>	Central reflector (NT version)		
12	<b>Z734NSET</b>	Rear band set		

13	<b>Z741K</b>	Hook for fixing the document holder		
14	<b>Z1632R</b>	Oval KAPPA Logo, in aluminium, 1 pcs.		
15	<b>Z769K</b>	Rubber seal		
16	<b>Z409RK</b>	Name holder, 1 pcs.		
17	<b>Z630K</b>	Steel spheres D. 6		
18	<b>Z632RK</b>	Steel torsion spring		
19	<b>Z637RK</b>	Pin. D. 04x75 mm, (1 piece)		
20	<b>Z640RK</b>	Plate below lock, 1 pcs.		
21	<b>Z641NRK</b>	Hinge black		
22	<b>Z643RK</b>	Lock set element red, 1 pcs.		
23	<b>Z644RK</b>	Opening push button, 1 pcs.		
24	<b>Z647RK</b>	Torsion spring, 1 pcs.		
26	<b>Z721RK</b>	Pin. D. 04x85 mm		
27	<b>K500</b>	Lock key, 1 kit		
	<b>Z156NK</b>	Key lock complete of bushing and black cap (NT version)		
28	<b>Z210K</b>	Chrome bushing for lock set		
SN	<b>Z641NMK</b>	Hinge complete		
SN	<b>Z641NNM</b>	Complete hinge (NT version)		

# K22N

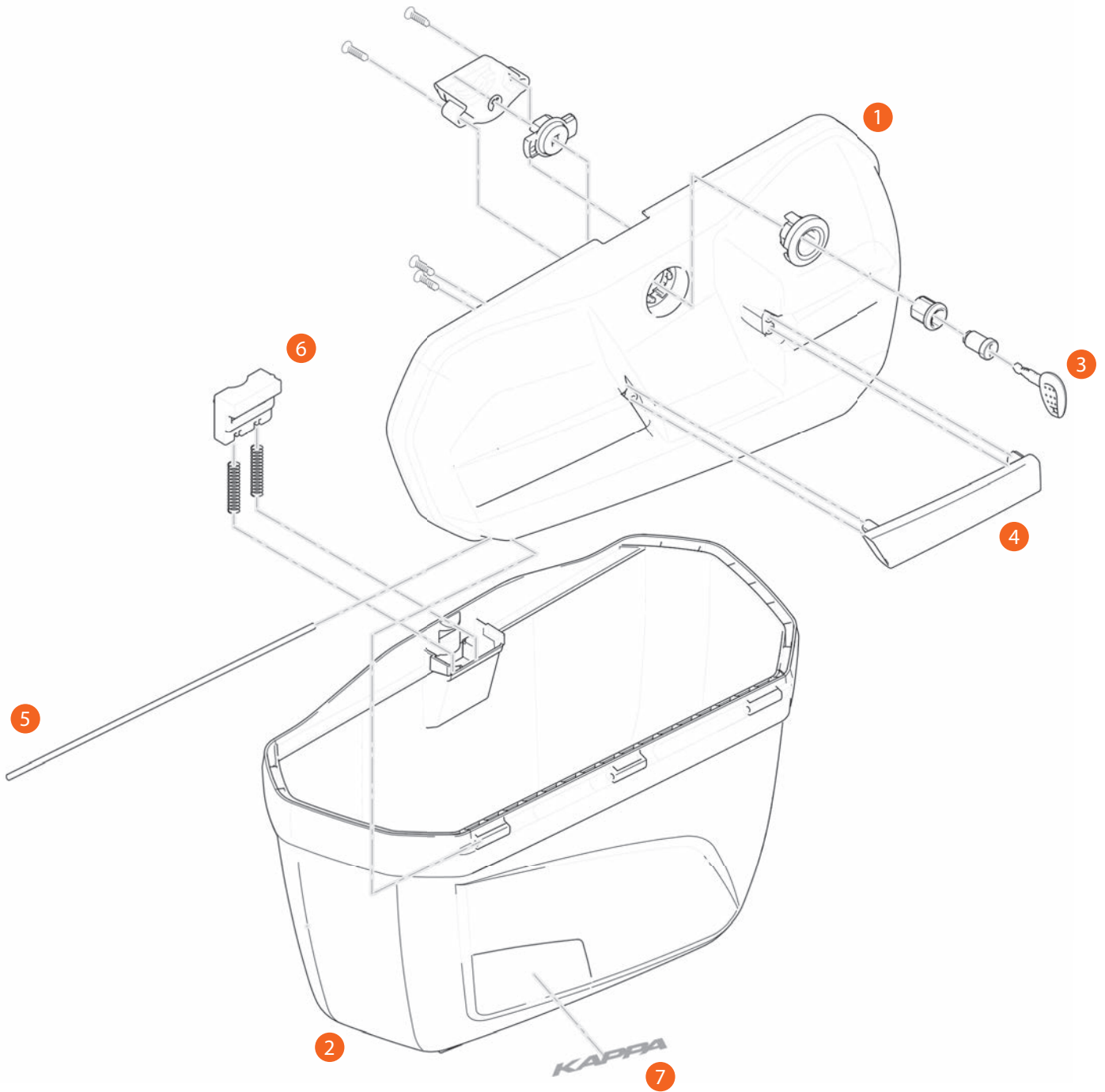

1	<b>Z22CNDXMK</b>	K22 assembled top-shell (right)		
1	<b>Z22CNSXMK</b>	K22 assembled top-shell (left)		
2	<b>KZ22FNDXM</b>	K22 assembled bottom-shell (right)		
2	<b>KZ22FNSXM</b>	K22 assembled bottom-shell (left)		
3	<b>Z4023RK</b>	Key locks with corresponding bush for K22		

4	<b>Z4020RK</b>	Pair of handles for K22		
5	<b>ZS310RK</b>	Pin. Medium, for K22		
6	<b>Z4025RK</b>	Bolt with springs for K22		
7	<b>KZ22R</b>	Logo sticker for K22, 2 pcs.		



# K33N

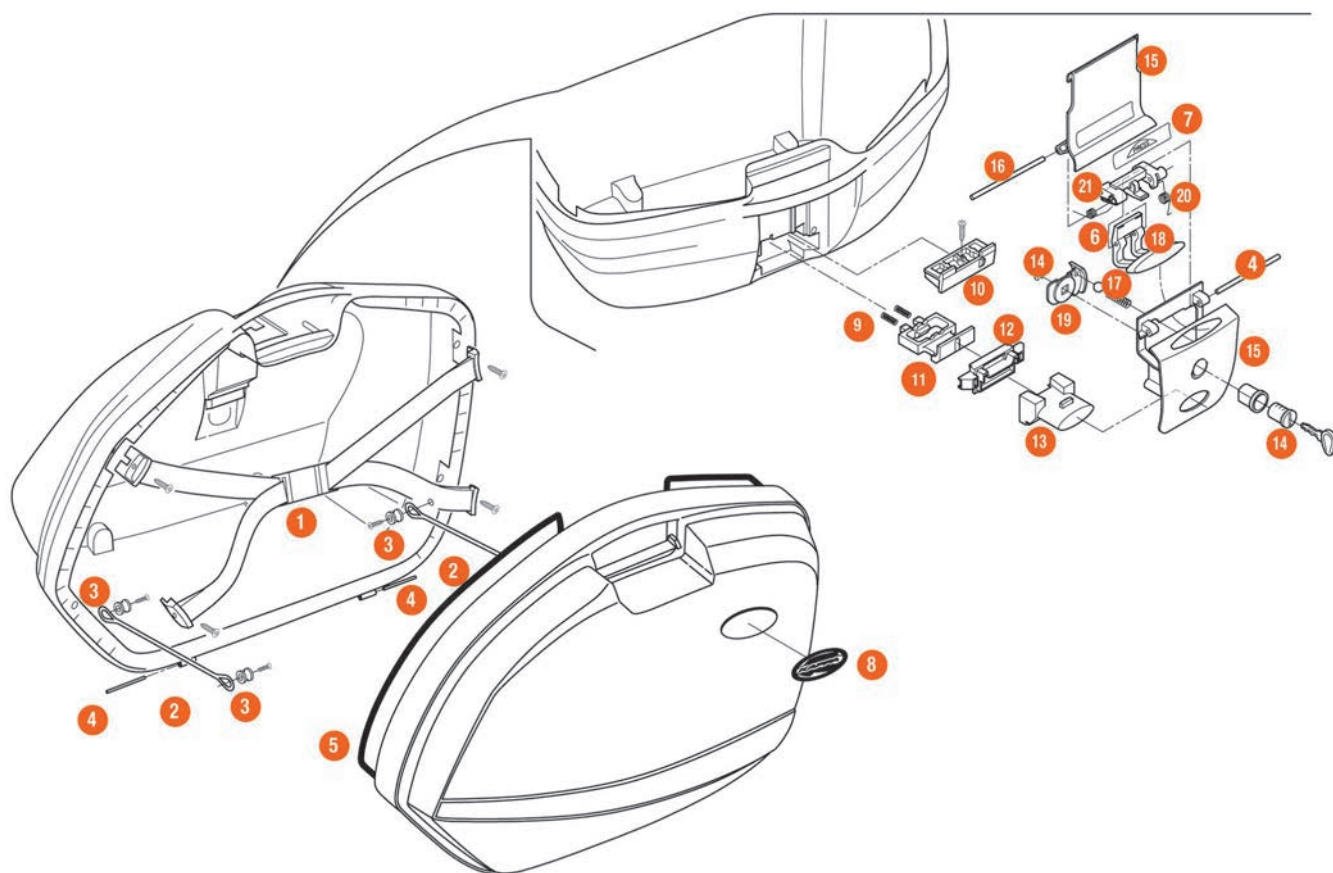

1	<b>Z1547R</b>	Inner elastic belt, 1 pcs.		
2	<b>Z115RK</b>	Stop bag opening yarn, 2 pcs.		
3	<b>Z112RK</b>	Red pulley, 4 pcs.		
4	<b>Z637RK</b>	Pin. D. 04x75 mm, (1 piece)		
5	<b>Z769K</b>	Rubber seal		
6	<b>Z632RK</b>	Steel torsion spring		
7	<b>Z409RK</b>	Name holder, 1 pcs.		
8	<b>Z1632R</b>	Oval KAPPA Logo, in aluminium, 1 pcs.		
9	<b>Z109K</b>	Long bolt springs		
10	<b>Z1404RK</b>	Push button guide 1pcs.		
11	<b>Z106K</b>	Bolt		
13	<b>Z645RK</b>	Push button red, 1 pcs.		
14	<b>K500</b>	Lock key, 1 kit		
15	<b>Z641NRK</b>	Hinge black		

16	<b>Z721RK</b>	Pin. D. 04x85 mm		
17	<b>Z1384RK</b>	Cylinder spring and steel spheres, 1 kit		
18	<b>Z644RK</b>	Opening push button, 1 pcs.		
19	<b>Z640RK</b>	Plate below lock, 1 pcs.		
20	<b>Z647RK</b>	Torsion spring, 1 pcs.		
21	<b>Z643RK</b>	Lock set element red, 1 pcs.		
	<b>ZK33FNDX</b>	Right bottom-shell (mounted)		
	<b>ZK33FNSX</b>	Left bottom-shell (mounted)		
	<b>ZK33CNDX</b>	Right top-shell (mounted)		
	<b>ZK33CNSX</b>	Left top-shell (mounted)		
	<b>Z641NMK</b>	Hinge complete		
	<b>K33NDX</b>	Right side		
	<b>K33NSX</b>	Left side		
	<b>Z1387RK</b>	Pair of rotational rear clamps		

# K47 MANTA / K47 MANTA TECH / K47B MANTA / K47NN MANTA

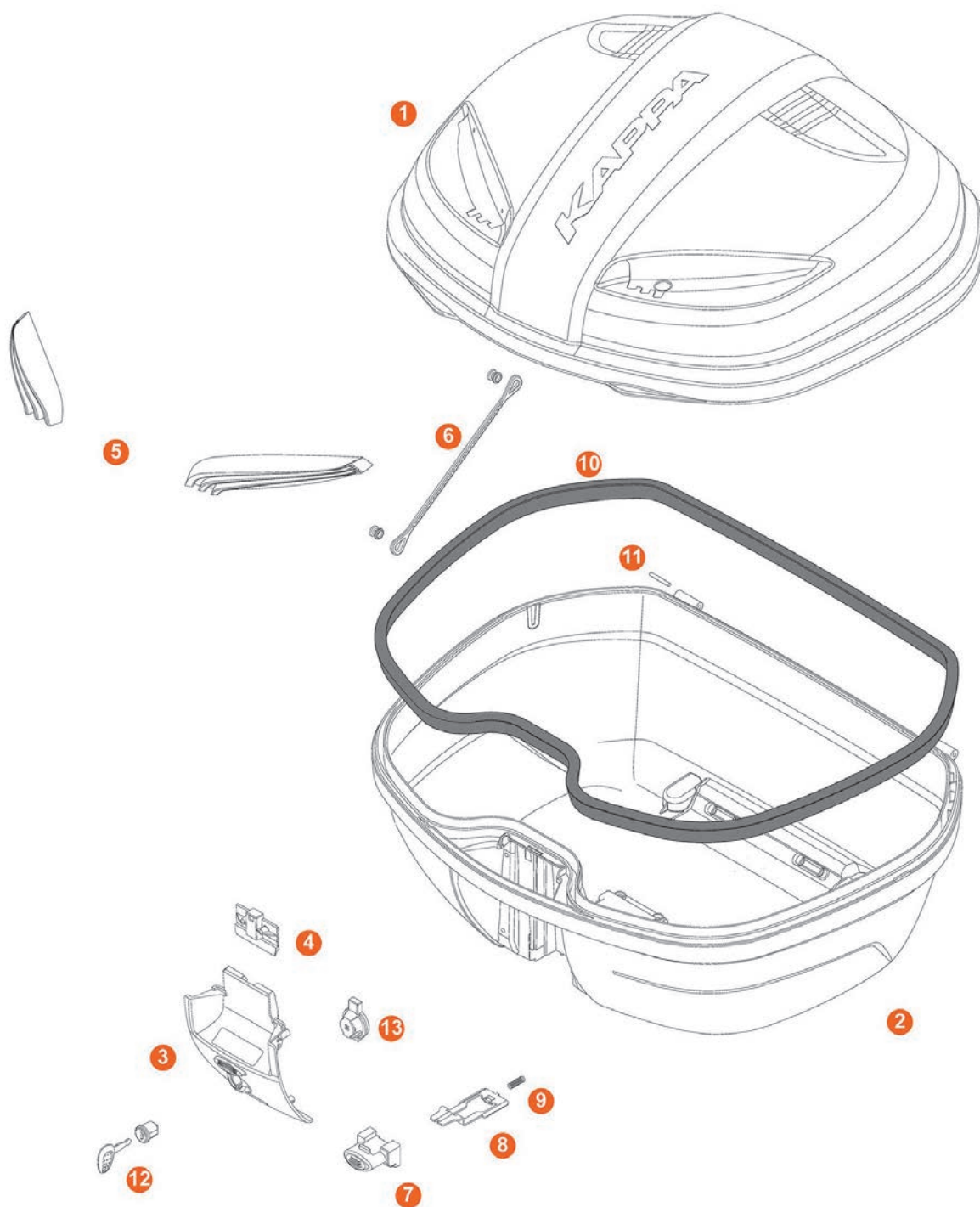

1	<b>ZK47CNM</b>	Mounted top-shell			6	<b>Z599K</b>	Stop bag opening yarn 188mm		
1	<b>ZK47CNNM</b>	Mounted top-shell K47NN			7	<b>Z1983RK</b>	Push button, red		
1	<b>ZK47CNTM</b>	Mounted top-shell				<b>Z645CRK</b>	Push button chromed (NT/ B version)		
2	<b>ZK47FNM</b>	Mounted bottom-shell			8	<b>Z761NRK</b>	Bolt, 1 pcs.		
2	<b>ZK47FNTM</b>	Mounted bottom-shell			9	<b>Z191RK</b>	Push button spring, 1 pcs.		
3	<b>ZK3007NM</b>	Hinge, complete			10	<b>Z790RK</b>	Rubber seal		
3	<b>ZK3007NTM</b>	Hinge, complete (NT/ B version)			11	<b>Z590RK</b>	Pin. Medium, 2 pcs.		
4	<b>Z3012RK</b>	Lock key system for top-shell			12	<b>Z156K</b>	Key lock complete of bushing and black cap		
5	<b>Z470R</b>	Top-case reflector, red				<b>K500N</b>	Lock key black, 1 kit (NT/ B version)		
5	<b>Z470FR</b>	Smoked op-case reflector (NT/ B version)			13	<b>Z3006RK</b>	Below lock, red		

# K400 / K400 TECH

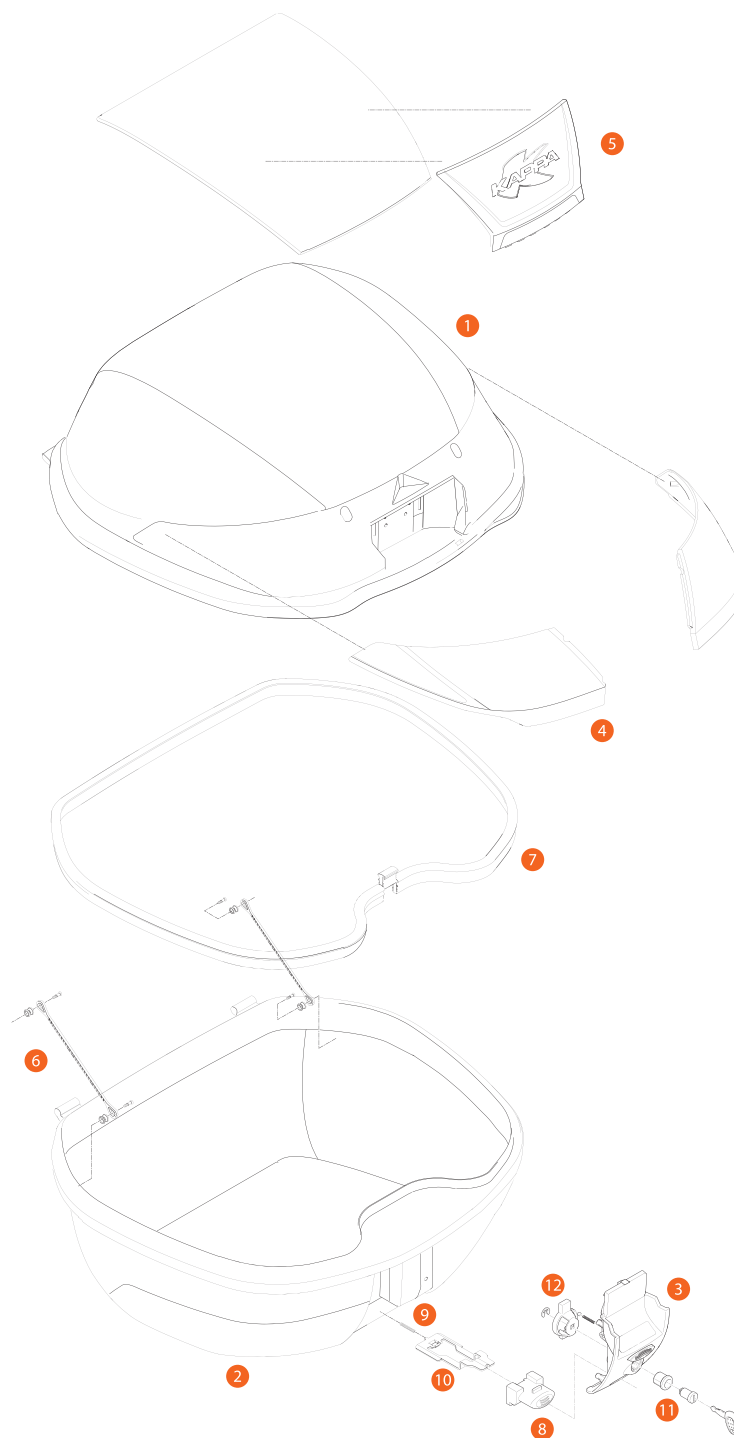

1	<b>K400CNM</b>	Assembled top-shell, black		
1	<b>K400CNTM</b>	Assembled top-shell (version NT)		
2	<b>ZK37FNM</b>	Mounted bottom-shell (N/NN version)		
2	<b>ZK37FNTM</b>	Mounted bottom-shell (NT version)		
3	<b>ZK3007NM</b>	Hinge, complete		
3	<b>ZK3007NTM</b>	Hinge, complete (NT version)		
4	<b>K401R</b>	Red reflectors		
4	<b>K401FR</b>	Smoked reflectors		
5	<b>K402G7880PR</b>	Central plate		
	<b>Z3012RK</b>	Lock key system for top-shell		

6	<b>Z599K</b>	Stop bag opening yarn 188mm		
7	<b>Z790RK</b>	Rubber seal		
8	<b>Z1983RK</b>	Push button, red		
8	<b>Z645CRK</b>	Push button (NT version)		
9	<b>Z191RK</b>	Push button spring, 1 pcs.		
10	<b>Z761NRK</b>	Bolt, 1 pcs.		
11	<b>Z156K</b>	Key lock complete of bushing and black cap		
11	<b>K500N</b>	Lock key black, 1 kit		
12	<b>Z3006RK</b>	Below lock, red		

## K46 / K46 TECH



1	<b>K46CNM</b>	Top-shell, black (mounted)		
1	<b>K46CNTM</b>	Mounted top-shell (NT version)		
2	<b>Z450FNMK</b>	Bottom-shell, black (mounted)		
2	<b>Z450FNTMK</b>	Mounted bottom-shell (NT version)		
3	<b>Z1632R</b>	Oval KAPPA Logo, in aluminium, 1 pcs.		
4	<b>Z115RK</b>	Stop bag opening yarn, 2 pcs.		
5	<b>Z112RK</b>	Red pulley, 4 pcs.		
7	<b>Z114K</b>	Cover plate for Z113		
8	<b>Z159RK</b>	Bag lock lining, 1 pcs.		
9	<b>Z590RK</b>	Pin. Medium, 2 pcs.		
10	<b>Z191RK</b>	Push button spring, 1 pcs.		
11	<b>Z629DX</b>	Reflector (right)		
11	<b>Z629SX</b>	Reflector (left)		
	<b>Z629TRK</b>	Pair of side reflectors (NT version)		
12	<b>Z642</b>	Central reflector for K46		
12	<b>Z642FR</b>	Central reflector (NT version)		
13	<b>Z846K</b>	Circuit covering cap, 1 pcs.		
14	<b>Z873K</b>	Antitheft hole black cover		
15	<b>Z665</b>	Logo for reflector (Z642)		

16	<b>Z409RK</b>	Name holder, 1 pcs.		
18	<b>Z632RK</b>	Steel torsion spring		
19	<b>Z637RK</b>	Pin. D. 04x75 mm, (1 piece)		
20	<b>Z210K</b>	Chrome bushing for lock set		
21	<b>Z640RK</b>	Plate below lock, 1 pcs.		
22	<b>Z641NRK</b>	Hinge black		
	<b>Z641NMK</b>	Hinge complete		
	<b>Z641NNM</b>	Complete hinge (NT version)		
23	<b>Z643RK</b>	Lock set element red, 1 pcs.		
24	<b>Z644RK</b>	Opening push button, 1 pcs.		
24	<b>Z644NRK</b>	Opening push button (NT version)		
25	<b>Z645RK</b>	Push button red, 1 pcs.		
26	<b>Z647RK</b>	Torsion spring, 1 pcs.		
28	<b>Z721RK</b>	Pin. D. 04x85 mm		
29	<b>Z762NRK</b>	Bolt, 1 pcs.		
30	<b>K500</b>	Lock key, 1 kit		
	<b>Z156NK</b>	Key lock complete of bushing and black cap (NT version)		
31	<b>Z126K</b>	Plate rubber Monorack/Wingrack		
32	<b>Z658</b>	Reflector bottom for Z629		

## K466 URBAN / K466 URBAN TECH

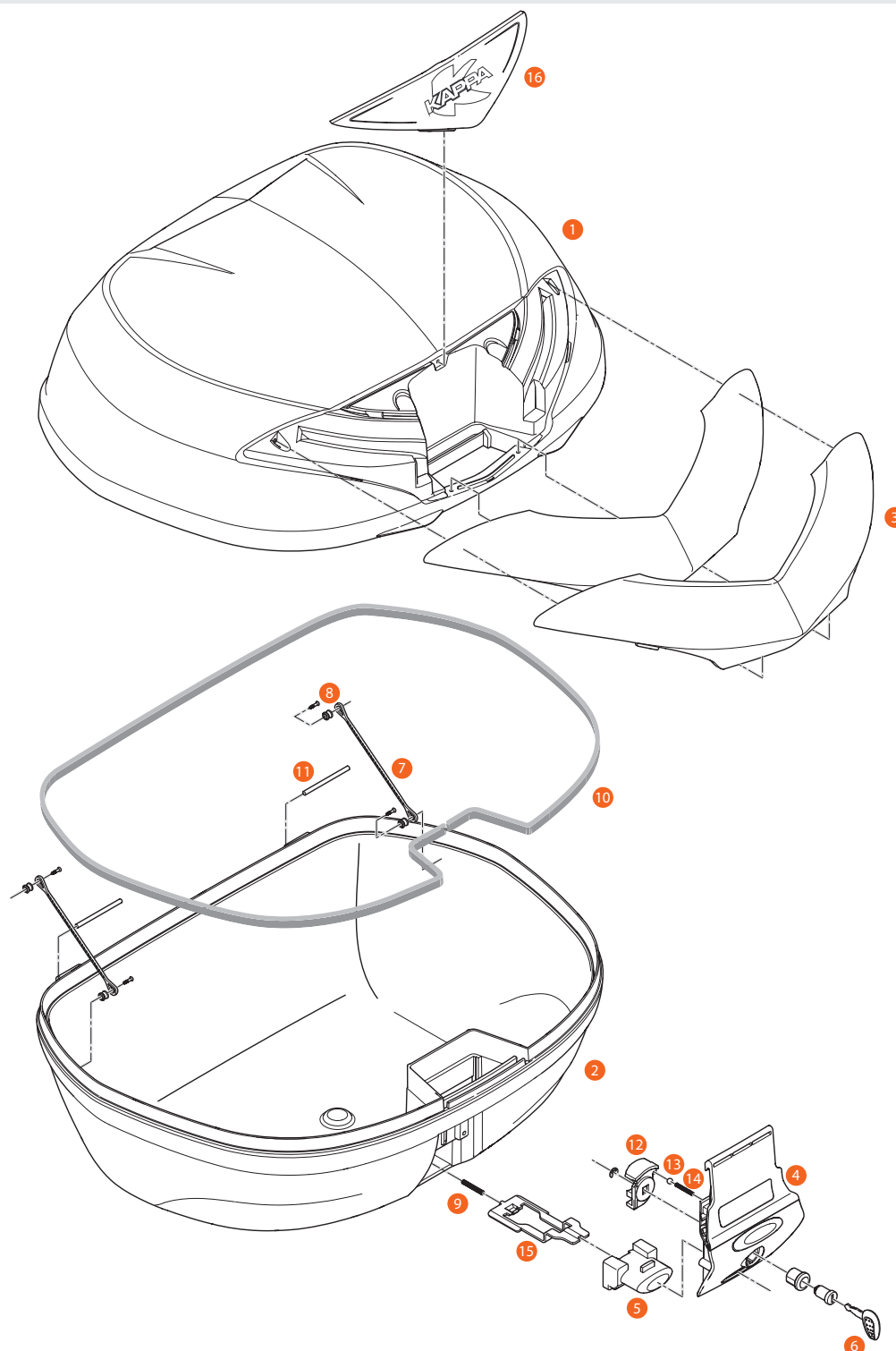

1	<b>ZK461CNM</b>	K466N assembled Top Shell black		
1	<b>ZK461CNMT</b>	Assembled Top Shell (version NT)		
2	<b>Z50FNMK</b>	Bottom-shell, black (mounted)		
2	<b>Z450FNTMK</b>	Mounted bottom-shell (NT version)		
3	<b>Z4613R</b>	K466N top-case reflector, red		
3	<b>Z4613FR</b>	Smoked reflector (version NT)		
4	<b>Z641NMK</b>	Hinge complete		
4	<b>Z641NNM</b>	Complete hinge (NT version)		
5	<b>Z1983RK</b>	Push button, red		
6	<b>K500</b>	Lock key, 1 kit		

	<b>Z156NK</b>	Key lock complete of bushing and black cap (NT version)		
7	<b>Z115RK</b>	Stop bag opening yarn, 2 pcs.		
8	<b>Z112RK</b>	Red pulley, 4 pcs.		
9	<b>Z191RK</b>	Push button spring, 1 pcs.		
10	<b>Z159RK</b>	Bag lock lining, 1 pcs.		
11	<b>Z590RK</b>	Pin, Medium, 2 pcs.		
12	<b>Z640RK</b>	Plate below lock, 1 pcs.		
13	<b>Z630K</b>	Steel spheres D. 6		
15	<b>Z762NRK</b>	Bolt, 1 pcs.		
16	<b>Z4614A900R</b>	K466 embossed logo plate		

# K37 MANTA / K37 MANTA TECH / K37NN MANTA

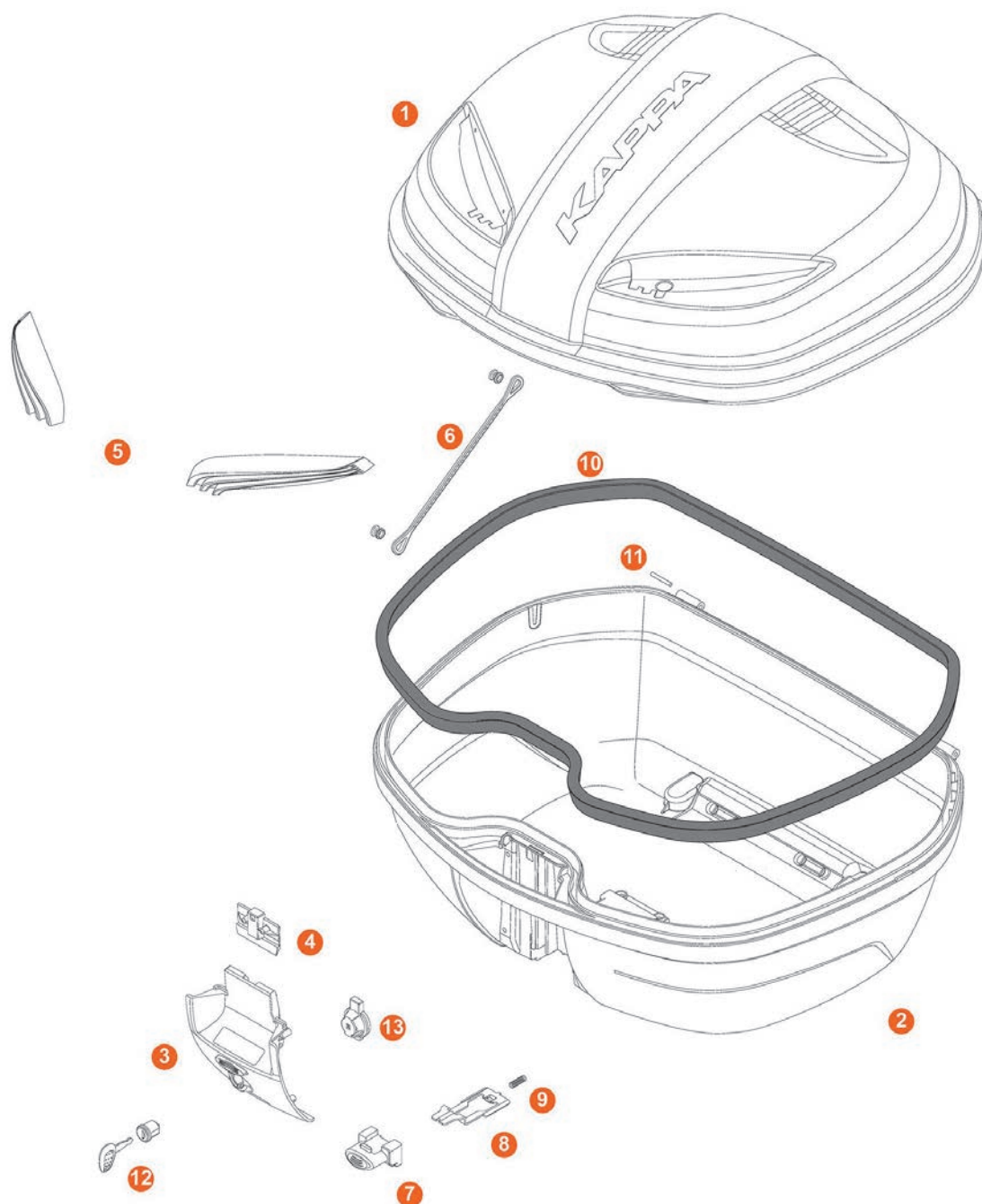

1	<b>ZK37CNNM</b>	Mounted top-shell (NN version)		
1	<b>ZK37CNM</b>	Mounted top-shell (N version)		
1	<b>ZK37CNTM</b>	Mounted top-shell (NT version)		
2	<b>ZK37FNM</b>	Mounted bottom-shell (N/NN version)		
2	<b>ZK37FNTM</b>	Mounted bottom-shell (NT version)		
3	<b>ZK3007NM</b>	Hinge, complete		
3	<b>ZK3007NTM</b>	Hinge, complete (NT version)		
4	<b>Z3012RK</b>	Lock key system for top-shell		
5	<b>Z470R</b>	Top-case reflector, red		
5	<b>Z470FR</b>	Smoked top-case reflector		
6	<b>Z599K</b>	Stop bag opening yarn 188mm		

7	<b>Z1983RK</b>	Push button, red for K37N / K37NN		
7	<b>Z645CRK</b>	Push button crhomed for K37NT		
8	<b>Z761NRK</b>	Bolt, 1 pcs.		
9	<b>Z191RK</b>	Push button spring, 1 pcs.		
10	<b>Z790RK</b>	Rubber seal		
11	<b>Z590RK</b>	Pin. Medium, 2 pcs.		
12	<b>Z156K</b>	Key lock complete of bushing and black cap for K37N/K37NN		
12	<b>K500N</b>	Lock key black for K37NT, 1 kit		
13	<b>Z3006RK</b>	Below lock, red for K37N/K37NN		

# K355 / K355 TECH

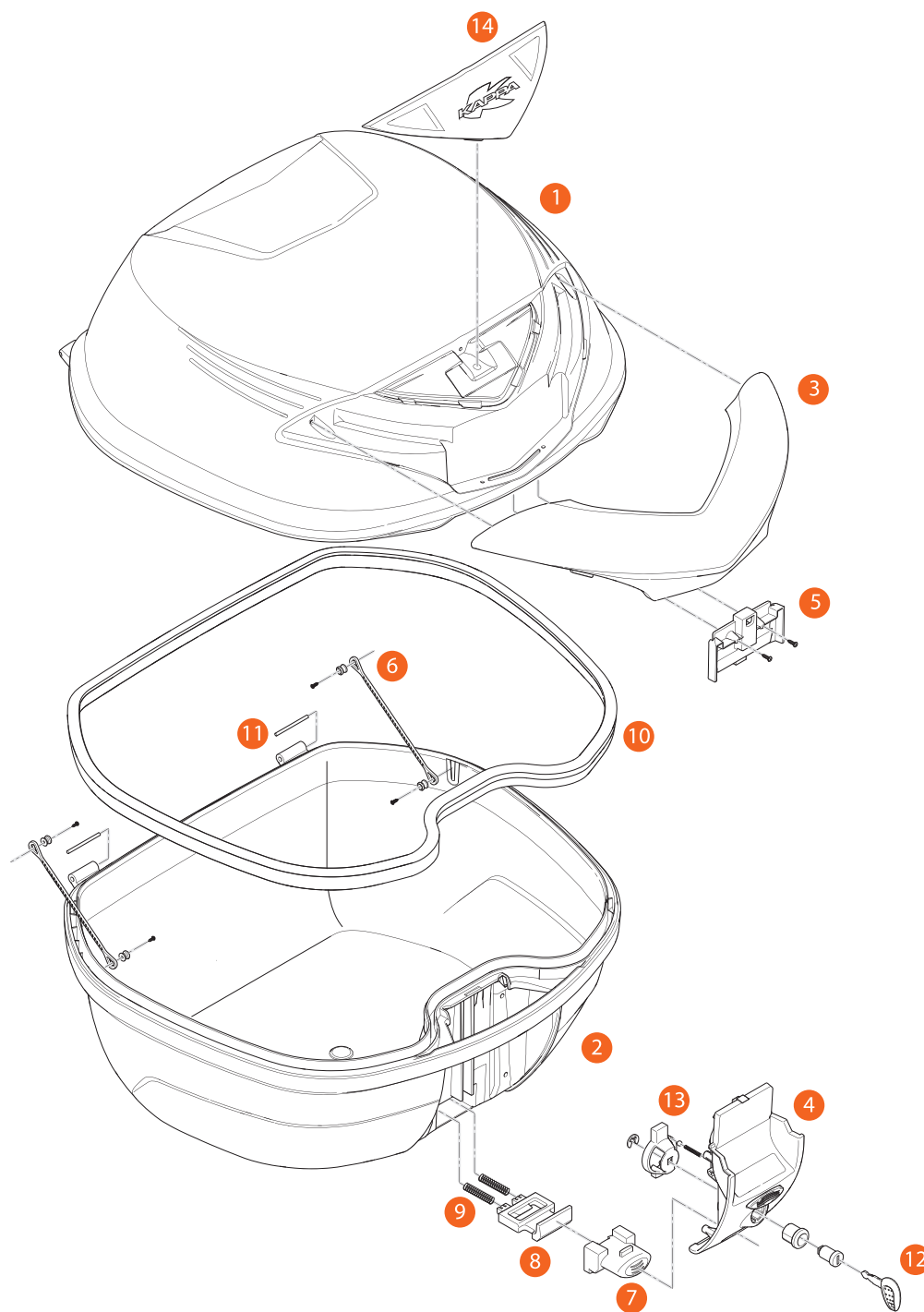

1	<b>K355CNM</b>	K355N assembled Top Shell		
1	<b>K355CNTM</b>	K355NT assembled Top Shell		
2	<b>ZK37FNM</b>	Mounted bottom-shell (N/NN version)		
2	<b>ZK37FNTM</b>	Mounted bottom-shell (NT version)		
3	<b>Z3555R</b>	Red reflector for K355N		
3	<b>Z3555FR</b>	Smoked reflector for K355NT		
4	<b>ZK3007NM</b>	Hinge, complete		
4	<b>ZK3007NTM</b>	Hinge, complete (NT version)		
5	<b>Z3012RK</b>	Lock key system for top-shell		
6	<b>Z599K</b>	Stop bag opening yarn 188mm		

7	<b>Z1983RK</b>	Push button, red		
8	<b>Z761NRK</b>	Bolt, 1 pcs.		
9	<b>Z191RK</b>	Push button spring, 1 pcs.		
10	<b>Z790RK</b>	Rubber seal		
11	<b>Z590RK</b>	Pin, Medium, 2 pcs.		
12	<b>Z156K</b>	Key lock complete of bushing and black cap		
	<b>K500N</b>	Lock key black, 1 kit (NT version)		
13	<b>Z3006RK</b>	Below lock, red		
14	<b>Z3556R</b>	K355 embossed logo plate		

## K35 / K35BMAL / K35 TECH



1	<b>K35CNM</b>	Top-shell, black (mounted)		
1	<b>K35CNTM</b>	Mounted top-shell (NT version)		
2	<b>Z350FNMK</b>	Bottom-shell, black (mounted)		
2	<b>Z350FNTMK</b>	Mounted bottom-shell (NT version)		
3	<b>Z726-K</b>	Black lock lining		
4	<b>Z191RK</b>	Push button spring, 1 pcs.		
5	<b>Z210K</b>	Chrome bushing for lock set		
6	<b>Z1632PVCR</b>	Oval KAPPA Logo, PVC		
7	<b>Z409RK</b>	Name holder, 1 pcs.		
8	<b>K571</b>	Sticker set (dx sx)		
9	<b>K626DX</b>	Reflector (right)		
9	<b>K626SX</b>	Reflector (left)		
	<b>K626TR</b>	Pair of transparent reflectors (NT version)		
10	<b>Z112RK</b>	Red pulley, 4 pcs.		
12	<b>Z114K</b>	Cover plate for Z113		
13	<b>Z115RK</b>	Stop bag opening yarn, 2 pcs.		
15	<b>Z632RK</b>	Steel torsion spring		
16	<b>Z635RK</b>	Pin. D. 04x48 mm, 2 pcs.		
17	<b>Z637RK</b>	Pin. D. 04x75 mm, (1 piece)		

18	<b>Z640RK</b>	Plate below lock, 1 pcs.		
19	<b>Z641NRK</b>	Hinge black		
19	<b>Z641NMK</b>	Hinge complete		
	<b>Z641NNM</b>	Complete hinge (NT version)		
20	<b>Z643RK</b>	Lock set element red, 1 pcs.		
21	<b>Z644RK</b>	Opening push button, 1 pcs.		
	<b>Z644NRK</b>	Opening push button (NT version)		
22	<b>Z645RK</b>	Push button red, 1 pcs.		
23	<b>Z647RK</b>	Torsion spring, 1 pcs.		
25	<b>Z721RK</b>	Pin. D. 04x85 mm		
26	<b>Z761NRK</b>	Bolt, 1 pcs.		
27	<b>Z873K</b>	Antitheft hole black cover		
28	<b>Z929S</b>	Front KAPPA Logo (Silk screen printed)		
28	<b>Z929NR</b>	Front logo, Silk screen printed (NT version)		
29	<b>626KA</b>	White sticher for K626		
30	<b>K500</b>	Lock key, 1 kit		
	<b>Z156NK</b>	Key lock complete of bushing and black cap (NT version)		
31	<b>Z126K</b>	Plate rubber Monorack/Wingrack		



## → K30 / K30B / K30 TECH



1	<b>ZK30CNM</b>	Top-shell, black (mounted)		
1	<b>ZK30CNTM</b>	Assembled top-shell (version NT)		
2	<b>ZK30FNM</b>	Bottom-shell, black (mounted)		
2	<b>ZK30FBM</b>	Mounted bottom-shell (B version)		
3	<b>Z1724R</b>	Reflector with white background		
3	<b>Z1724FR</b>	Smoked reflector (NT/B version)		
4	<b>Z1632R</b>	Oval KAPPA Logo, in aluminium, 1 pcs.		
5	<b>Z314NM2K</b>	Hinge, complete black		
	<b>Z314NTMK</b>	Mounted lock set (version NT)		

	<b>Z314NNM</b>	Complete hinge (B version)		
6	<b>Z191RK</b>	Push button spring, 1 pcs.		
7	<b>Z193K</b>	Hinge pin 62 mm		
8	<b>Z310K</b>	Bolt		
9	<b>Z315K</b>	Push button		
9	<b>Z315NRK</b>	Push button (B version)		
10	<b>K500</b>	Lock key, 1 kit		
	<b>Z156K</b>	Key lock complete of bushing and black cap		
13	<b>Z114K</b> ↘	Cover plate for Z113		

## → K42



4	<b>Z195K</b>	Pin D. 04x80 mm		
5	<b>Z210K</b>	Chrome bushing for lock set		
6	<b>Z312K</b>	Hinge plate		
7	<b>Z314NK</b>	Hinge black		
7	<b>Z314NM2K</b>	Hinge, complete black		
8	<b>Z873K</b>	Anti-theft hole black cover		
9	<b>K546</b>	Name-Address holder		
10	<b>Z315K</b>	Push button		
11	<b>Z310K</b>	Bolt		

	<b>Z191RK</b>	Push button spring, 1 pcs.		
13	<b>Z243K</b>	Key lock plate		
	<b>Z114K</b> ↘	Cover plate for Z113		
18	<b>Z590RK</b>	Pin, Medium, 2 pcs.		
19	<b>K500</b>	Lock key, 1 kit		
20	<b>K619B</b>	White stickers set for K42		
20	<b>K619N</b>	Black stickers set for K42		
	<b>Z126K</b>	Plate rubber Monorack/Wingrack		

## K28



3	<b>Z159RK</b>	Bag lock lining, 1 pcs.		
4	<b>Z191RK</b>	Push button spring, 1 pcs.		
5	<b>Z195K</b>	Pin D. 04x80 mm		
6	<b>Z193K</b>	Hinge pin 62 mm		
7	<b>Z210K</b>	Chrome bushing for lock set		
8	<b>Z315K</b>	Push button		
9	<b>Z312K</b>	Hinge plate		
10	<b>Z310K</b>	Bolt		
11	<b>Z243K</b>	Key lock plate		

12	<b>Z314NK</b>	Hinge black		
12	<b>Z314NM2K</b>	Hinge, complete black		
13	<b>K546</b>	Name-Address holder		
14	<b>Z1632R</b>	Oval KAPPA Logo, in aluminium, 1 pcs.		
17	<b>Z114K</b>	Cover plate for Z113		
19	<b>Z873K</b>	Antitheft hole black cover		
20	<b>Z843</b>	White sticker for K617		
21	<b>K500</b>	Lock key, 1 kit		
23	<b>Z126K</b>	Plate rubber Monorack/Wingrack		

## K26



1	<b>K26CNM</b>	Top-shell, black (mounted)		
3	<b>Z1632PVCR</b>	Oval KAPPA Logo, PVC		
4	<b>Z112RK</b>	Red pulley, 4 pcs.		
6	<b>Z114K</b>	Cover plate for Z113		
7	<b>Z115RK</b>	Stop bag opening yarn, 2 pcs.		
8	<b>Z191RK</b>	Push button spring, 1 pcs.		
9	<b>Z210K</b>	Chrome bushing for lock set		
10	<b>Z310K</b>	Bolt		
11	<b>Z409RK</b>	Name holder, 1 pcs.		
13	<b>Z632RK</b>	Steel torsion spring		
14	<b>Z635RK</b>	Pin. D. 04x48 mm, 2 pcs.		
15	<b>Z637RK</b>	Pin. D. 04x75 mm, (1 piece)		

16	<b>Z640RK</b>	Plate below lock, 1 pcs.		
17	<b>Z641NRK</b>	Hinge black		
	<b>Z641NMK</b>	Hinge complete		
18	<b>Z643RK</b>	Lock set element red, 1 pcs.		
19	<b>Z644RK</b>	Opening push button, 1 pcs.		
20	<b>Z645RK</b>	Push button red, 1 pcs.		
21	<b>Z647RK</b>	Torsion spring, 1 pcs.		
23	<b>Z721RK</b>	Pin. D. 04x85 mm		
24	<b>Z873K</b>	Antitheft hole black cover		
26	<b>K500</b>	Lock key, 1 kit		
27	<b>Z929SK26</b>	Front KAPPA Logo (Silk screen printed)		
29	<b>Z126K</b>	Plate rubber Monorack/Wingrack		

# K28BAS

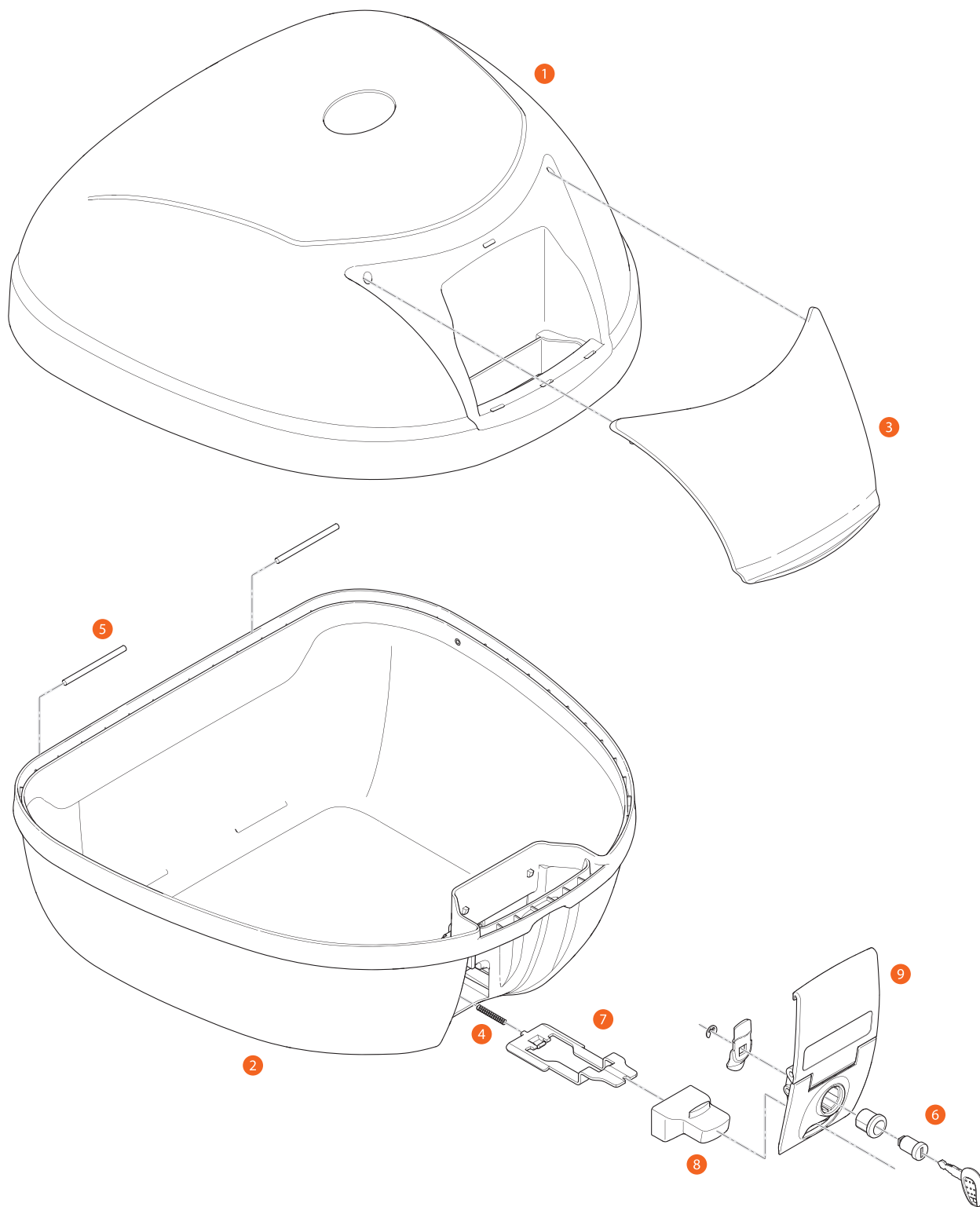

2	<b>ZK28BASFNM</b>	Bottom-shell, black (mounted)		
3	<b>Z3761R</b>	Reflector for K28BAS		
	<b>Z159RK</b>	Bag lock lining, 1 pcs.		
4	<b>Z191RK</b>	Push button spring, 1 pcs.		
5	<b>Z193K</b>	Hinge pin 62 mm		

6	<b>Z210K</b>	Chrome bushing for lock set		
7	<b>Z310K</b>	Bolt		
8	<b>Z315K</b>	Push button		
9	<b>Z314NM2K</b>	Hinge, complete black		

# KCY14N - BIKE BOX

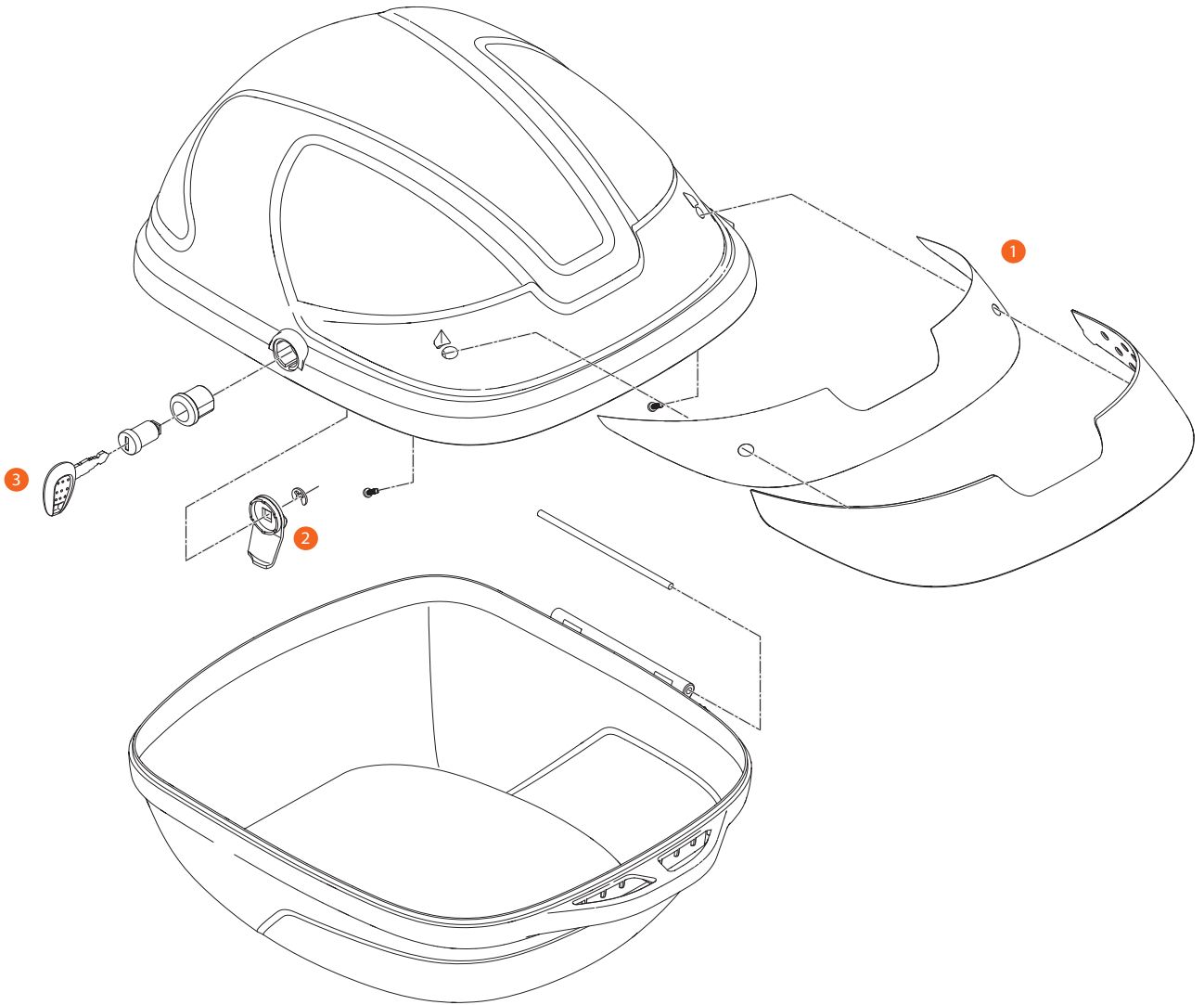

→ PLATES AND SPARE PARTS

1	<b>KZ3101TR</b>	Reflector for KCY14N			
2	<b>Z3102RK</b>	Below lock KCY14N			
3	<b>K500</b>	Lock key, 1 kit			

## KCY25N - BIKE BOX

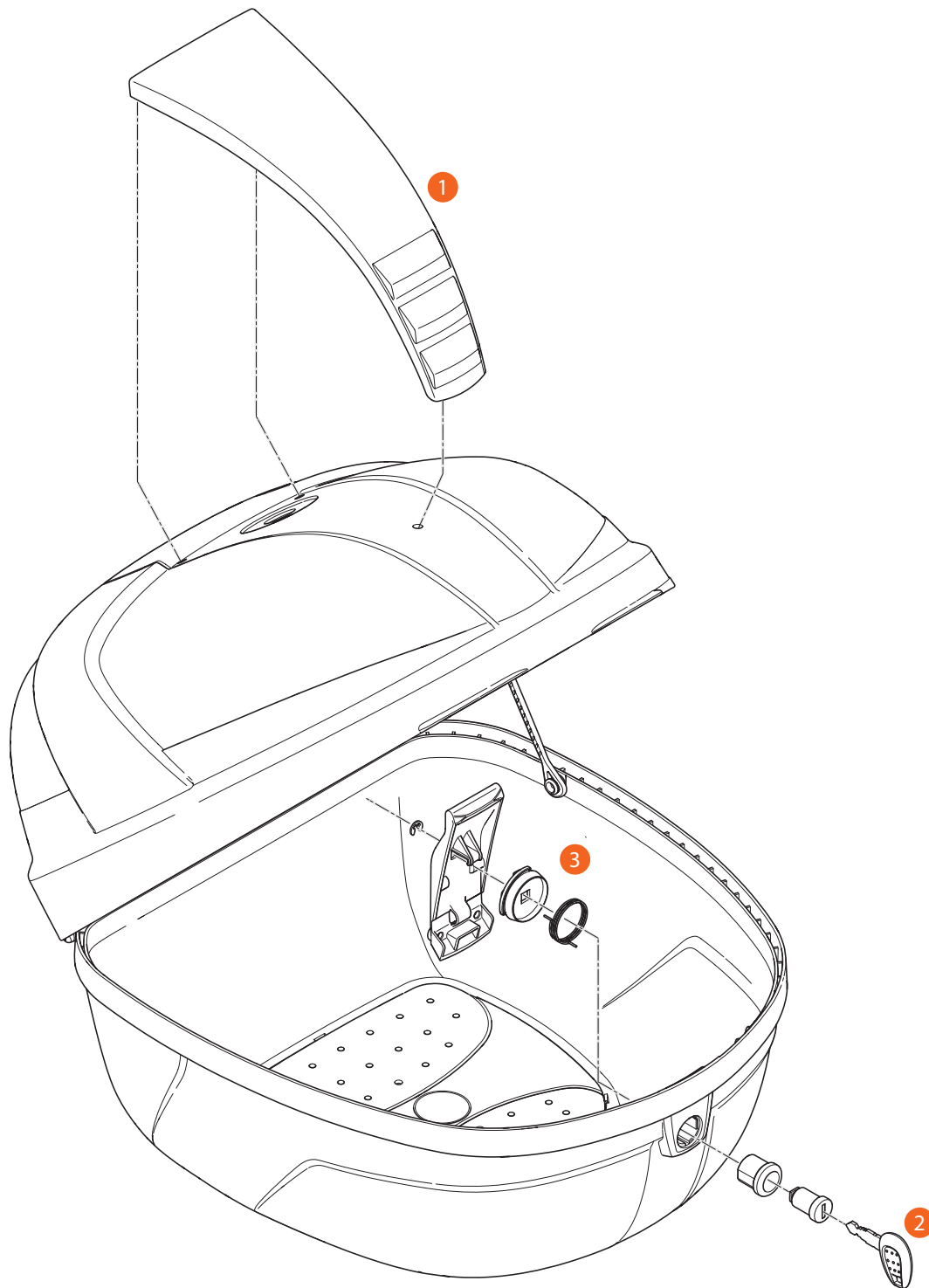

1	<b>KZ1730TR</b>	Reflector with graphics for KCY25N		
2	<b>Z1734RK</b>	Locking system, complete		

3	<b>K500</b>	Lock key, 1 kit		
---	-------------	-----------------	--	--

## → PLATES COMPONENTS



1	<b>Z890K</b>	1 joint set for Monorack 2/3/MKN			4	<b>Z896K</b>	1 set joint Monorack 35 mm		
2	<b>Z124K</b>	Bag case attachment clamps			5	<b>Z128K</b>	Complete kit for plastic boss for Wingrack		
3	<b>Z125K</b>	Bag case attachment support hook spacer (2pcs)							

## → WINGRACK



1	<b>Z163DXK</b>	Wingrack 1 fin (right)			3	<b>Z145SXK</b>	Wingrack direction indicator (1 piece) (left)		
2	<b>Z163SXK</b>	Wingrack 1 fin (left)			4	<b>Z231K</b>	Direction indicator lens for Z145		
3	<b>Z145DXK</b>	Wingrack direction indicator (1 piece) (right)							

## → KL / KLR



1	<b>Z221K</b>	Rubber			4	<b>Z125K</b>	Bag case attachment support hook spacer (2pcs)		
2	<b>Z670K</b>	Screw cap for hook for side-case holder, 1 piece			5	<b>Z2711RK</b>	Replacement key for the tubular side-case holders with rapid fitting KLXR and KLR		
3	<b>Z124K</b>	Bag case attachment clamps							

## → PLATES



1	<b>Z622MK</b>	Nylon plate for MONOKEY® cases		
2	<b>Z667MK</b>	Nylon plate for MONOLOCK® cases		
3	<b>Z340K</b>	Aluminium plate for MONOLOCK® cases		
4	<b>Z255K</b>	Nylon plate for MONOKEY® cases		
5	<b>Z4400RK</b>	Universal MONOKEY® plate		
6	<b>Z4401KR</b>	Cover Plate for universal MONOKEY® plate		
8	<b>Z114K</b> ↘	Cover plate for Z113		

9	<b>Z2710K</b>	Plate rubber parts		
9	<b>Z2710AK</b>	Antivibration rubber grommets (with increased height – set of 4) for KM7/K636/KRA		
10	<b>Z621RK</b>	Hole covering caps		
11	<b>Z126K</b>	Plate rubber Monorack/Wingrack		
	<b>Z113-2K</b>	Spare plate for universal MONOLOCK® plate		

## → STOP LIGHT KIT



1	<b>Z1081K</b> ↘	Spare top-shell contact for stop light		
3	<b>Z880K</b>	Plate contact with wire for stoplight kit		
4	<b>Z995MK</b> ↘	Spare part between bottom-shell and plate		

	<b>Z2111RK</b>	The plate contact has a cable with 3 terminals (spare part for the devices with remote-controlled opening)		
	<b>Z2109RK</b>	The contact with the bottom-shell of the case has 3 terminals (spare part for the devices with remote-controlled opening)		

# AIRSTREAM SPARE PARTS

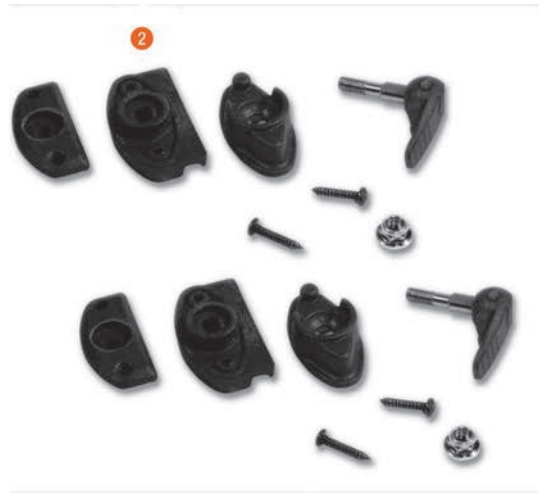

2	Z1963RK	Airstream guide latch spare parts		
---	---------	-----------------------------------	--	--



# → MOUNTING POSSIBILITIES

## MONOKEY® CASES RANGE



**KVE58\_**



**KVE48\_**



**KVE42\_**



**KVE37\_PACK2**



**KGR52\_**



**KGR46\_PACK2**



**KGR33\_PACK2**



**K56**



**K53N**



**K49**



**K48N**



**K40N**



**K22**

In order to fix a case or top-case on your motorcycle/scooter, KAPPA offers lots of possibilities, depending on the model of motorcycle you own. Herewith following you will find all the fitting possibilities; you can look at the table "Guide to the availability for motorcycle models" to see which is the best solution in your case.

### A - MOUNTING POSSIBILITIES ( 1 MONOKEY TOP-CASE )

#### MONORACK (K / K...L TYPE)



**K553N**  
**K553L**

+

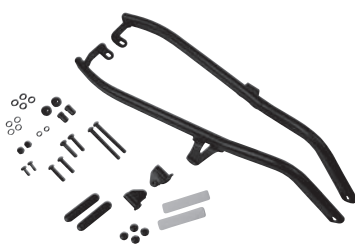

**K\_ \_ \_**  
**K\_ \_ \_ L**

=

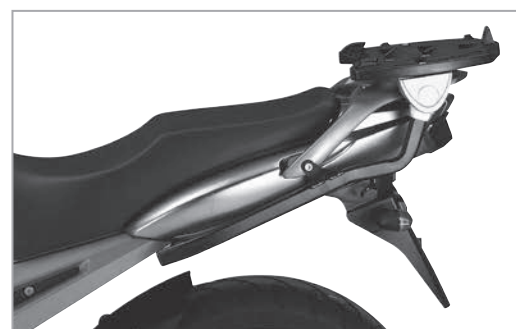

**MONORACK (KZ TYPE)**



KM5 / KM7

+



KZ\_ \_ \_

=



**SPECIAL RACK (KR TYPE)**



KR\_ \_ \_ - with the plate you find in the box  
- with K636



**SPECIFIC ALUMINIUMPLATE (KRA TYPE)**

For MONOKEY® cases



KRA\_ \_ \_

It does not allow the assembly of the stop light kit or the remote control device on the case

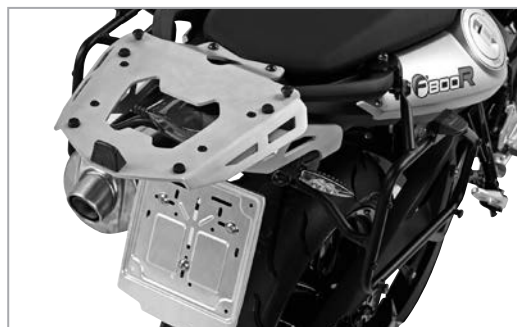

**SPECIFIC PLATE (K TYPE)**



K\_ \_ \_

with the plate you find in the box



## B - MOUNTING POSSIBILITIES ( 2 MONOKEY SIDE CASE )

Monokey® cases suggested by KAPPA for the lateral mounting: K21N - K22N - K40N

### SPECIFIC TUBULAR SIDE CASE HOLDER (KL TYPE)



KL \_\_\_  
or  
KLR \_\_\_ (Specific rapid attachment /release )

## MOUNTING POSSIBILITIES ( C - 3 MONOKEY® TOP-CASE ) ( D - 2 MONOKEY® TOP-CASE + 1 MONOLOCK® TOP-CASE )

Monokey® cases suggested by KAPPA for the lateral mounting: K21N - K22N - K40

### MONORACK (K/KZ/KL TYPE) + SPECIFIC TUBULAR SIDE CASE HOLDER (KL TYPE)

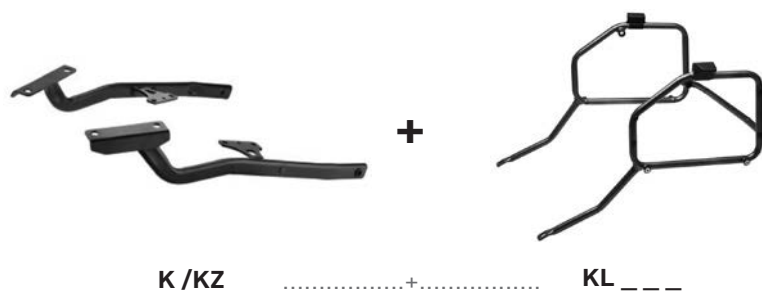

With KZ: + KM5 / KM11 plate for the mounting of Monokey® top-case / + KM5M plate for the mounting of the Monolock® top-case  
With K: + K553N for the mounting of Monokey® top-case / + MKN plate for the mounting of Monolock® top-case

### WINGRACK SYSTEM IN ALLUMINIUM (K140 /K141 TYPE)

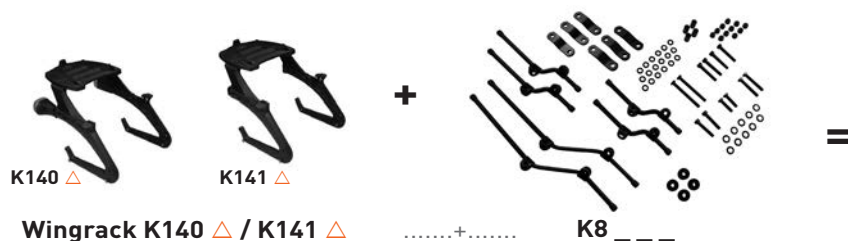

## MONOLOCK® CASES RANGE



K47



K466



K46



K400



K355



K35



K30



K29



K28



K28BAS



K26

### A - MOUNTING POSSIBILITIES (1 MONOLOCK® TOP-CASE )

#### MONORACK (K TYPE)



MKN

+

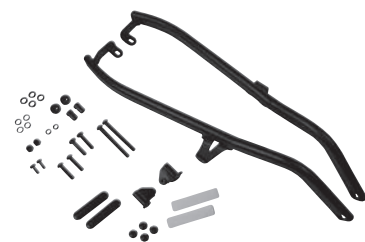

K\_ \_ \_

=



#### MONORACK (KZ TYPE)



KM6M/KM5M

+



KZ\_ \_ \_

=



#### SPECIFIC PLATE (KR TYPE)



KR \_ \_ \_ .....+.....  
KR \_ \_ \_ M .....+.....



with the Monolock® plate you find in the box  
with the plate you find in the box



**SPECIFIC PLATE (KE TYPE)**

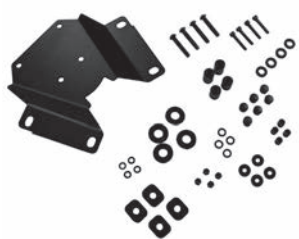

KE \_\_\_\_\_ + ..... with the Monolock® plate you find in the box



**MONOKEY® SIDE CASES RANGE**



**K33**

**MOUNTING POSSIBILITIES**  
(A - 2 MONOKEY® SIDE CASES)

(B - 2 MONOKEY® SIDE CASES + 1 MONOKEY® CASE OR 1 MONOLOCK® CASE)

**TUBULAR SIDE-CASE HOLDERS**  
(KLX)

**TUBULAR SIDE-CASE HOLDERS**  
RAPID FITTING (KLXR)



KLX \_\_\_\_\_ / KLXR \_\_\_\_\_

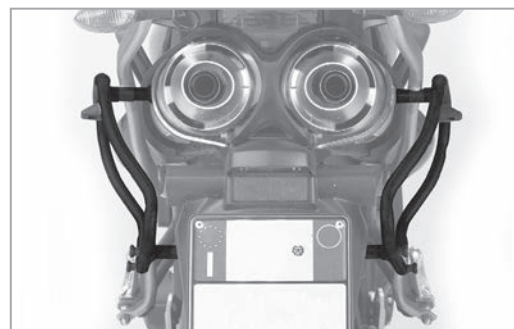

**MONORACK (K/KZ TYPE) + TUBULAR SIDE-CASE HOLDER (KLX/KLXR TYPE)**



**K / KZ**

+



\_\_\_\_\_ + ..... KLX \_\_\_\_\_ / KLXR \_\_\_\_\_

=



With KZ: + KM5 / KM7 plate for the mounting of Monokey® top-case / + KM5M plate for the mounting of Monolock® top-case  
With K: + K553N for the mounting of Monokey® top-case / + MKN plate for the mounting of Monolock® top-case

☑ = Item available until it runs out of stock  
△ = Discontinued items, only for illustration

# → MOUNTING POSSIBILITIES WITH UNIVERSAL SYSTEMS

If there has not been a specific solution for the mounting of KAPPA cases and top-cases for your motorcycle, you can also check the possibility of using one of the following universal fitting systems:

## A - MOUNTING POSSIBILITIES (1 MONOKEY® TOP-CASE)

UNIVERSAL MONORACK (K1200) / UNIVERSAL PLATE (K636)

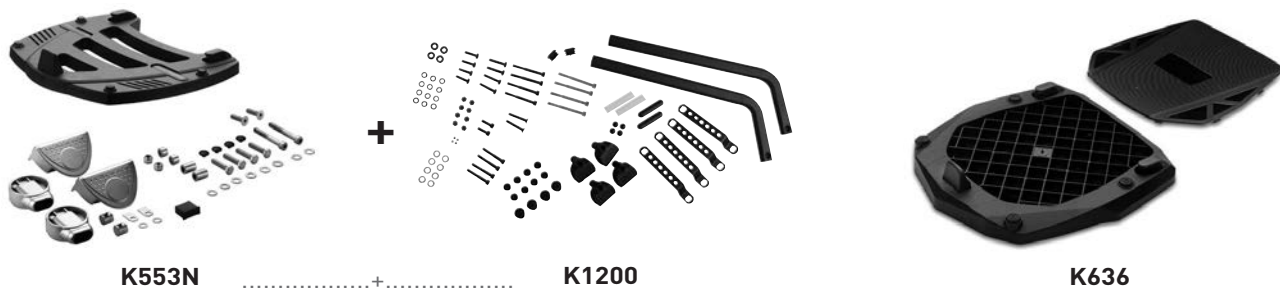

## B - MOUNTING POSSIBILITIES (3 MONOKEY® CASES)

UNIVERSAL FITTING KIT (K8127)



## C - MOUNTING POSSIBILITIES (1 MONOLOCK® CASE)

UNIVERSAL MONORACK (K1200) / UNIVERSAL PLATE (K636)

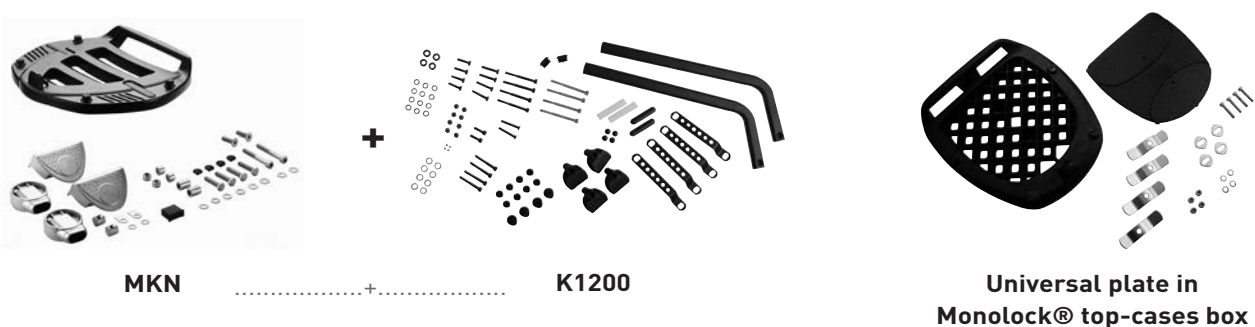

# → MOUNTING POSSIBILITIES FOR TANK BAGS

## A - FITTING ON NON-METALLIC TANKS BY MEAN OF THE BELTS INCLUDED

- 1) Bind the belts included to the frame of the motorcycle
- 2) Fit the other end of the belts to the D-ring rings on the base of the bag



## B - FITTING ON METALLIC TANKS BY MEAN OF THE TK4KIT MAGNETS KIT

- 1) Insert the 4 magnets in their seats
- 2) Fit the bag on the motorcycle tank



## C - MOUNTING POSSIBILITIES FOR SADDLE BAGS

### TUBULAR SUPPORT FOR SOFT BAGS

Available for many models of motorcycles and scooters, these tubular supports allows you to improve the stability of the soft bags during the ride, and preventing direct contact with the fairing. These tubular supports provide a valuable support for the two soft bags, also greatly improving the ease of mounting of the same

TK\_\_\_/TE\_\_\_K/TMT\_\_\_K/TST\_\_\_K/TUBULAR SIDE HOLDER

In order to facilitate the secure and stable fitting of the universal saddle bags, KAPPA has studied the specific tubular supports for various motorcycle models. The mounting of the tubular supports allows a perfect anchorage of the bags and represents an added warranty by avoiding the unpleasant damages caused by the proximity of the muffler to the bags



# GENERAL CONDITIONS OF SALE

## Definitions and Interpretation

**(a)** For the purpose of these General Conditions of Sale, the following words and terms shall have the meaning set forth below:

- "Supplier" means GIVI S.P.A., having its registered office in Flero (BS), Via Ungaretti n. 48;

- "Products" means the goods and/or services supplied by GIVI S.P.A. and covered by these General Conditions of Sale;

- "Trademark[s]" means "KAPPA" trademarks and other trademarks of which the Supplier is the owner in respect of the Products;

- "Distributor[s]" means any natural or legal person purchasing the Products for the purpose of their distribution, in accordance with these General Conditions of Sale;

- "Price List" means the official price list containing the Products' prices applied by the Supplier to the Distributor, in force at the time of the order proposal;

- "Territory" means the territory where the Distributor is authorized to sell the Products;

- "Agreement" means any agreement entered into by and between the Supplier and the Distributor in accordance with these General Conditions of Sale.

**(b)** These General Conditions of Sale shall govern the supply of the Products represented in the Price List and they shall be valid for any sale arrangements carried out through the Supplier's e-commerce platform. Use of the e-commerce platform (i.e. "KAPPA Web-Order") shall be allowed exclusively to the Distributors expressly authorized by the Supplier and provided with the required password and credentials.

**(c)** It will not be possible to proceed to an order reservation if only one single provision of the present General Conditions of Sale will not be accepted.

**(d)** The following terms and conditions are deemed to be accepted and binding for the Distributor even when the Distributor submits his order proposal through a means different from the "KAPPA Web-Order" system and they will be valid also when the contractual proposal has been submitted to the Supplier by the Distributor's local agent on his behalf. In such case the local agent will be authorized to submit the orders on the Distributor's behalf, after the Distributor's first acceptance of these General Conditions of Sale.

## 1. Scope

**1.1** These General Conditions of Sale shall apply to any supply of the Products carried out by the Supplier.

**1.2** These terms of business shall apply exclusively to any Agreement entered into by and between the Supplier and the Distributor; any Distributor's conditions that conflict with or differ from these terms of business will not be recognized unless the Supplier has specifically agreed to this in writing.

**1.3** These General Conditions of Sale and the Agreement shall be irrevocable for the Distributor.

**1.4** In the absence of a written complaint of non-conformity by the Distributor within 30 (thirty) days from the receipt of the Products, the deliveries dispatched by the Supplier are deemed to be fully accepted, despite differing from what indicated in the order confirmation with regard to the Products' types, quantity or commercial conditions.

## 2. Orders and Specifications

**2.1** The range shown on the Supplier's web-site, "Web-Order" system and online or printed catalogue does not represent a legally binding offer but a non-binding online or printed catalogue.

**2.2** The Distributor will order the Products required by accessing the reserved "Web-Order" area or via fax/e-mail. Submission of an order proposal by the Distributor implies the consent to receive the Supplier's communications described below which are exclusively aimed to the conclusion and the performance of the Agreement. No order submitted by the Distributor shall be deemed to be accepted by the Supplier unless and until confirmed in writing by the Supplier. Once the order proposal has been received,

the Supplier will transmit his order confirmation to the Distributor at the e-mail address indicated by the Distributor that will be then assigned an Order Protocol Number to be used for any subsequent communication with the Supplier. Confirmed orders will be accessible through the Distributor's personal "Web-Order" area.

**2.3** Any purchase order placed by the Distributor shall be intended as full and complete acceptance of the present General Conditions of Sale that the Distributor declares to have read and understood.

**2.4** The Supplier reserves the right to refuse an order fully or partially according to stock availability, production capability and delivery date required by the Distributor.

## 3. Prices, Invoice, Payment

**3.1** Prices to be paid by the Distributor to the Supplier for the Products are those resulting from the Price List, as established by the Supplier from time to time. All prices are in Euro (VAT is not due, therefore not included) and can be subject to modification with a 15-day prior notice from the Supplier. All prices are intended for Products delivered EX-WORKS "Incoterms® ICC 2010" (from our warehouse in Barbariga, Italy).

**3.2** Invoices must be paid within their expiry date. In case one or more invoices are expired and remain unpaid, or the maximum exposure limit is reached or exceeded, the Supplier shall be entitled to suspend any further deliveries to the Distributor until the overdue payment is received in full. Payments received need to be confirmed by the Supplier's Bank, when credited on the Supplier's bank account.

**3.3** In case of delayed payment or non-payment, without prejudice to any other right or remedy available, the Supplier shall be entitled to apply default interests on arrears as established by "Decreto Legislativo n. 231/2002" (Legislative Decree n. 231/2002) and expenses at the bank rates in force from time to time.

## 4. Packaging and Shipment

**4.1** A packaging cost contribution is charged by the Supplier in each invoice and calculated based on the number of cartons needed to contain and protect the Products during the transportation.

**4.2** Transport is entrusted to third parties if not specified to the contrary from time to time. Shipments are not prepared on pallets unless specifically requested by the Distributor. The cost of the pallets, if used, is charged by the Supplier on the invoice to the Distributor. In any case, shipments will be at the risk of the Distributor, which will also incur all the relevant costs.

**4.3** Transport obligations, costs and risks are transferred from the Supplier to the Distributor when the Products are at the disposal of the Distributor at the Supplier's warehouse.

## 5. Delivery of the Products

**5.1** The Distributor and the Supplier agree and acknowledge that the place of delivery of the Products is at the Supplier's logistic centre in Barbariga (BS), Italy.

**5.2** No claim for missing or damaged Products can be accepted by the Supplier past 8 (eight) days after the delivery of the Products.

**5.3** Time of delivery is not of the essence. The Supplier will do every effort to meet the delivery time requested by the Distributor in the order, provided that in no case the Supplier shall be liable for any delay that may occur in fulfilling accepted orders, except for its gross negligence or willful misconduct.

## 6. Custom Duties and Licenses

**6.1** The Distributor will be liable for import custom duties, if applicable in his Country, and for any other amounts payable in connection with importation and delivery of the Products.

**6.2** The Distributor shall be responsible for obtaining any necessary import licenses, permits or authorization necessary for importation and delivery of the Products.

## 7. Order cancellation

**7.1** No order which has been accepted and confirmed by the Supplier may be cancelled by the Distributor except with the agreement in writing of the Supplier and on terms that the request for order cancellation shall be submitted by the Distributor before the start of the shipment preparation. In case the order is cancelled after the shipment preparation has started, the Supplier will be entitled to invoice to the Distributor the costs incurred by the Supplier.

## 8. Property and Custody

**8.1** Notwithstanding delivery and the passing of risk in the Products, the property in the Products shall not pass to the Distributor until the Supplier has received payment in full of the price of the Products and the Distributor has fully performed all of the terms and conditions hereof.

**8.2** Before transfer of ownership, the Distributor will only be entitled to these Products with the prior written approval of the Supplier. If a third party seizes the Products, particularly if the Products are impounded, the Distributor must inform the Supplier immediately in writing and also point out to the third party immediately that the Supplier has proprietary rights.

**8.3** Until payment in full of the price, the Distributor shall be liable for the risks related to the custody and preservation of the purchased Products.

## 9. Returns

**9.1** Products may be returned to the Supplier in case of shipping irregularities, defects at the source or caused by transport, defects falling within the warranty terms. Returns shall be previously authorized by the Supplier's competent office. No Products will be accepted for credit when returned without the written permission of the Supplier. No Products will be accepted for credit after 1 (one) year from the date of shipment.

**9.2** Should the written permission be given the Products must be returned to the Supplier at the Distributor's costs, save where otherwise agreed. The authorization number released by the Supplier's competent office must be shown in the transport document together with the number of the original invoice concerning the item being returned.

**9.3** The Supplier undertakes to withdraw or replace: a) Products erroneously delivered to the Distributor under the direct responsibility of its personnel assigned to shipments; b) original defective items/components, or items/components damaged by transport, provided that the defect has been denounced within 15 (fifteen) days from the receipt of the Products; c) defective items/components falling within the warranty terms.

**9.4** Any returns not complying with the abovementioned conditions will be treated as a repair bill with application of the relative fares.

## 10. Warranties and Liability

**10.1** The warranty period is 24 (twenty-four) months and begins when the Products are handed over to the final user. Defects in the Products will be corrected by the Supplier after being informed of this by the Distributor within this warranty period, provided that the defective Products have been correctly used in a way compatible with the instructions contained in the Instruction Manual. The Supplier will decide whether to replace or repair the Products and inform the Distributor accordingly. In case of breakage falling within the warranty terms, only the component considered to be defective will be replaced, not the entire item. The Supplier shall have no further liability towards the Distributor.

**10.2** Every claim must be notified by the Distributor to the Supplier using the Warranty Claim Form provided by the Supplier, with description of the fault and pictures showing and proving the claimed defect.

**10.3** The Supplier shall be under no liability in respect of any defect arising from fair wear and tear, willful damage, negligence, abnormal working conditions, failure to follow the Supplier's instructions, whether oral or in writing, misuse



or alteration of the Products without the Supplier's approval.

**10.4** If the complaint is unfounded the Supplier reserves the right to claim reimbursement of the costs incurred from the Distributor, if any.

**10.5** The Supplier shall be under no liability under the above warranty (or any other warranty, condition or guarantee) if the total price for the Products has not been paid by the due date for payment.

**10.6** Except in respect of death or personal injury caused by the Supplier's negligence, the Supplier shall not be liable to the Distributor by reason of any representation, unless fraudulent, or any implied warranty, condition or other term, or any duty at common law, or under the express terms of the present General Conditions of Sale, for any indirect, special or consequential loss or damage, whether for loss of profit or otherwise, costs, expenses or other claims for compensation whatsoever (whether caused by the negligence of the Supplier, its employees or agents or otherwise) which arise out of or in connection with the supply of the Products or their use or resale by the Distributor, and the entire liability of the Supplier under or in connection with the sale of the Products shall not exceed the price of the Products, except as expressly provided in these General Conditions of Sale.

**10.7** The Supplier shall not be liable to the Distributor or be deemed to be in breach of these General Conditions of Sale by reason of any delay in performing, or any failure to perform, any of the Supplier's obligations in relation to the Products, if the delay or failure was due to any cause beyond the Supplier's reasonable control.

#### 11. Distributor's Undertakings

**11.1** The Distributor agrees and undertakes to sell the Products in his own name and on his own account. The Distributor shall have no authority to conclude agreements in the Supplier's behalf or to bind the Supplier towards third parties in any way. In the performance of his activities, the Distributor undertakes to act diligently, by maintaining an appropriate conduct in order to ensure compliance with the obligations arising out of these General Conditions of Sale and to preserve the quality and reputation of the Products.

**11.2** The Distributor undertakes to sell the Products only within the Territory. In particular, the Distributor undertakes not to actively sell the Products in territories reserved by the Supplier to himself or to other distributors on an exclusive basis, however it being understood that the Distributor shall have the right to fulfil orders it has not solicited, even if they come from customers residing outside the Territory. In this regard, the Distributor declares to be aware that the Products subject to these General Conditions of Sale, as included in the Price List, are designed in accordance with the legislation in force in the Territory: it follows that the possible entry of the Products in markets outside the Territory may be in contrast with the laws of these Countries.

In case of non-compliance with the commitments provided by this article, the Distributor assumes sole and full liability for any resulting damage and/or claim for compensation, thus totally declining the Supplier from any related responsibility.

**11.3** The Distributor is free to determine the resale price of the Products, without prejudice to the Supplier's faculty to

recommend a non-binding price. The Distributor agrees to use his best endeavors to promote and sell the Products, also via e-commerce platforms, in line with the Supplier's qualitative standards, in a way capable of preserving the value of the Trademarks and the technical features, prestige and reputation of the Products.

#### 12. Use of Trademarks, Confidentiality, Promotional activities

**12.1** The Distributor acknowledges that the Trademarks and other related rights are the sole property of the Supplier. Therefore, the Distributor acknowledges and accepts that only the Supplier is entitled to apply for registration of the Trademarks or of the correspondent trade names, and undertakes not to register in the future any trademark or trade name which may be considered similar to any of the Supplier's Trademarks or trade names to the extent that it may create confusion among the customers.

**12.2** The Distributor undertakes to immediately bring to the notice of the Supplier any improper or wrongful use of the Trademarks or infringement of the Supplier's industrial and/or intellectual property rights, as well as any act of unfair competition.

**12.3** The Distributor undertakes to observe total confidentiality and to abstain from using and/or divulging, also after termination of the Agreement, any commercial secrets and information of a confidential nature concerning the Supplier and the Products, exchanged during the contractual relationship between the Supplier and the Distributor.

**12.4** The Distributor shall submit to the Supplier all promotional-advertising initiatives regarding the Products for his prior written approval. In any case, any advertising or promotional operations – including attendance at fairs and exhibitions – must be submitted to the Supplier in advance to assess their compatibility with the Supplier's sale and image policy.

#### 13. Termination of the Agreement

**13.1** The Supplier may terminate the Agreement with immediate effect by written notice to the Distributor, in the event of violation of any of the following provisions: 3.3; 8; 10; 11.2; 12; 16.2.

**13.2** Any relaxation, leniency or indulgence which the Supplier may extend to the Distributor shall not in any way constitute a waiver of the Supplier's rights in terms hereof.

#### 14. Data protection

**14.1** If it has not been agreed to the contrary, the Supplier will only use the Distributor's data in order to carry out the Agreement. The Distributor's permission is required to use this information for market and opinion research and for advertising.

#### 15. Term

15.1 These General Conditions of Sale shall be effective as of the date of signature by the Distributor and they will apply to any subsequent transactions between the Supplier and the Distributor.

#### 16. Miscellaneous

**16.1** Changes and amendments to these General Conditions of Sale must be in writing to be effective. There are no verbal secondary agreements.

**16.2** If it has not been agreed to the contrary, the Distributor may not transfer rights and obligations derived from the Agreement to a third party without the Supplier's prior written consent.

**16.3** If any provision of these General Conditions of Sale is or becomes invalid or unenforceable in whole or in part, the other provisions and the remainder of the provision in question shall not be affected. The contractual partners will agree to replace the invalid provision with a valid one that best corresponds to the economic aims of the contractual parties.

**16.4** The present General Conditions of Sale and the Agreement are governed by the laws of Italy.

**16.5** The competent courts of the place where the Supplier has his registered office (Brescia, Italy) shall have exclusive jurisdiction in any action arising out of or in connection with these General Conditions of Sale and with the Agreement. However, as an exception to the principle here above, the Supplier is in any case entitled to bring his action before the competent court of the place where the Distributor has his registered office. Should the Distributor have his seat out of the EU, all disputes arising out of or in connection with the present General Conditions of Sale shall be finally settled under the Rules of Arbitration of the Chamber of Arbitration of Milan by one or more arbitrators appointed in accordance with the said Rules.

#### Final Provisions

**(a)** The Supplier is under no responsibility in respect of completeness, correctness and updating of the Price List and the catalogues;

**(b)** The Supplier reserves the right to modify, add or remove any of the represented Products without any prior notice;

**(c)** Notwithstanding the Supplier's performance of tests and safety controls over the Products, the Supplier cannot guarantee compliance of the Products with the prescriptions or installation limits actually or potentially provided by the laws of certain Countries. It shall therefore be in the Distributor's exclusive liability to verify the conformity of the Products and of their installations to the laws of his Country or any other Country, thereby declining the Supplier from any related responsibility.

**(d)** Installation of our specific articles for motor vehicles is guaranteed only if the vehicle is not provided with after-market accessories or original optional accessories of the production company.

GIVI S.P.A.  
VIA UNGARETTI, 48 – 25020 FLERO (BS)

The solutions photographed in this price list are examples of the range and KAPPA representative only. KAPPA reserve the right to modify wholly or in part, to add or remove products without prior notice.

Check the traffic laws of your own country before using the stop-light kit on public roads.



# MOTORCYCLE ACCESSORIES 2019

→ EXPORT APPLICATION CHART  
03/2019



T. +39 030 26 86 970  
F. +39 030 35 81 444

export@kappamoto.com  
www.kappamoto.com

#RIDEYOURLIFE